

α33 α55

SONY®

Interchangeable Lens  
Digital Camera

α33 α55

Instruction Manual

A-mount

Preparing the camera

Before your operation

Shooting images

Using the shooting function

Using the viewing function

Changing your setup

Viewing images on a  
computer

Printing images

Others

Index

Additional information on this product and answers to frequently asked questions can be found at our Customer Support Website.

<http://www.sony.net/>

Printed using VOC (Volatile Organic Compound)-free vegetable oil based ink.

© 2010 Sony Corporation Printed in Thailand



4187045130

α

SLT-A33/SLT-A55/SLT-A55V

## Owner's Record

The model and serial numbers are located on the bottom.

Record the serial number in the space provided below.

Refer to these numbers whenever you call upon your Sony dealer regarding this product.

Model No. SLT-A55/A55V/A33

Serial No. \_\_\_\_\_

## WARNING

**To reduce fire or shock hazard, do not expose the unit to rain or moisture.**

# IMPORTANT SAFETY INSTRUCTIONS SAVE THESE INSTRUCTIONS. DANGER - TO REDUCE THE RISK OF FIRE OR ELECTRIC SHOCK, CAREFULLY FOLLOW THESE INSTRUCTIONS.

If the shape of the plug does not fit the power outlet, use an attachment plug adaptor of the proper configuration for the power outlet.

## Caution

### Battery pack

If the battery pack is mishandled, the battery pack can burst, cause a fire or even chemical burns. Observe the following cautions.

- Do not disassemble.
- Do not crush and do not expose the battery pack to any shock or force such as hammering, dropping or stepping on it.
- Do not short circuit and do not allow metal objects to come into contact with the battery terminals.
- Do not expose to high temperature above 60°C (140°F) such as in direct sunlight or in a car parked in the sun.
- Do not incinerate or dispose of in fire.
- Do not handle damaged or leaking lithium ion batteries.
- Be sure to charge the battery pack using a genuine Sony battery charger or a device that can charge the battery pack.

- Keep the battery pack out of the reach of small children.
- Keep the battery pack dry.
- Replace only with the same or equivalent type recommended by Sony.
- Dispose of used battery pack promptly described the instructions.

### Battery charger

Even if the CHARGE lamp is not lit, the battery charger is not disconnected from the AC power source (mains) as long as it is connected to the wall outlet (wall socket). If some trouble occurs while using the battery charger, immediately shut off the power by disconnecting the plug from the wall outlet (wall socket).

When a power cord (mains lead) is supplied, the power cord (mains lead) can be used with this unit only, and should not be used with any other unit.

## For Customers in the U.S.A. and Canada

### RECYCLING LITHIUM-ION BATTERIES

Lithium-Ion batteries are recyclable.

You can help preserve our environment by returning your used rechargeable batteries to the collection and recycling location nearest you.



For more information regarding recycling of rechargeable batteries, call toll free 1-800-822-8837, or visit <http://www.rbrcl.org/>

**Caution:** Do not handle damaged or leaking Lithium-Ion batteries.

### Battery pack

This device complies with Part 15 of the FCC Rules, Operation is subject to the following two conditions:

- (1) This device may not cause harmful interference, and (2) this device must

accept any interference received, including interference that may cause undesired operation.

This Class B digital apparatus complies with Canadian ICES-003.

## For Customers in the U.S.A.

UL is an internationally recognized safety organization.

The UL Mark on the product means it has been UL Listed.

If you have any questions about this product, you may call:

Sony Customer Information Services  
Center  
1-800-222-SONY (7669)

The number below is for the FCC related matters only.

## Regulatory Information

Declaration of Conformity  
Trade Name: SONY  
Model No.: SLT-A55V  
Responsible Party: Sony Electronics  
Inc.  
Address: 16530 Via Esprillo,  
San Diego, CA 92127 U.S.A.  
Telephone No.: 858-942-2230

This device complies with Part 15 of the FCC Rules. Operation is subject to the following two conditions: (1) This device may not cause harmful interference, and (2) this device must accept any interference received, including interference that may cause undesired operation.

Declaration of Conformity  
Trade Name: SONY  
Model No.: SLT-A33  
Responsible Party: Sony Electronics  
Inc.  
Address: 16530 Via Esprillo,  
San Diego, CA 92127 U.S.A.  
Telephone No.: 858-942-2230

This device complies with Part 15 of the FCC Rules. Operation is subject to the following two conditions: (1) This device may not cause harmful interference, and (2) this device must accept any interference received, including interference that may cause undesired operation.

## CAUTION

You are cautioned that any changes or modifications not expressly approved in this manual could void your authority to operate this equipment.

## Note:

This equipment has been tested and found to comply with the limits for a Class B digital device, pursuant to Part 15 of the FCC Rules.

These limits are designed to provide reasonable protection against harmful interference in a residential installation. This equipment generates, uses, and can radiate radio frequency energy and, if not installed and used in accordance with the instructions, may cause harmful interference to radio communications. However, there is no guarantee that interference will not occur in a particular installation. If this equipment does cause harmful interference to radio or television reception, which can be determined by turning the equipment off and on, the user is encouraged to try to correct the interference by one or more of the following measures:

- Reorient or relocate the receiving antenna.
- Increase the separation between the equipment and receiver.
- Connect the equipment into an outlet on a circuit different from that to which the receiver is connected.
- Consult the dealer or an experienced radio/TV technician for help.

The supplied interface cable must be used with the equipment in order to comply with the limits for a digital device pursuant to Subpart B of Part 15 of FCC Rules.



## For Customers in Europe



Hereby, Sony Corporation, declares that this SLT-A55V Interchangeable Lens Digital Camera is in compliance with the essential requirements and other relevant provisions of the Directive 1999/5/EC. For details, please access the following URL: <http://www.compliance.sony.de/>

### Notice for the customers in the countries applying EU Directives

The manufacturer of this product is Sony Corporation, 1-7-1 Konan Minato-ku Tokyo, 108-0075 Japan. The Authorized Representative for EMC and product safety is Sony Deutschland GmbH, Hedelfinger Strasse 61, 70327 Stuttgart, Germany. For any service or guarantee matters please refer to the addresses given in separate service or guarantee documents.

This product has been tested and found compliant with the limits set out in the EMC Directive for using connection cables shorter than 3 meters (9.8 feet).

### Attention

The electromagnetic fields at the specific frequencies may influence the picture and sound of this unit.

### Notice

If static electricity or electromagnetism causes data transfer to discontinue midway (fail), restart the application or disconnect and connect the communication cable (USB, etc.) again.

### Disposal of Old Electrical & Electronic Equipment (Applicable in the European Union and other European countries with separate collection systems)



This symbol on the product or on its packaging indicates that this product shall not be treated as household waste. Instead it shall be handed over to the applicable collection point for the recycling of electrical and electronic equipment. By ensuring this product is disposed of correctly, you will help prevent potential negative consequences for the environment and human health, which could otherwise be caused by inappropriate waste handling of this product. The recycling of materials will help to conserve natural resources. For more detailed information about recycling of this product, please contact your local Civic Office, your household waste disposal service or the shop where you purchased the product.

## Disposal of waste batteries (applicable in the European Union and other European countries with separate collection systems)



This symbol on the battery or on the packaging indicates that the battery provided with this product shall not be treated as household waste.

On certain batteries this symbol might be used in combination with a chemical symbol. The chemical symbols for mercury (Hg) or lead (Pb) are added if the battery contains more than 0.0005% mercury or 0.004% lead.

By ensuring these batteries are disposed of correctly, you will help prevent potentially negative consequences for the environment and human health which could otherwise be caused by inappropriate waste handling of the battery. The recycling of the materials will help to conserve natural resources.

In case of products that for safety, performance or data integrity reasons require a permanent connection with an incorporated battery, this battery should be replaced by qualified service staff only.



To ensure that the battery will be treated properly, hand over the product at end-of-life to the applicable collection point for the recycling of electrical and electronic equipment.

For all other batteries, please view the section on how to remove the battery from the product safely. Hand the battery over to the applicable collection point for the recycling of waste batteries.

For more detailed information about recycling of this product or battery, please contact your local Civic Office, your household waste disposal service or the shop where you purchased the product.

## Notice for customers in the United Kingdom

A moulded plug complying with BS 1363 is fitted to this equipment for your safety and convenience.

Should the fuse in the plug supplied need to be replaced, a fuse of the same rating as the supplied one and approved by ASTA or BSI to BS 1362, (i.e., marked with an  or  mark) must be used.

If the plug supplied with this equipment has a detachable fuse cover, be sure to attach the fuse cover after you change the fuse.

Never use the plug without the fuse cover. If you should lose the fuse cover, please contact your nearest Sony service station.

# Notes on using your camera

## Shooting procedure

- This camera has two modes for shooting: the LCD monitor mode using the LCD monitor, and the viewfinder mode using the viewfinder.
- The recorded image may be different from the image you monitored before recording.

## Notes on the functions available with the camera

- To check whether it is a 1080 60i-compatible device or 1080 50i-compatible device, check for the following marks on the bottom of the camera.  
1080 60i-compatible device:60i  
1080 50i-compatible device:50i
- You may feel uncomfortable symptoms such as eyestrain, nausea, or a tired feeling while watching 3D-images recorded with the camera on 3D-compatible monitors. When you watch 3D-images, we recommend that you take a break at regular time intervals. Since the need for or frequency of break times varies between individuals, please set your own standards. If you feel sick, stop watching 3D-images, and consult a doctor as needed. Also, refer to the operating instructions of the connected device or the software used with the camera. A child's vision is always vulnerable (especially for children under six years of age). Before allowing them to watch 3D-images, please consult with an expert, such as a pediatric or ophthalmic doctor. Be sure to make sure your children follow the precautions above.

## No compensation for contents of the recording

The contents of the recording cannot be compensated for if recording or playback is not possible due to a malfunction of your camera or a memory card, etc.

## Back up recommendation

To avoid the potential risk of data loss, always copy (back up) data to other medium.

## Notes on the LCD monitor, electronic viewfinder, lens, and image sensor

- The LCD monitor and electronic viewfinder are manufactured using extremely high-precision technology so over 99.99% of the pixels are operational for effective use. However, there may be some tiny black points and/or bright points (white, red, blue or green in color) that constantly appear on the LCD monitor and electronic viewfinder. These points are normal in the manufacturing process and do not affect the images in any way.
- When you change your focus on the viewfinder, red, green, or blue flickers may appear on the screen. This is not a malfunction. These flickers are not recorded on the image.
- Do not hold the camera by taking hold of the LCD monitor.
- Do not expose the camera to sunlight or shoot sunward for a long time. The internal mechanism may be damaged. If sunlight is focused on a nearby object, it may cause a fire.
- There is a magnet on the back and around the rotating shaft of the hinge part of the LCD monitor. Do not bring anything that is easily affected by a magnet, such as floppy disk, credit cards near the LCD monitor.
- Images may trail across on the screen in a cold location. This is not a malfunction. When turning on the camera in a cold location, the screen may become temporarily dark. When the camera warms up, the screen will function normally.

## Notes on long-time recording

- When you continue to shoot for a long time, the temperature of the camera rises. If the temperature reaches above a certain level, the [H] mark is indicated on the screen and the camera is turned off automatically. If the power is turned off, leave the camera for 10 minutes or longer to allow the temperature inside the camera to decrease to a safe level.
- Under high ambient temperatures, the temperature of the camera rises quickly.
- When the temperature of the camera rises, the image quality may deteriorate. It is recommended that you wait until the temperature of the camera drops before continuing to shoot.
- The surface of the camera may get hot. This is not a malfunction.

## Notes when playing movies on other devices

- This camera uses MPEG-4 AVC/H.264 High Profile for AVCHD format recording. Movies recorded in AVCHD format with this camera cannot be played with the following devices.
  - Other devices compatible with AVCHD format that does not support High Profile
  - Devices incompatible with the AVCHD formatThis camera also uses MPEG-4 AVC/H.264 Main Profile for MP4 format recording. For this reason, movies recorded in MP4 format with this camera cannot be played on devices other than those that support MPEG-4 AVC/H.264.
- Discs recorded with HD image quality (high definition) can be played back only on AVCHD format-compatible devices. DVD-based players or recorders cannot play back HD image quality discs, as they are incompatible with the AVCHD format. Also, DVD-based players or recorders may fail to eject HD image quality discs.

## On GPS-compatible devices (SLT-A55V only)

- To determine whether your camera supports GPS function, check the model name of your camera.
  - GPS-compatible: SLT-A55V
  - GPS-incompatible: SLT-A55/A33
- Use GPS in accordance with regulations of countries and regions where you use it.
- If you do not record the location information, set [GPS On/Off] to [Off] (page 138).
- In an airplane, make sure to turn off the camera following cabin announcements.

## Warning on copyright

Television programs, films, videotapes, and other materials may be copyrighted. Unauthorized recording of such materials may be contrary to the provisions of the copyright laws.

## The pictures used in this manual



The photographs used as examples of pictures in this manual are reproduced images, and are not actual images shot using this camera.

## On the data specifications described in this Instruction Manual

The data on performance and specifications is defined under the following conditions, except as described in this Instruction Manual: at an ordinary ambient temperature of 25°C (77°F), and using a battery pack that is charged for about an hour after the CHARGE lamp goes out.

# Table of Contents

|                              |   |    |
|------------------------------|---|----|
|                              | Notes on using your camera .....  | 7  |
| <b>Preparing the camera</b>  | Checking the accessories supplied .....   | 13 |
|                              | Identifying parts .....   | 14 |
|                              | Charging the battery pack .....   | 18 |
|                              | Inserting the battery pack/memory card (sold separately)<br>.....   | 20 |
|                              | Attaching a lens .....  | 26 |
|                              | Preparing the camera .....  | 28 |
|                              | Using the accessories supplied .....  | 30 |
|                              | Checking the number of recordable images .....  | 32 |
|                              | Cleaning .....  | 35 |
| <b>Before your operation</b> | Screen indicators .....   | 39 |
|                              | Switching the screen mode between the LCD monitor<br>and the electronic viewfinder .....  | 39 |
|                              | Switching the recording information display (DISP)<br>.....   | 40 |
|                              | Recording information display (Graphic Display/<br>Recording information (For Live View)) .....   | 42 |
|                              | Recording information display (For viewfinder) .....  | 44 |
|                              | Selecting a function/setting .....  | 46 |
|                              | Selecting a function with the Fn (Function) button ...  | 47 |
|                              | The functions selected by the Fn (Function) button ...  | 48 |
|                              | The functions selected by the MENU button .....   | 49 |
| <b>Shooting images</b>       | Adjusting the angle of the LCD monitor .....  | 55 |
|                              | Shooting an image without camera shake .....  | 56 |
|                              | Correct posture .....   | 56 |
|                              | Using the SteadyShot function .....   | 57 |
|                              | Using a tripod .....  | 58 |
|                              | Shooting with the automatic setting .....   | 59 |
|                              | <b>AUTO</b> /  Shooting with appropriate settings<br>automatically ..... | 59 |
|                              | <b>AUTO+</b> Shooting with the settings that the camera adjusts<br>automatically .....  | 61 |

|   |     |
|---|-----|
| Shooting with a suitable setting for the subject .....  | 63  |
| SCN Shooting with preset settings according to the scene<br>(Scene Selection) .....   | 63  |
|  Shooting panoramic images (Sweep Shooting) .  | 66  |
|  /  Shooting continuously at high speed (Continuous<br>Advance Priority AE) ..... | 69  |
| Shooting an image the way you want it (Exposure mode)<br>.....  | 70  |
| P Shooting with program auto .....  | 71  |
| A Shooting by controlling the blur of the background<br>(Aperture priority) .....   | 72  |
| S Shooting a moving subject with various expressions<br>(Shutter speed priority) .....  | 75  |
| M Shooting with the exposure adjusted manually<br>(Manual exposure) .....   | 77  |
| M Shooting trails with long exposure (BULB) .....   | 79  |
| Recording movies .....  | 81  |
| Available recording time for a movie .....  | 83  |
| Notes on continuous movie recording .....   | 84  |
| <hr/>   |     |
| <b>Using the shooting function</b>  |     |
| Selecting the focus method .....  | 85  |
| Using autofocus .....   | 85  |
| Shooting with your desired composition (Focus-lock)<br>.....  | 87  |
| Selecting the focus method to suit the movement of the<br>subject (Autofocus Mode) .....  | 88  |
| Selecting the focus area (AF area) .....  | 89  |
| Adjusting the focus manually (Manual focus) .....   | 90  |
| Checking the focus by enlarging the image .....   | 91  |
| Detecting faces .....   | 93  |
| Using the Face Detection function .....   | 93  |
| Capturing smiling faces (Smile Shutter) .....   | 94  |
| Using the flash .....   | 96  |
| Performing wireless flash shooting .....  | 99  |
| Adjusting the brightness of the image (Exposure, Flash<br>compensation, Metering) .....   | 100 |
| Shooting with fixed brightness (AE Lock) .....  | 100 |

|  |     |
|--|-----|
| Using brightness compensation for the entire image<br>(Exposure compensation) .....              | 101 |
| Adjusting the amount of flash light (Flash<br>Compensation) .....                                | 103 |
| Selecting the flash control mode to set the amount of<br>flash light (Flash control) .....       | 104 |
| Selecting the method for measuring the brightness of a<br>subject (Metering Mode) .....          | 105 |
| Setting ISO .....  | 106 |
| Compensating for the brightness and contrast automatically<br>(D-Range) .....                    | 107 |
| Correcting the brightness of the image (D-Range<br>Optimizer) .....                              | 107 |
| Compensating automatically with rich gradation (Auto<br>High Dynamic Range) .....                | 108 |
| Image processing .....   | 110 |
| Selecting your desired image processing (Creative Style)<br>.....                                | 110 |
| Changing the range of color reproduction (Color Space)<br>.....                                  | 111 |
| Adjusting the color tones (White balance) .....  | 112 |
| Adjusting the white balance to suit a specific light source<br>(Auto/Preset white balance) ..... | 112 |
| Setting the color temperature and a filter effect (Color<br>Temperature/Color Filter) .....      | 113 |
| Registering the color tones (Custom white balance) .....   | 114 |
| ☺ / 📷 Selecting the drive mode .....   | 116 |
| Shooting single shot .....   | 116 |
| Shooting continuously .....  | 116 |
| Using the self-timer .....   | 117 |
| Shooting images with the exposure shifted (Exposure<br>bracket) .....                            | 118 |
| Shooting with white balance shifted (WB bracket)<br>.....  | 119 |
| Shooting with the Wireless Remote Commander ....   | 120 |

|                                     |   |     |
|-------------------------------------|---|-----|
| <b>Using the viewing function</b>   | Playing back images .....                               | 121 |
|                                     | Checking the information of recorded images .....       | 127 |
|                                     | Protecting images (Protect) .....                       | 131 |
|                                     | Deleting images (Delete) .....                          | 132 |
|                                     | Viewing images on a TV screen .....                     | 134 |
| <b>Changing your setup</b>          | GPS setting (SLT-A55V only) .....                       | 138 |
|                                     | Setting image size and image quality .....              | 141 |
|                                     | Setting the method for recording on a memory card ..... | 145 |
|                                     | Changing the noise reduction setting .....              | 149 |
|                                     | Changing the function of the buttons .....              | 150 |
|                                     | Changing other settings .....                           | 151 |
|                                     | Setting the LCD monitor/electronic viewfinder .....     | 153 |
|                                     | Confirming the version of the camera .....              | 155 |
| Resetting to the default .....      | 156   |     |
| <b>Viewing images on a computer</b> | Using with your computer .....                          | 159 |
|                                     | Using the software .....                                | 161 |
|                                     | Connecting the camera to the computer .....             | 165 |
|                                     | Creating a movie disc .....                             | 168 |
| <b>Printing images</b>              | Specifying DPOF .....                                   | 172 |
| <b>Others</b>                       | Specifications .....                                    | 174 |
|                                     | Troubleshooting .....                                   | 179 |
|                                     | Warning messages .....                                  | 189 |
|                                     | Precautions .....                                       | 192 |
|                                     | AVCHD format .....                                      | 195 |
|                                     | GPS (SLT-A55V only) .....                               | 196 |
|                                     | 3D-shootings .....                                      | 198 |
| <b>Index</b> .....                  | <b>199</b>  |     |



# Checking the accessories supplied

The number in parentheses indicates the number of pieces.

- BC-VW1 Battery charger (1)

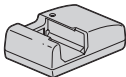

- Power cord (mains lead) (1) (not supplied in the U.S.A. and Canada)



- Rechargeable battery pack NP-FW50 (1)



- USB cable (1)



- Shoulder strap (1)

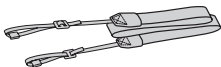

- Body cap (1) (Attached on the camera)



- Eyecup (1) (Attached on the camera)
- CD-ROM (Application Software for  $\alpha$  camera) (1)
- Instruction Manual (This manual) (1)

## Note on using the lenses and accessories

It is recommended that you use Sony lenses/accessories\* designed to suit the characteristics of this camera. Using the products of other manufacturers may cause the camera not to operate to its capability, or result in accidents and malfunctions of the camera.

\* Konica Minolta products are included.

# Identifying parts

See the pages in parentheses for details of operation.

## Front side

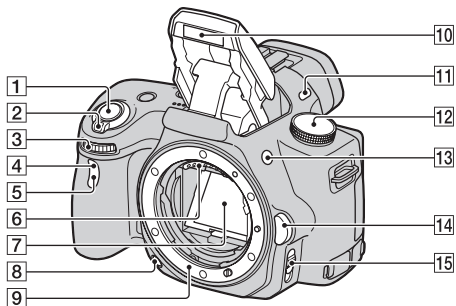

1 Shutter button (59)

2 Power switch (28)

3 Control dial (73)

4 Remote sensor

5 Self-timer lamp (117)

6 Lens contacts\*

7 Mirror\*

8 Preview button (74)

9 Mount

10 Built-in flash\* (96)

11 Microphone\*\*

12 Mode dial (59 – 80)

13 ⚡ (Flash pop-up) button (96)

14 Lens release button (27)







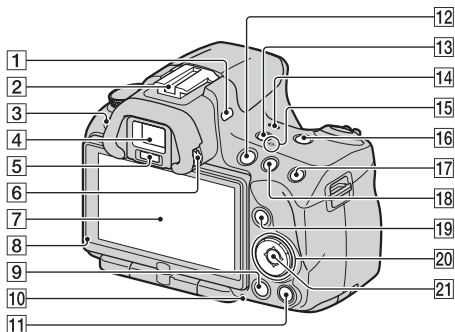

15 Focus mode switch (85, 90)

\* **Do not directly touch these parts.**

\*\* **Do not cover this part during movie recording.**

## Rear side



- 1 Microphone\*\*
- 2 Auto-lock Accessory shoe (99)
- 3 MENU button (49)
- 4 Viewfinder\* (39)
- 5 Eyepiece sensors (39)
- 6 Diopter-adjustment dial (29)
- 7 LCD monitor (42, 121, 127)
- 8 Light sensor (153)
- 9  (Playback) button (121)
- 10 Access lamp (22)
- 11 For shooting: Focus Magnifier button (91, 150)  
For viewing:  (Delete) button (132)
- 12 MOVIE button (81)
- 13 FINDER/LCD button (39, 154)
- 14 Speaker
- 15  Image sensor position mark (87)
- 16 D-RANGE (Dynamic range) button (107)
- 17 For shooting: AEL (AE lock) button (78, 100)  
For viewing:  (Zoom in) button (124)
- 18 For shooting:  (Exposure) button (101)  
For viewing:  (Zoom out) button (124)/ (Image index) button (125)
- 19 For shooting: Fn (Function) button (47, 48)  
For viewing:  (Image rotation) button (123)

**20** Control button

When the menu is turned on: ▲/

▼/◀/▶ button (46)

When the menu is turned off:

DISP (Display) (40, 121)/WB

(White balance) (112)/☺ / ☐

(Drive) (116)/ISO (106)

**21** Control button (Enter) (46)/AF

button (89)

\* **Do not directly touch these parts.**

\*\* **Do not cover this part during movie recording.**

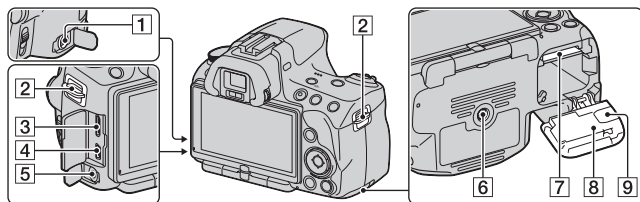

### 1 REMOTE terminal

- When connecting the RM-S1AM/RM-L1AM Remote Commander (sold separately) to the camera, insert the plug of the Remote Commander into the REMOTE terminal, aligning the guide of the plug with the guide of the REMOTE terminal. Make sure that the cord of the Remote Commander faces forward.

### 2 Hooks for shoulder strap (30)

### 3 HDMI terminal (134)

### 4 (USB) terminal (165)

### 5 Microphone jack

- When an external microphone is connected, the internal microphone is turned off automatically. When the external microphone is a plug-in-power type, the power of the microphone is supplied by the camera.

### 6 Tripod receptacle

- Use a tripod with a screw length of less than 5.5 mm (7/32 inch). You will be unable to firmly secure the camera to tripods having screws longer than 5.5 mm (7/32 inch), and may damage the camera.

### 7 Memory card insertion slot (20)

### 8 Battery/memory card cover (20)

### 9 Connection plate cover

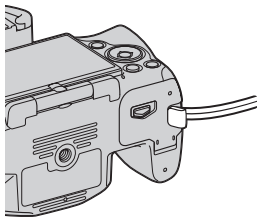

- For using the AC-PW20 AC Adaptor (sold separately) Be careful not to catch the cord of the AC Adaptor in the cover when you close the cover.

# Charging the battery pack

When using the camera for the first time, be sure to charge the NP-FW50 “InfoLITHIUM” battery pack (supplied).

The “InfoLITHIUM” battery pack can be charged even when it has not been fully depleted.

It can also be used when it has not been fully charged.

## 1 Insert the battery pack onto the battery charger.

Push the battery pack until it clicks.

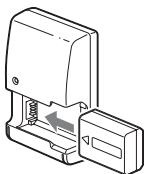

## 2 Connect the battery charger to the wall outlet (wall socket).

Light on: Charging

Light off: Charge completed

- The CHARGE lamp turns off when charging is finished.
- Time required to charge a fully depleted battery pack at a temperature of 25°C (77°F) is about 250 minutes.

For the U.S.A and Canada

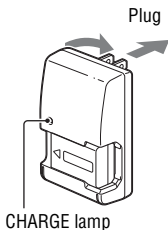

For countries/regions other than the U.S.A. and Canada

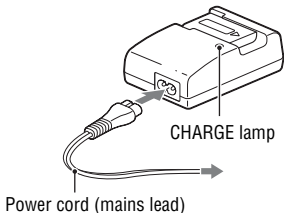

**Notes**

- The charging time differs depending on the remaining capacity of the battery pack or charging conditions.
- We recommend charging the battery pack in an ambient temperature of between 10 to 30°C (50 to 86°F). You may not be able to efficiently charge the battery pack outside of this temperature range.
- Connect the battery charger to the nearest wall outlet (wall socket).
- Do not try to charge the battery pack again right after it has been charged, or when it has not been used after being charged. Doing so will affect the performance of the battery pack.
- Do not charge any battery pack other than the “InfoLITHIUM” W series battery pack in the battery charger (supplied) with your camera. Batteries other than the specified kind may leak, overheat, or explode if you attempt to charge them, posing a risk of injury from electrocution and burns.
- When the CHARGE lamp flashes, this may indicate a battery error or that a battery pack other than the specified type has been installed. Check that the battery pack is the specified type. If the battery pack is the specified type, remove the battery pack, replace it with new one or another one and check if the battery charger operates correctly. If the battery charger operates correctly, a battery error may have occurred.
- If the battery charger is dirty, charging may not be performed successfully. Clean the battery charger with dry cloth, etc.

**To use your camera abroad — Power sources**

You can use your camera and the battery charger and the AC-PW20 AC Adaptor (sold separately) in any country or region where the power supply is within 100 V to 240 V AC, 50/60 Hz.

**Note**

- Do not use an electronic transformer (travel converter), as this may cause a malfunction.

# Inserting the battery pack/memory card (sold separately)

- 1 While sliding the cover open lever, open the cover.

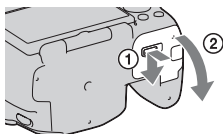

- 2 Firmly insert the battery pack all the way while pressing the lock lever with the tip of the battery.

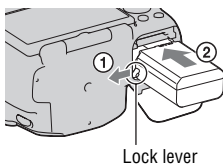

- 3 Insert a memory card.

- With the notched corner facing as illustrated, insert the memory card until it clicks into place.

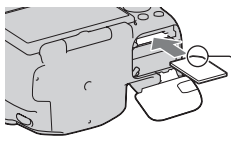

Ensure the notched corner faces correctly.

- 4 Close the cover.

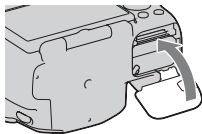



## Available memory cards

- Only “Memory Stick PRO Duo” media, “Memory Stick PRO-HG Duo” media, SD memory cards, SDHC memory cards and SDXC memory cards can be used with this camera. A MultiMediaCard cannot be used with this camera. However, proper operation cannot be guaranteed for all memory cards functions.
- The “Memory Stick PRO Duo” media and “Memory Stick PRO-HG Duo” media are referred to as the “Memory Stick PRO Duo” media and the SD memory card, SDHC memory card and SDXC memory card are referred to as the “SD card” in this Instruction Manual.
- For recording movies, it is recommended that you use following memory cards.
  - MEMORY STICK PRO DUO (Mark2) (“Memory Stick PRO Duo” media (Mark2))
  - MEMORY STICK PRO-HG DUO (“Memory Stick PRO-HG Duo” media)
  - SD memory card, SDHC memory card, SDXC memory card (Class 4 or more)
- Images recorded on an SDXC memory card cannot be imported to or played on computers or AV devices that are not compatible with exFAT. Make sure that the device is compatible with exFAT before connecting it to the camera. If you connect your camera to an incompatible device, you may be prompted to format the card. Never format the card in response to this prompt, as doing so will erase all data on the card. (exFAT is the file system used on SDXC memory cards.)

## To remove the battery pack

Turn off the camera and slide the lock lever in the direction of the arrow. Be careful not to drop the battery pack.

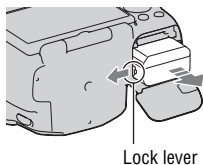

## To remove the memory card

Check that the access lamp is not lit, then open the cover, and push the memory card once.

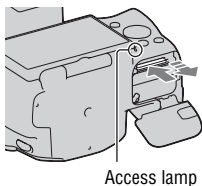

## To check the remaining battery level

Check the level with the following indicators and percent figures displayed on the screen.

|               |           |  |  |  |  |                                     |
|---------------|-----------|--|--|--|--|-------------------------------------|
| Battery level |           |  |  |  |  | <b>"Battery exhausted."</b>         |
|               | High  Low |  |  |  |  | You cannot shoot any more pictures. |

## What is an "InfoLITHIUM" battery pack?

An "InfoLITHIUM" battery pack is a lithium-ion battery pack that has functions for exchanging information related to operating conditions with your camera. Using the "InfoLITHIUM" battery pack, the remaining battery time in percent figures is displayed according to the operating conditions of your camera.

## Notes on using the battery pack

- The displayed level may not be correct under certain circumstances.
- Do not expose the battery pack to water. The battery pack is not water-resistant.
- Do not leave the battery pack in extremely hot places, such as in a car or under direct sunlight.

## Effective use of the battery pack

- Battery performance decreases in low temperature surroundings. So, the time that the battery pack can be used is shorter in cold places and the speed of continuous shooting slows down. We recommend that you put the battery pack in a pocket close to your body to warm it up, and insert it in your camera immediately before you start shooting.
- The battery pack will run out quickly if you use the flash frequently, use continuous shooting often, or turn the camera on and off frequently.

## Battery life

- The battery life is limited. Battery capacity decreases little by little as you use it more and more, and as time passes. If the battery operating time seems shortened considerably, a probable cause is that the battery pack has reached the end of its life. Buy a new battery pack.
- The battery life varies according to how it is stored and the operating conditions and environment in which each battery pack is used.

## How to store the battery pack

If the battery pack is not to be used for a long time, charge it and then fully use it up once a year on your camera before storing the battery pack in a dry, cool place to prolong the battery life.



## Notes on using memory cards

- Do not strike, bend or drop the memory card.
- Do not use or store the memory card under the following conditions:
  - High temperature locations such as the hot interior of a car parked in direct sunlight.
  - Locations exposed to direct sunlight.
  - Humid locations or locations with corrosive substances present.
- The memory card may be hot just after it has been used for a long time. Be careful when you handle it.
- When the access lamp is lit, do not remove the memory card or the battery pack, or turn off the power. The data may be corrupted.
- Data may be damaged if you place the memory card near strongly-magnetized material or use the memory card in a static-prone or electrically noisy environment.

- We recommend backing up important data, such as to a hard disk of a computer.
- When you carry or store the memory card, put it in the case supplied with it.
- Do not expose the memory card to water.
- Do not touch the terminal section of the memory card with your hand or a metal object.
- When the write-protect switch of a memory card is set to the LOCK position, you cannot perform operations, such as recording or deleting images.
- The memory cards formatted with a computer are not guaranteed to operate with this camera. Be sure to format the memory cards using the camera.
- Data read/write speeds differ depending on the combination of the memory cards and the equipment used.
- Do not press down hard when you write down on the memo area.
- Do not attach a label on the memory cards themselves.
- Do not disassemble or modify the memory cards.
- Do not leave the memory cards within the reach of small children. They might accidentally swallow it.

## Notes on the “Memory Stick” media used with the camera

The types of “Memory Stick” media that can be used with this camera are listed in the table below. However, proper operation cannot be guaranteed for all “Memory Stick PRO Duo” media functions.

|   |                              |   |
|---|------------------------------|---|
| <b>“Memory Stick PRO Duo” media</b> <sup>*1</sup> <sup>*2</sup> <sup>*3</sup> | Available with your camera   |  |
| <b>“Memory Stick PRO-HG Duo” media</b> <sup>*1</sup> <sup>*2</sup>            |                              |   |
| <b>“Memory Stick Duo” media</b>   | Unavailable with your camera |  |
| <b>“Memory Stick” media and “Memory Stick PRO” media</b>                      | Unavailable with your camera |  |

\*1 This is equipped with MagicGate function. MagicGate is copyright protection technology that uses encryption technology. Data recording/playback that requires MagicGate functions cannot be performed with this camera.

\*2 Supports high-speed data transfer using a parallel interface.

\*3 When using “Memory Stick PRO Duo” media to record movies, only those marked with Mark2 can be used.

## Notes on using “Memory Stick Micro” media (sold separately)

- This product is compatible with “Memory Stick Micro” media (“M2”). “M2” is an abbreviation for “Memory Stick Micro” media.
- To use a “Memory Stick Micro” media with the camera, be sure to insert the “Memory Stick Micro” media into an “M2” Adaptor as large as of Duo size. If you insert a “Memory Stick Micro” media into the camera without an “M2” Adaptor as large as of Duo size, you might not be able to remove it from the camera.
- Do not leave the “Memory Stick Micro” media within the reach of small children. They might accidentally swallow it.

# Attaching a lens

---

## 1 Remove the body cap from the camera and the packaging lid from the rear of the lens.

- When changing the lens, quickly change the lens away from dusty locations so as to keep dust or debris from getting inside the camera.

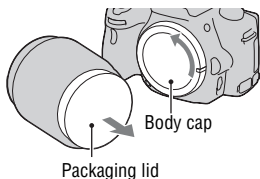

## 2 Mount the lens by aligning the orange index marks on the lens and camera.

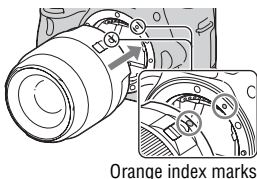

## 3 Turn the lens clockwise until it clicks into the locked position.

- Be sure to put the lens on straight.

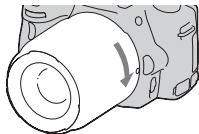

---

### Notes

- When attaching a lens, do not press the lens release button.
- Do not use force when attaching a lens.
- E-mount lenses are not compatible with this camera.
- When you use a lens for which a tripod socket is provided, attach the lens onto the tripod using the tripod socket provided to help balance the weight of the lens.

## To remove the lens

- 1 Press the lens release button all the way in and turn the lens counterclockwise until it stops.**

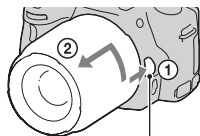

Lens release button

- 2 Replace the packaging lid on the lens and attach the body cap to the camera.**

- Before you attach them, remove dust from them.
- A rear lens cap is not supplied with the DT 18-55mm F3.5-5.6 SAM Lens Kit. When you store the lens without attaching it to the camera, purchase the Rear Lens Cap ALC-R55.

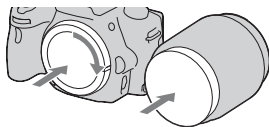

### Note on changing the lens

When changing the lens, if dust or debris gets inside the camera and lands on the surface of the image sensor (the part that acts as the film), it may appear on the image, depending on the shooting environment. The camera is equipped with an anti-dust function to prevent dust from landing on the image sensor. However, quickly change the lens away from dusty locations when attaching/removing a lens.

### If dust or debris lands on the image sensor

Clean the image sensor using [Cleaning Mode] in the  Setup menu (page 36).

# Preparing the camera

## Setting up the date

When you turn the camera on for the first time, the date/time setup screen appears.

### 1 Set the power switch to ON to turn the camera on.

The screen used for setting date and time appears.

- To turn the camera off, set it to OFF.

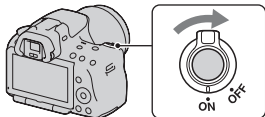

### 2 Verify that [Enter] is selected on the LCD monitor, then press the center of the control button.

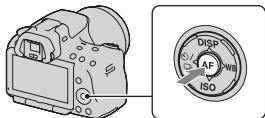

### 3 Select your area with ◀/▶ on the control button, then press the center of the control button.

### 4 Select each item with ◀/▶ and set the numeric value with ▲/▼.

**[Daylight Svg.]:** Turns on or off the daylight saving time setting.

**[Date Format]:** Selects the format to display date.

- Midnight is indicated as 12:00 AM, and noon as 12:00 PM.



| Date/Time Setup                 |                                    |
|---------------------------------|------------------------------------|
| Daylight Svg.:                  | <input type="checkbox"/> *Off      |
| 2010 - 1 - 1                    | 12 : 00 AM                         |
| Date Format:                    | <input type="checkbox"/> Y - M - D |
| ◀ Select    ▲ Adjust    ● Enter |                                    |



---

**5 Repeat step 4 to set other items, then press the center of the control button.**

---

**6 Verify that [Enter] is selected, then press the center of the control button.**

---

### To cancel the date/time setting operation

Press the MENU button.

### To set up the date/time again

When you turn the camera on for the first time, the date/time setup screen appears automatically. The next time, set up the date and time from the menu.

**MENU button** →  **1** → **[Date/Time Setup]**

### To set up the area again

You can set the area where you are using the camera. This allows you to set the local area when you use the camera abroad.

**MENU button** →  **1** → **[Area Setting]**

### Maintaining the date and time setting

This camera has an internal rechargeable battery for maintaining the date and time and other settings regardless of whether the power is on or off, or the battery is installed or not. For details, see page 192.

## Adjusting the focus of the finder (diopter adjustment)

**Adjust the diopter-adjustment dial to your eyesight until the display appears clearly in the viewfinder.**

- Training the camera on a light allows you to adjust the diopter easily.

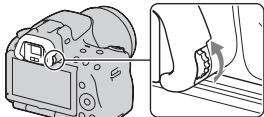

### Note

- The dioptic adjustment attachment (sold separately) cannot be used with this camera.

# Using the accessories supplied

This section describes how to use the shoulder strap and eyecup. The other accessories are described in the following pages.

- Rechargeable battery pack (page 18)
- Battery charger (page 18)
- Power cord (mains lead) (not supplied in the U.S.A. and Canada) (page 18)
- USB cable (page 165)
- CD-ROM (page 161)

## Attaching the shoulder strap

**Attach both ends of the strap onto the camera.**

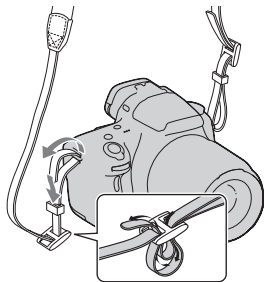

## Removing the eyecup

When attaching the FDA-A1AM Angle Finder (sold separately) to the camera, remove the eyecup.

**Carefully slide the eyecup off by pushing on each side of the eyecup.**

- Put your fingers under the eyecup, and slide it upward.

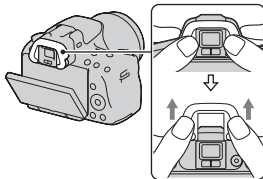

### Note

- The Magnifier and Magnifying Eyepiece cannot be used with this camera.

# Checking the number of recordable images

Once you insert a memory card into the camera and set the power switch to ON, the number of images that can be recorded (should you continue to shoot using the current settings) is displayed on the screen.

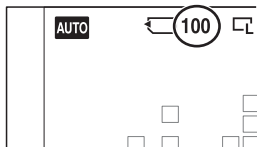

## Notes

- When “0” (the number of recordable images) flashes in yellow, the memory card is full. Replace the memory card with another one, or delete images in the current memory card (page 132).
- When “NO CARD” (the number of recordable images) flashes in yellow, it means no memory card has been inserted. Insert a memory card.

## The number of images that can be recorded on a memory card

The table shows the approximate number of images that can be recorded on a memory card formatted with this camera. The values are defined using Sony standard memory cards for testing. The values may vary depending on the shooting conditions and the type of memory card used.

**Image: Size: L 16M (SLT-A55/A55V)/L 14M (SLT-A33)**

**Image: Aspect Ratio: 3:2\***

**“Memory Stick PRO Duo”**

**SLT-A55/A55V**

**(Units: Images)**

| Capacity<br>Size | 2GB | 4GB | 8GB  | 16GB | 32GB |
|------------------|-----|-----|------|------|------|
| Standard         | 386 | 781 | 1587 | 3239 | 6406 |
| Fine             | 270 | 548 | 1116 | 2279 | 4510 |
| RAW & JPEG       | 74  | 154 | 319  | 657  | 1304 |
| RAW              | 106 | 220 | 452  | 928  | 1840 |

| Capacity<br>Size | 2GB | 4GB | 8GB  | 16GB | 32GB |
|------------------|-----|-----|------|------|------|
| Standard         | 433 | 875 | 1778 | 3626 | 7172 |
| Fine             | 305 | 618 | 1258 | 2569 | 5083 |
| RAW & JPEG       | 84  | 176 | 362  | 745  | 1478 |
| RAW              | 122 | 251 | 514  | 1054 | 2089 |

\* When [Image: Aspect Ratio] is set to [16:9], you can record more images than the numbers shown in the table above (except when [RAW] is selected).

## The number of images that can be recorded using a battery pack

The approximate number of images that can be recorded is as follows when you use the camera with the battery pack (supplied) at full capacity. Note that the actual numbers may be less than those indicated depending on the conditions of use.

### With the flash

|                         | SLT-A55            | SLT-A55V           | SLT-A33            |
|-------------------------|--------------------|--------------------|--------------------|
| <b>LCD monitor mode</b> | Approx. 390 images | Approx. 380 images | Approx. 340 images |
| <b>Viewfinder mode</b>  | Approx. 350 images | Approx. 330 images | Approx. 270 images |

### Without the flash

|                         | SLT-A55            | SLT-A55V           | SLT-A33            |
|-------------------------|--------------------|--------------------|--------------------|
| <b>LCD monitor mode</b> | Approx. 450 images | Approx. 430 images | Approx. 380 images |
| <b>Viewfinder mode</b>  | Approx. 380 images | Approx. 370 images | Approx. 290 images |

- The number is calculated with a battery pack at full capacity and in the following situation:
  - At an ambient temperature of 25°C (77°F).
  - Using the battery pack that is charged for an hour after the CHARGE lamp goes out.
  - Using Sony “Memory Stick PRO Duo” media (sold separately).

- [Image: Quality] is set to [Fine].
- [Autofocus Mode] is set to [Automatic AF].
- Shooting once every 30 seconds.
- The power turns on and off once every ten times.
- [GPS On/Off] is set to [On].
- About the number of images you can shoot when the flash is used:
  - The flash strobos once every two times.
  - The measurement method is based on the CIPA standard.  
(CIPA: Camera & Imaging Products Association)

# Cleaning

## Cleaning the camera

- Do not touch the inside of the camera, such as lens contacts, or the mirror. Since dust on the mirror or around the mirror may affect the images or the performance of the camera, blow the dust away using a commercially available blower\*. For details on cleaning the image sensor, see the next page.
  - \* Do not use a spray blower. Using one may cause a malfunction.
- Clean the camera surface with a soft cloth slightly moistened with water, then wipe the surface with a dry cloth. Do not use the following as they may damage the finish or the casing.
  - Chemical products such as thinner, benzene, alcohol, disposable cloths, insect repellent, sunscreen or insecticide, etc.
  - Do not touch the camera with the above on your hand.
  - Do not leave the camera in contact with rubber or vinyl for a long time.

## Cleaning the lens

- Do not use a cleaning solution containing organic solvents, such as thinner, or benzene.
- When cleaning the lens surface, remove dust using a commercially available blower. In case of dust that sticks to the surface, wipe it off with a soft cloth or tissue paper slightly moistened with lens cleaning solution. Wipe in a spiral pattern from the center to the outside. Do not spray lens cleaning solution directly onto the lens surface.

## Cleaning the image sensor

If dust or debris enters the camera and lands on the image sensor (the part that acts as the film), it may appear on the photo image, depending on the shooting environment. If there is dust on the image sensor, clean the image sensor following the steps below.

### Notes

- Cleaning cannot be performed when the battery level is 50% or less.
- The camera starts beeping if the battery pack becomes low during cleaning. Stop cleaning immediately and turn the camera off. The use of an AC-PW20 AC Adaptor (sold separately) is recommended.
- The cleaning should be completed quickly.
- Do not use a spray blower because it may scatter water droplets inside the camera body.

To clean the image sensor automatically using the cleaning mode of the camera

**1** Confirm that the battery is fully charged (page 22).

**2** Press the MENU button, then select **2** with **◀/▶** on the control button.

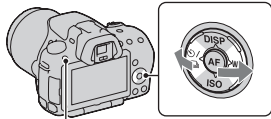

MENU button

**3** Select [Cleaning Mode] with **▲/▼**, then press the center of the control button.

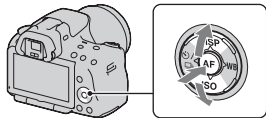



---

#### 4 Select [Enter] with ▲, and press the center of the control button.

The image sensor vibrates for a short time, and eliminates dust from the sensor.

---

#### 5 Turn off the camera.

---

##### To clean the image sensor using a blower

If another cleaning is needed after using the cleaning mode, clean the image sensor using a blower following the steps below.

---

#### 1 Perform the cleaning operation described in steps 1 to 4 of “To clean the image sensor automatically using the cleaning mode of the camera.”

---

#### 2 Detach the lens (page 27).

---

#### 3 Push the ▼ mark on the mirror lock lever to lift up the mirror.

- Be careful not to touch the surface of the mirror.

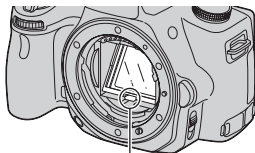

Mirror lock lever

---

#### 4 Use the blower to clean the image sensor surface and the surrounding area.

- Do not touch the image sensor with the tip of the blower and do not put the tip of a blower into the cavity beyond the mount.
- Hold the camera's face downward to prevent the dust from resettling in the camera. Complete the cleaning quickly.
- Also clean the back of the mirror using a blower.

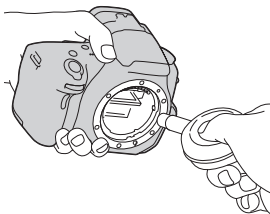

---

#### 5 After the cleaning is finished, lower the mirror with a finger until it clicks.

- Lower the frame of the mirror back down with a finger. Be careful not to touch the surface of the mirror.
- Lower the mirror down until it locks firmly.

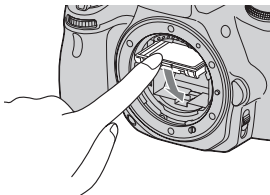

---

#### 6 Attach the lens and turn the camera off.

- Confirm that the mirror is locked down firmly when you attach the lens.

---

#### Notes

- After the cleaning is finished, confirm that the mirror is locked down firmly when you attach the lens. Otherwise, the lens may be scratched or this may be the cause of additional trouble. Also, if the mirror is not locked down firmly, the autofocus does not work during shooting.
- You cannot shoot while the mirror is lifted up.

# Screen indicators

Switching the screen mode between the LCD monitor and the electronic viewfinder

When you look into the viewfinder, the viewfinder mode is activated, and when you take your face away from the viewfinder, the screen mode returns to the LCD monitor mode.

You can also switch the screen mode using the FINDER/LCD button.

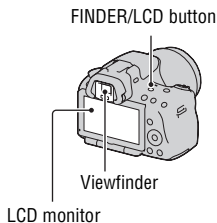

## To focus on a subject quickly using the viewfinder

When you look into the viewfinder, the subject located in the AF area comes into focus automatically (Eye-Start AF).

## MENU button → 1 → [Eye-Start AF] → [On]

When the FDA-A1AM Angle Finder (sold separately) is attached to the camera, setting [Eye-Start AF] to [Off] is recommended because the eyepiece sensors located below the viewfinder may be activated.

## Switching the recording information display (DISP)

Each time you press DISP on the control button, the recording information display changes as follows.

The status of the screen in the viewfinder changes as follows (“Recording information on” (For Live View) is skipped). You can switch the screen in the viewfinder separately from the screen on the LCD monitor.

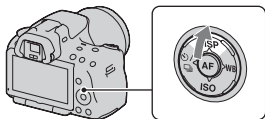

Graphic Display

Recording information on (For Live View)

Recording information off

Digital level gauge on

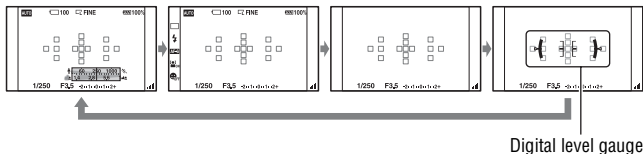

### The digital level gauge of this camera

The digital level gauge indicates whether the camera is level in both the horizontal and front-back directions. When the camera is level in both directions, the indicator turns to green.

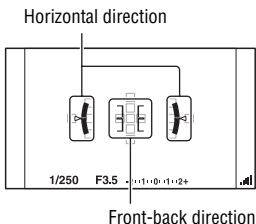

### Notes

- The error of the digital level gauge is larger if you tilt the camera too far forward or backward.
- A tilt of  $\pm 1^\circ$  may be indicated even if the camera is almost level.

## Recording information display (For viewfinder)

You can switch the “Recording information on” display on the LCD monitor to a screen that is suitable for shooting when you look into the viewfinder. The screen in the viewfinder is for Live View.

**MENU button** → **⚙ 2** → **[Display Rec. Data]** → **[For viewfinder]**

Each time you press DISP on the control button, the screen changes as follows.

Graphic Display

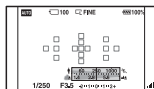

Recording information display (For viewfinder)

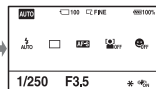

Recording information off

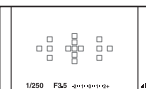

Digital level gauge on

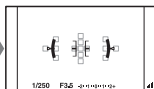

Before your operation

## Recording information display (Graphic Display/Recording information (For Live View))

The Graphic Display graphically shows the shutter speed and aperture value and clearly illustrates how the exposure works.

**Graphic Display**

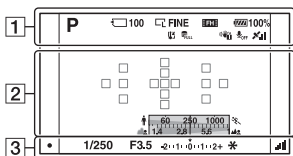

**Recording information display (For Live View)**

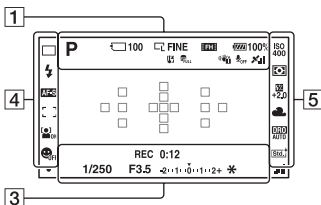





1

| Display  | Indication   |
|--|--|
| AUTO AUTO+<br>P A<br>S M<br>Landscape, Portrait, Macro, Night, Sports, Action, Close-up, Smile, Self-timer, Custom | Exposure mode (59 – 80)<br>• (SLT-A55/A55V)/<br>(SLT-A33)  |
| Memory card icon   | Memory card (20)   |
| 100  | Remaining number of recordable images (32)   |
| M S<br>M S<br>WIDE<br>STD<br>3D 16:9<br>3D STD<br>3D WIDE  | Image size of still images (141)/Aspect ratio of still images (143)/Image size of panoramic images (142) |



| Display                     | Indication   |
|-----------------------------|--|
| RAW<br>RAW+J<br>FINE<br>STD | Image quality of still images (143)                    |
| FH : 1080<br>VGA            | Image size of movies (142)                             |
| 100%                        | Remaining battery (22)                                 |
| Overheating warning icon    | Overheating warning (190)                              |
| FULL ERROR                  | Database file full (190)/<br>Database file error (190) |
| Camera shake warning icon   | Camera shake warning (57)                              |
| Off                         | No audio recording of movies (82)                      |

| Display   | Indication                                     |
|---|--|
|  | GPS triangulating status (138) (SLT-A55V only) |



2





| Display   | Indication                   |
|---|------------------------------|
|  | Spot metering area (105)     |
|  | AF area (89)                 |
|  | Shutter speed indicator (75) |
|  | Aperture indicator (72)      |

3









| Display   | Indication                        |
|---|-----------------------------------|
| <b>REC 0:12</b>   | Recording time of the movie (m:s) |
|  | Focus (86)                        |
| <b>1/250</b>  | Shutter speed (75)                |
| <b>F3.5</b>   | Aperture (72)                     |
| <b>-2 1 0 1 2</b>   | EV scale (78, 119)                |
|  | AE lock (100)                     |
|  | SteadyShot scale (57)             |

4

| Display   | Indication                             |
|---|--|
|  | Drive mode (116)                       |
|  | Flash mode (96)/Red-eye reduction (98) |
| <b>AF-A AF-S</b><br><b>AF-C MF</b>  | Focus mode (88)                        |

| Display   | Indication                 |
|---|----------------------------|
|  | AF area (89)               |
|  | Face Detection (93)        |
|  | Smile Shutter (94)         |
|  | Smile Detection            |
|  | Sensitivity indicator (94) |

5

| Display   | Indication  |
|---|---|
| <b>ISO 400</b>   | ISO sensitivity (106)   |
|                  | Metering (105)  |
|                  | Flash compensation (103)  |
| <b>AWB</b>       | White balance (Auto, Preset, Custom, Color temperature, Color filter) (112) |
| <b>7500K G9</b>   |   |
| <b>D-R</b>       | D-Range Optimizer (107)/Auto HDR (108)                                      |
| <b>HDR</b>       |   |
| <b>Std.</b>      | Creative Style (110)  |
| <b>Port.</b>     |   |
| <b>Sunset</b>  |   |

## Recording information display (For viewfinder)

See pages in parentheses for details of operation.

### In AUTO, AUTO+, or Scene Selection mode

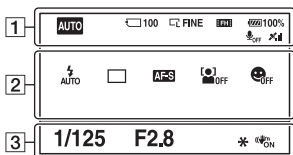

### In Continuous Advance Priority AE/P/A/S/M mode

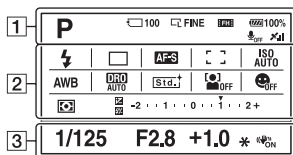

1

| Display   | Indication  |
|---|---|
|   | Exposure mode (59 – 80) <ul style="list-style-type: none"> <li>•  (SLT-A55/A55V)/<br/> (SLT-A33)</li> </ul> |
|   | Memory card (20)  |
| <b>100</b>  | Remaining number of recordable images (32)  |
|   | Image size of still images (141)/Aspect ratio of still images (143)   |
| <b>RAW</b><br><b>RAW+J</b><br><b>FINE</b><br><b>STD</b> | Image quality of still images (143)   |
|   | Image size of movies (142)  |
| <b>100%</b>   | Remaining battery (22)  |
| OFF   | No audio recording of movies (82)   |

| Display | Indication                                     |
|---------|--|
|         | GPS triangulating status (138) (SLT-A55V only) |

2

| Display | Indication                             |
|---------|--|
|         | Flash mode (96)/Red-eye reduction (98) |
|         | Drive mode (116)                       |
|         | Focus mode (88)                        |
|         | Face Detection (93)                    |
|         | Smile Shutter (94)                     |



| Display | Indication  |
|---------|---|
|         | AF area (89)  |
|         | ISO sensitivity (106)   |
|         | White balance (Auto, Preset, Custom, Color temperature, Color filter) (112) |
|         | D-Range Optimizer (107)/Auto HDR (108)                                      |
|         | Creative Style (110)  |
|         | Metering mode (105)   |
|         | Exposure compensation (101)/Metered Manual (78)                             |
|         | Flash compensation (103)  |
|         | EV scale (78, 119)  |

3

| Display      | Indication         |
|--------------|--------------------|
| <b>1/125</b> | Shutter speed (75) |
| <b>F2.8</b>  | Aperture (72)      |
| <b>+1.0</b>  | Exposure (101)     |
| <b>*</b>     | AE lock (100)      |
|              | SteadyShot (57)    |

# Selecting a function/setting

You can select a function for shooting or playback with the one of buttons, such as the Fn (Function) button, or the MENU button.

When you start an operation, an operation guide of control button functions will be displayed at the bottom of the screen.

◀▶: Press ▲/▼/◀/▶ on the control button to move the cursor.

●: Press the center button to execute the selection.

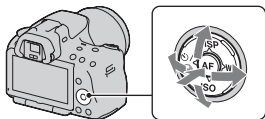

In this Instruction Manual, the process of selecting a function with the control button and the Fn button from the list displayed on the screen is described as follows (we explain the process with the default icons.):

**Example: Fn button → AWB (White Balance) → Select the desired setting**

## The operation guide list

The operation guide also indicates operations other than the control button operation. The indications of icons are as follows.

|  |                          |
|--|--------------------------|
|  | MENU button              |
|  | Returns with MENU button |
|  | 🗑️ (Delete) button       |
|  | ⊕ (Zoom in) button       |
|  | ⊖ (Zoom out) button      |
|  | ▶ (Playback) button      |
|  | Control dial             |

## Help guide

The Help Guide shows the information on a function selected with the Fn button, MENU button, etc. You can also turn it off (page 151).

## Selecting a function with the Fn (Function) button

This button is used for setting up or executing functions used frequently in shooting.

### 1 Press the Fn button.

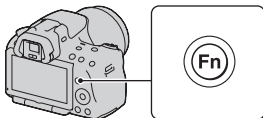

### 2 Select the desired item with ▲/▼/◀/▶ on the control button, then press the center ● to execute.

The setup screen appears.

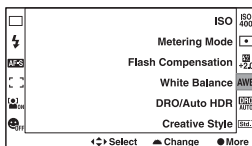

### 3 Following the operation guide, select and execute the desired function.

- For details on how to set up each item, see the corresponding page.

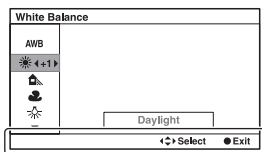

Operation guide

## To set up the camera directly from the recording information screen

Turn the control dial without pressing the center ● in step 2. You can set up the camera directly from the recording information screen.

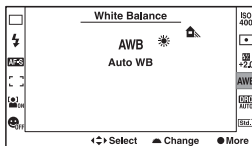

## The functions selected by the Fn (Function) button









|                                 |   |
|---------------------------------|---|
| <b>Scene Selection (63)</b>     | Selects an appropriate mode from among the Scene Selection preset settings to suit shooting conditions.                     |
| <b>Sweep Shooting (66)</b>      | Switches between Sweep Panorama and 3D Sweep Panorama.  |
| <b>Drive Mode (116)</b>         | Sets the shooting mode to single-shot adv., continuous adv., self-timer, bracket shooting, etc.                             |
| <b>Flash Mode (96)</b>          | Sets the flash mode to Autoflash, Fill-flash, Flash Off, etc.   |
| <b>Autofocus Mode (88)</b>      | Selects the method for focusing according to movement of the subject.   |
| <b>AF area (89)</b>             | Selects the area of focus.  |
| <b>Face Detection (93)</b>      | Automatically captures people's face(s) with the optimal focus and exposure.  |
| <b>Smile Shutter (94)</b>       | Camera shoots when a smile is detected.   |
| <b>ISO (106)</b>                | Sets the sensitivity to light. The larger the number, the faster the shutter speed.   |
| <b>Metering Mode (105)</b>      | Selects the method for measuring brightness.  |
| <b>Flash Compensation (103)</b> | Adjusts the intensity of flash output. + direction increases brightness of subject, and the - direction increases darkness. |
| <b>White Balance (112)</b>      | Adjusts the color tone of images.   |
| <b>DRO/Auto HDR (107)</b>       | Compensates for the brightness and contrast automatically.  |
| <b>Creative Style (110)</b>     | Selects your desired image processing.  |

## The functions selected by the MENU button

You can set up the basic settings for the camera as a whole or execute functions such as shooting, playback, or other operations.









Press the MENU button, select the desired page with ◀/▶ on the control button, and select the desired item with ▲/▼.

### Recording menu









|  |  1 | 2 | 3 |  |  |  |  |  |
|--|---|---|---|---|---|---|---|---|
| <br> |    |   |   |   |   |   |   |   |
|  | <b>Image: Size (141)</b>  |   |   |   |   |   |   |   |
|  | <b>Image: Aspect Ratio (143)</b>  |   |   |   |   |   |   |   |
|  | <b>Image: Quality (143)</b>   |   |   |   |   |   |   |   |
|  | <b>Movie: File Format (82)</b>  |   |   |   |   |   |   |   |
|  | <b>Movie: Size (142)</b>  |   |   |   |   |   |   |   |
|  | <b>Movie: Audio Rec. (82)</b>   |   |   |   |   |   |   |   |
| <b>SteadyShot (57)</b>   |   |   |   |   |   |   |   |   |

Before your operation













|  <span style="margin-left: 10px;">1</span> <span style="margin-left: 10px; border: 1px solid black; padding: 0 2px;">2</span> <span style="margin-left: 10px;">3</span> <span style="margin-left: 20px;"></span> <span style="margin-left: 10px;"></span> <span style="margin-left: 10px;"></span> <span style="margin-left: 10px;"></span> <span style="margin-left: 10px;"></span> |                                  |   |
|--|----------------------------------|---|
| <br>   | <b>Panorama: Size (142)</b>      | Selects the size of panoramic images.                                       |
|  | <b>Panorama: Direction (68)</b>  | Sets the shooting direction for panoramic images.                           |
|  | <b>3D Pan.: Image Size (142)</b> | Selects the size of 3D-images.  |
|  | <b>3D Pan.: Direction (68)</b>   | Sets the shooting direction for 3D-images.                                  |
|  | <b>Flash control (104)</b>       | Sets the method for determining the intensity of flash output.              |
|  | <b>AF Illuminator (98)</b>       | Sets the AF illuminator, which sheds light on a dark scene to aid focusing. |
|  | <b>Color Space (111)</b>         | Changes the range of reproducible colors.                                   |











|  <span style="margin-left: 10px;">1</span> <span style="margin-left: 10px; border: 1px solid black; padding: 0 2px;">2</span> <span style="margin-left: 10px;">3</span> <span style="margin-left: 20px;"></span> <span style="margin-left: 10px;"></span> <span style="margin-left: 10px;"></span> <span style="margin-left: 10px;"></span> <span style="margin-left: 10px;"></span> |                               |  |
|--|-------------------------------|--|
| <br>   | <b>Long Exposure NR (149)</b> | Sets noise reduction processing for shots in which shutter speed will be 1 second or longer. |
|  | <b>High ISO NR (149)</b>      | Sets noise reduction processing for high-sensitivity shooting.                               |



## Custom menu

|   <span style="border: 1px solid black; padding: 2px;">1 2</span>     |   |
|---|---|
| <br><br>   | <b>Eye-Start AF (39)</b><br>Sets whether or not to use auto focus when you look through viewfinder.   |
|   | <b>FINDER/LCD Setting (154)</b><br>Sets the method for switching between the viewfinder and LCD monitor.  |
|   | <b>AEL button (150)</b><br>Sets the operation method of the AE lock button for fixing exposure during shooting.   |
|   | <b>Focus Hold Button (150)</b><br>Sets the function of the focus hold button of the lens.   |
|   | <b>Focus Magnifier (150)</b><br>Sets whether or not to assign the  (Delete) button to the functions used with the Focus Magnifier feature. |
|   | <b>Red Eye Reduction (98)</b><br>Reduces the red-eye phenomenon during flash use.   |
|   | <b>Release w/oLens (151)</b><br>Sets whether shutter can open when lens is not attached.  |



|   <span style="border: 1px solid black; padding: 2px;">1 2</span>     |  |
|---|--|
| <br><br>  | <b>Grid Line (154)</b><br>Sets a grid line display to enable alignment to a structural outline.  |
|   | <b>Histogram (102)</b><br>Sets whether or not to include the histogram display when switching screen display.  |
|   | <b>Display Rec. Data (41)</b><br>Selects the status of the recording information display on the LCD monitor, either [For Live View] or [For viewfinder]. |
|   | <b>Auto Review (154)</b><br>Displays the captured image after shooting. Sets auto review.  |
|   | <b>Auto+ Cont. Advance (62)</b><br>Sets whether or not to shoot continuously in AUTO+ mode.  |
|   | <b>Auto+ Image Extract. (62)</b><br>Sets whether or not to save all the images that were shot continuously in AUTO+ mode.                                |



## Playback menu

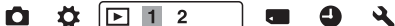

|  |                                 |   |
|--|---------------------------------|---|
|  | <b>Delete (132)</b>             | Deletes images.   |
|  | <b>Still/Movie Select (122)</b> | Switches between the still image playback screen and the movie playback screen. |
|  | <b>Slide Show (125)</b>         | Shows a slide show.   |
|  | <b>Image Index (125)</b>        | Displays the image list.  |
|  | <b>3D Viewing (135)</b>         | Plays back 3D-images using a 3D-compatible TV connected to the camera.          |
|  | <b>Protect (131)</b>            | Protects or cancels protection for an image.                                    |
|  | <b>Specify Printing (172)</b>   | Specifies or unspecifies the images for DPOF.                                   |

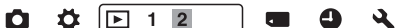

|  |                               |  |
|--|-------------------------------|--|
|  | <b>Volume Settings (122)</b>  | Sets the volume for movie playback.                  |
|  | <b>Select Folder (121)</b>    | Changes the folder for images to play back.          |
|  | <b>Select Date (123)</b>      | Displays images from another date.                   |
|  | <b>Playback Display (121)</b> | Sets how to play back an image recorded in portrait. |





## Memory Card Tool menu



|   |                                 |   |
|---|---------------------------------|---|
|  | <b>Format (146)</b>             | Formats the memory card.  |
|   | <b>File Number (145)</b>        | Sets the method used to assign file numbers to still images and movies.                                       |
|   | <b>Folder Name (145)</b>        | Sets the folder format for still images.  |
|   | <b>Select REC Folder (146)</b>  | Changes the selected folder for storing still images.   |
|   | <b>New Folder (146)</b>         | Creates a new folder for storing still images and movies.   |
|   | <b>Recover Image DB (147)</b>   | Recovers the image database file for movies and enables recording and playback.                               |
|   | <b>Display Card Space (147)</b> | Displays the remaining recording time of movies and the recordable number of still images on the memory card. |



## Clock setup menu



|   |                             |   |
|---|-----------------------------|---|
|  | <b>Date/Time Setup (28)</b> | Sets date and time, and daylight savings. |
|   | <b>Area Setting (29)</b>    | Sets the location of use.                 |



## Setup menu



|  |   |   |
|--|---|---|
|  | <b>LCD Brightness (153)</b>               | Sets the brightness of the LCD monitor.   |
|  | <b>Viewfinder Bright. (153)</b>           | Sets the brightness of the viewfinder.  |
|  | <b>GPS Settings (138) (SLT-A55V only)</b> | Sets the GPS functions.   |
|  | <b>Power Save (151)</b>                   | Sets the interval after which power save mode engages.                                  |
|  | <b>CTRL FOR HDMI (136)</b>                | Operates the camera from a TV that support "BRAVIA" Sync.                               |
|  | <b>Language (152)</b>                     | Selects the language.   |
|  | <b>Help Guide Display (151)</b>           | Sets the display of the help guide for explaining functions displayed during operation. |



|  |                               |  |
|--|-------------------------------|--|
|  | <b>Upload Settings (147)*</b> | Sets the upload function of the camera when using an Eye-Fi card.                                  |
|  | <b>USB Connection (165)</b>   | Sets the USB connection method.  |
|  | <b>Audio signals (151)</b>    | Sets whether or not to use the beep sound when the focus is achieved or the self-timer is working. |
|  | <b>Cleaning Mode (36)</b>     | Starts the cleaning mode to clean the image sensor.  |
|  | <b>Version (155)</b>          | Displays the camera software version.  |
|  | <b>Demo Mode (152)</b>        | Sets the demonstration playback of a movie to on or off.   |
|  | <b>Reset Default (156)</b>    | Restores the settings to their defaults.   |

\* Appears when an Eye-Fi card (sold separately) is inserted in the camera.

# Adjusting the angle of the LCD monitor

You can adjust the angle of the LCD monitor to meet various shooting situations.

You can shoot from various shooting positions.



Low position



High position

## Adjust the LCD monitor to an easily viewable angle.

- The LCD monitor tilts 180 degrees.
- The LCD monitor can be rotated leftward 270 degrees from the position in which the LCD monitor is facing forward as illustrated.
- When the LCD monitor is not used, it is recommended that you close it with the screen side facing to the camera.

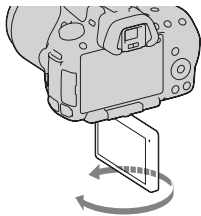
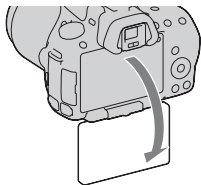

# Shooting an image without camera shake

“Camera shake” refers to unwanted movement of the camera that occurs after the shutter button has been pressed, resulting in a blurred image. To reduce camera shake, follow the instructions below.

## Correct posture

**Stabilize your upper body and take a position that keeps the camera from moving.**

In LCD monitor mode

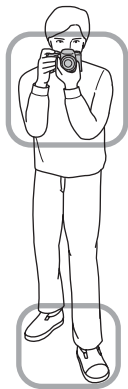

In viewfinder mode

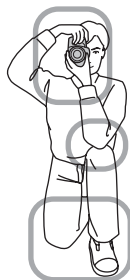

Point ①

One hand holds the grip of the camera, and the other hand supports the lens.

Point ②

Take a secure stance with your feet shoulder-width apart.

### Point ③

Lightly tuck your elbows against your body.

When shooting in a kneeling position, steady your upper body by placing your elbow on your knee.

### Camera shake warning indicator

Due to potential camera shake, the  (Camera shake warning) indicator flashes. In this case, use a tripod or the flash.

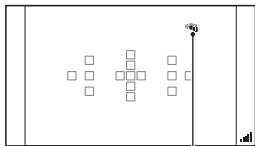

 (Camera shake warning) indicator

### Note

- The  (Camera shake warning) indicator is displayed only in the modes that automatically set the shutter speed. This indicator is not displayed in M/S modes.

## Using the SteadyShot function

The SteadyShot function can reduce the effect of camera shake by the equivalent of approximately 2.5 to 4 Ev in shutter speed.

The SteadyShot function is set to [On] in the default setting.

### The SteadyShot scale indicator

The  (SteadyShot scale) indicator shows the camera shake status. Wait until the scale becomes low, then start shooting.

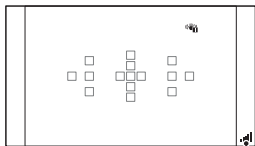

 (SteadyShot scale) indicator

### To deactivate the SteadyShot function

**MENU button** →  **1** → [SteadyShot] → [Off]

**Note**

- The SteadyShot function may not work optimally when the power has just been turned on, right after you point the camera towards a subject, or when the shutter button has been pressed all the way down without stopping halfway.

## Using a tripod

In the following cases, we recommend that you mount the camera on a tripod.

- Shooting without a flash under dark conditions.
- Shooting with slow shutter speeds, which are typically used in night-time shooting.
- Shooting a close subject, such as in macro shooting.
- Shooting with a telescopic lens.

**Note**

- When using a tripod, deactivate the SteadyShot function because there is a potential for malfunction of the SteadyShot function.

# Shooting with the automatic setting

**AUTO** /  Shooting with appropriate settings automatically

The “AUTO” mode allows you to easily shoot any subject under any conditions because the camera makes appropriate judgments on the situation to adjust the settings.

Select  when shooting in a location where the use of a flash is restricted.

**1** Set the mode dial to **AUTO** or  (Flash Off).

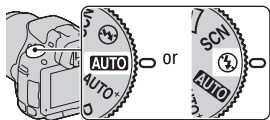

**2** Adjust the LCD monitor to an easily viewable angle and hold the camera.

**3** Overlay the AF area on the desired subject.

- If the  (Camera shake warning) indicator flashes, carefully shoot the subject, holding the camera steady, or by using a tripod.

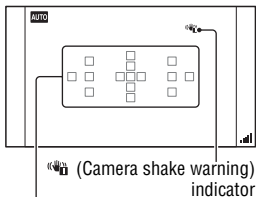

AF area

 (Camera shake warning) indicator

**4** When using a zoom lens, turn the zoom ring, then decide on your shot.

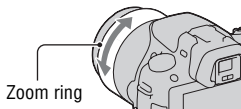

Zoom ring

---

## 5 Press the shutter button halfway down to focus.

When the focus is confirmed, ● or (Focus indicator) lights up (page 86).

- Waiting until the (SteadyShot scale) indicator is low makes the SteadyShot function more effective.

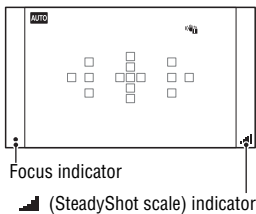
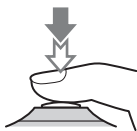

---

## 6 Press the shutter button fully down to shoot.

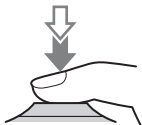

---

### Note

- Since the camera turns on the automatic setting function, many features will be unavailable, such as exposure compensation, ISO setting. If you want to adjust various settings, set the mode dial to P, then shoot your subject.



## AUTO+ Shooting with the settings that the camera adjusts automatically

The camera recognizes and evaluates the shooting condition, and appropriate settings are set automatically. The camera saves one appropriate image by combining or separating images, as necessary.

### 1 Set the mode dial to AUTO+ (Auto+).

### 2 Point the camera towards the subject.

When the camera recognizes and adjusts for shooting conditions, the following information is indicated: recognized scene mode mark, appropriate shooting function, the number of images to be shot.

Recognized scene mode mark

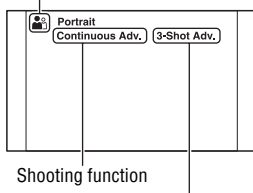









Shooting function

Number of images to be shot

### 3 Adjust the focus and shoot the subject.

The camera shoots with the automatically selected settings.

#### Scene recognized by the camera

|  |  |   |
|--|--|---|
|  (Night View)           |  (Hand-held Twilight) |  (Landscape)           |
|  (Backlight Portrait) |  (Portrait)         |  (Tripod Night View) |
|  (Backlight)          |  (Macro)            |  (Night Portrait)    |

#### Shooting function

|                       |                 |                |
|-----------------------|-----------------|----------------|
| Continuous adv. (116) | Slow Sync. (96) | Auto HDR (108) |
| Daylight Sync.        | Slow Shutter    |                |

## To set the continuous shooting

**MENU button** → **⚙ 2** → **[Auto+ Cont. Advance]** → **Select the desired setting**

## To select the storage method to be used for recorded images

In continuous shooting, you can select a storage method that allows the camera either to store one appropriate image from among the continuously shot images or store all the images.

**MENU button** → **⚙ 2** → **[Auto+ Image Extract.]** → **Select the desired setting**

### Notes

- Even when you set [Auto+ Image Extract.] to [Off] with [Hand-held Twilight] selected from recognized scene mode, one combined image is saved.
- The numbers of images that were not saved are skipped when the images are extracted.

# Shooting with a suitable setting for the subject

Selecting an appropriate mode for the subject or the shooting conditions allows you to shoot the image with a suitable setting for the subject. When you turn the mode dial, the explanation of the selected mode and methods of shooting are displayed on the screen (Help Guide Display).

## SCN Shooting with preset settings according to the scene (Scene Selection)

### This mode is suitable for

- Shooting with preset settings according to the scene



---

**1** Set the mode dial to SCN (Scene Selection).













---





**2** Press the center of the control button.

---

**3** Select the desired mode with ▲/▼, then press the center of the control button.

- To change the scene, press the Fn button, then select another scene.
-

|  |  |   |
|--|--|---|
|  (Portrait)       | <p>Blurs away backgrounds and sharpens the subject. Expresses skin tones softly.</p> <ul style="list-style-type: none"> <li>• To blur the background more, set the lens to the telephoto position.</li> <li>• You can shoot a vivid image by focusing on the eye that is closer to the lens.</li> <li>• Use the lens hood (sold separately) to shoot backlit subjects.</li> <li>• Use the red-eye reduction function if the eyes of your subject turn red from the flash (page 98).</li> </ul> |     |
|  (Sports Action) | <p>Shoots a moving subject at a fast shutter speed so that the subject looks as if it is standing still. The camera shoots images continuously while the shutter button is pressed.</p> <ul style="list-style-type: none"> <li>• Press and hold the shutter button halfway down until the right moment.</li> </ul>   |    |
|  (Macro)         | <p>Shoots close subjects such as flowers, foods.</p> <ul style="list-style-type: none"> <li>• You can shoot a closer subject using a macro lens (sold separately).</li> <li>• Set the flash mode to [Flash Off] when you shoot a subject within 1 m (3.3 feet).</li> <li>• When shooting in macro mode, the SteadyShot function will not be fully effective. Use a tripod to achieve better results.</li> <li>• The shortest focal distance does not change.</li> </ul>                        |    |
|  (Landscape)     | <p>Shoots the entire range of scenery in sharp focus with vivid colors.</p> <ul style="list-style-type: none"> <li>• To accentuate the openness of the scenery, set the lens to wide angle.</li> </ul>   |    |
|  (Sunset)      | <p>Shoots the red of the sunrise or sunset beautifully.</p>  |  |
|  (Night View)  | <p>Shoots night scenes at a distance without losing the dark atmosphere of the surroundings.</p> <ul style="list-style-type: none"> <li>• The shutter speed is slower, so using a tripod is recommended.</li> <li>• The picture may not be taken properly when shooting a wholly dark night scene.</li> </ul>  |  |

|  |   |   |
|--|---|---|
| <p> (Hand-held Twilight)</p> | <p>Shoots night scenes with less noise and blur without using a tripod. A burst of shots are taken, and image processing is applied to reduce subject blur, camera shake, and noise.</p> <ul style="list-style-type: none"> <li>• Reducing blur is less effective even in [Hand-held Twilight] when shooting:           <ul style="list-style-type: none"> <li>– Subjects with erratic movement</li> <li>– Subjects are too close to the camera</li> <li>– Subjects with a repeating pattern such as tiles, and subjects with little contrast such as sky, sandy beach, or lawn</li> <li>– Subjects with constant change such as waves or water falls</li> </ul> </li> <li>• In the case of [Hand-held Twilight], block noise may occur when using a light source that flickers, such as fluorescent lighting.</li> </ul> |   |
| <p> (Night Portrait)</p>    | <p>Shoots portraits in night scenes.</p> <ul style="list-style-type: none"> <li>• The shutter speed is slower, so using a tripod is recommended.</li> </ul>   |  |

### Shooting technique

- When you want finer images, set the mode dial to P, A, S, or M and use the creative style function (page 110). In such cases, you can adjust the exposure, ISO, etc.

### Notes

- Since the camera judges the settings automatically, many features will be unavailable, such as exposure compensation, ISO setting.
- The flash is set to [Autoflash] or [Flash Off] for each Scene Selection mode. You can change these settings (page 96).

## Shooting panoramic images (Sweep Shooting)

### This mode is suitable for

- Shooting expansive scenery, or high-rise buildings with dynamic composition.



**1** Set the mode dial to  (Sweep Shooting).

**2** Press the center of the control button.

**3** Select [Sweep Panorama] with ▲/▼, then press the center of the control button.

- To select [3D Sweep Panorama], press the Fn button, then select it.

**4** Point the camera at the edge of the subject, then press the shutter button halfway down to adjust the focus.

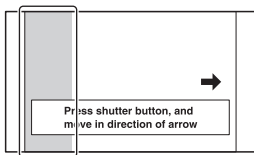

This part will not be taken

**5** Press the shutter button fully down.

## 6 Pan or tilt the camera to the end, following the guidance on the screen.

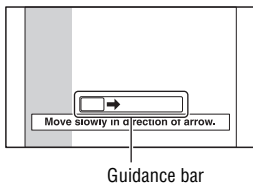

### Notes

- If you cannot pan or tilt the camera across the entire subject within the given time, a gray area occurs in the composed image. If this happens, move the camera fast to record a full panoramic image.
- Since several images are stitched together, the stitched part will not be recorded smoothly. While shooting, do not tilt the camera back and forth, or right and left when you swing the camera straight ahead.
- Under low light conditions, panoramic images may be blurred or not be recorded.
- Under lights that flicker such as fluorescent light, the brightness or color of the combined image is not always the same.
- When the whole angle of panoramic shooting and the angle in which you fixed the focus and exposure with AE/AF lock are extremely different in brightness, color and focus, the shooting will not be successful. If this happens, change the lock angle and shoot again.
- [Sweep Panorama] is not suitable when shooting:
  - Subjects are moving.
  - Subjects are too close to the camera.
  - Subjects with a repeating pattern such as tiles, and subjects with little contrast such as sky, sandy beach, or lawn.
  - Subjects with constant change such as waves or water falls.
  - Subjects with the sun or electric lights, etc. that are much brighter than surroundings.
- [Sweep Panorama] recording may be discontinued in the following situations:
  - You pan or tilt the camera too fast or too slow.
  - There is too much camera shake.
- The camera continues shooting during [Sweep Panorama] recording, and the shutter keeps clicking until the end of the shooting.

## Tips for shooting a panoramic image

Pan or tilt the camera in an arc with a constant velocity and in the same direction as the indication on the screen. [Sweep Panorama] is better suited for still subjects, rather than moving ones.

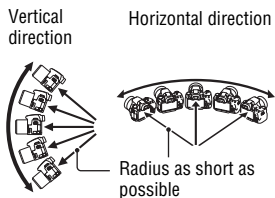

- In Sweep Panorama, it is recommended that you use a wide-angle lens.
- When you use a lens that has a long focal length, pan or tilt the camera more slowly than when you use a wide-angle lens.
- Determine the scene and press the shutter button halfway, so that you can lock the focus, exposure, and white balance.
- If a section with greatly varied shapes or scenery is concentrated along a screen edge, the image composition may fail. In such case, adjust the frame composition so that the section is in the center of the image, then shoot again.
- You can select the image size: MENU button → 2 → [Panorama: Size].

## To create 3D-images

Set the mode dial to (Sweep Shooting), select [3D Sweep Panorama], and shoot the image. Using the same operation as that for Sweep Panorama, the camera records multiple images and combines them to create a 3D-image. You can view these 3D images using a 3D-compatible TV. For details on 3D-shooting, see page 198.

## To set the pan or tilt direction

You can set the direction in which to pan or tilt the camera.

**MENU button → 2 → [Panorama: Direction] or [3D Pan.: Direction] → Select the desired setting**



## / Shooting continuously at high speed (Continuous Advance Priority AE)

### This mode is suitable for

- Shooting a fast-moving subject continuously to capture a moment.
- Shooting a child's expressions, changing continuously from moment to moment.



## 1 Set the mode dial to (SLT-A55/A55V) or (SLT-A33) (Cont. Priority AE).

## 2 Adjust the focus and shoot the subjects.

- The camera continues to shoot while the shutter button is pressed fully down.
- The camera records the images continuously at a maximum of about 10 images per second (SLT-A55/A55V) or at a maximum of about 7 images per second (SLT-A33).

### Shooting techniques

- When the autofocus mode is set to [Continuous AF], the focus and the exposure continue to be adjusted during shooting.
- In manual focus mode or when the autofocus mode is set to [Single-shot AF], you can adjust the ISO sensitivity and the aperture. When [Single-shot AF] is selected, the focus is fixed at the first image.

### Notes

- The Face Detection function is turned off.
- When [Auto HDR] is selected, the DRO process is performed temporarily according to the DRO setting.
- Our measurement conditions. The speed of continuous shooting is slower, depending on shooting conditions.

# Shooting an image the way you want it (Exposure mode)

With an Interchangeable Lens Digital Camera, you can adjust the shutter speed (how long the shutter is open) and aperture (the range that is in focus: depth of field) to enjoy a variety of photographic expressions.

Adjusting the shutter speed and aperture not only creates the photographic effects of movement and focus, but also determines the brightness of the image by controlling the amount of exposure (the amount of light the camera takes in), which is the most important factor in photo shooting.

## Changing the brightness of the picture by the amount of exposure



When using a faster shutter speed, the camera opens the shutter for a shorter time. This means less time for the camera to take in light, resulting in a darker picture. To take a brighter picture, you can open the aperture (the hole through which the light passes) to some extent in order to adjust the amount of light the camera takes in at one time.

The brightness of the picture adjusted by the shutter speed and aperture is called “exposure.”

This section will show you how to adjust the exposure and enjoy various photo expressions by the use of movement, focus, and light.

## P Shooting with program auto

### This mode is suitable for

- Using the automatic exposure, while keeping the custom settings for ISO sensitivity, Creative Style, D-Range optimizer, etc.



---

**1 Set the mode dial to P.**

---

**2 Set the shooting functions to your desired settings (pages 85 to 120).**

- To fire the flash, press the **⚡** button.

---

**3 Adjust the focus and shoot the subject.**

---

## A Shooting by controlling the blur of the background (Aperture priority)

### **This mode is suitable for**

- Putting the subject in sharp focus and blur everything in front of and beyond the subject. Opening the aperture narrows the range that is in focus. (Depth of field becomes shallower.)
- Shooting the depth of the scenery. Narrowing down the aperture widens the range that is in focus. (Depth of field becomes deeper.)



---

### **1 Set the mode dial to A.**

## 2 Select the aperture value (F-number) with the control dial.

- Smaller F-number: The foreground and background of the subject are blurred.  
Larger F-number: The subject and its foreground and background are all in focus.
- You cannot check the blurring of an image on the LCD monitor or in the viewfinder. Check the recorded image and adjust the aperture.

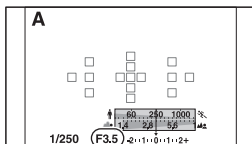
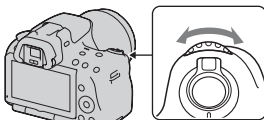

Aperture (F-number)

## 3 Adjust the focus and shoot the subject.

The shutter speed is automatically adjusted to obtain correct exposure.

- When the camera judges that the proper exposure is not obtained with the selected aperture value, the shutter speed flashes. In such cases, adjust the aperture again.

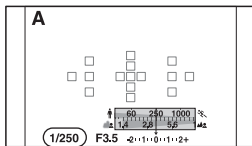

Shutter speed

### Shooting techniques

- The shutter speed may become slower depending on the aperture value. When the shutter speed is slower, use a tripod.
- To blur the background more, use a telephoto lens or a lens that is equipped with a smaller aperture value (bright lens).
- You can check the approximate blurring of the image before recording using the preview button.

### Note

- Press the  button when you shoot with the flash. However, the flash range differs according to the aperture value. When you shoot with the flash, check the flash range (page 98).

### **To check blurring of the background (Preview button)**

The LCD monitor and the viewfinder shows an image captured with the widest aperture. The change in aperture affects the sharpness of the subject image, creating a discrepancy between the sharpness of the image before shooting and that of the actual image.

While you are pressing the preview button, you can see the image with the aperture used in the actual shot so that you can check the approximate sharpness of the subject before shooting.

- Press the preview button after you adjust the focus.
- You can adjust the aperture in preview mode.

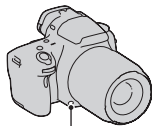

Preview button

## S Shooting a moving subject with various expressions (Shutter speed priority)

### This mode is suitable for

- Shooting a moving subject at a moment in time. Use a faster shutter speed to crisply shoot an instant of the movement.
- Tracing the movement to express the dynamism and flow. Use a slower shutter speed to shoot a trailing image of the moving subject.



### 1 Set the mode dial to S.

## 2 Select the shutter speed with the control dial.

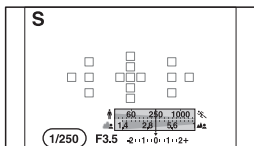
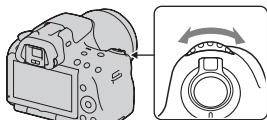

Shutter speed

## 3 Adjust the focus and shoot the subject.

The aperture is automatically adjusted to obtain correct exposure.

- When the camera judges that the proper exposure is not obtained with the selected shutter speed, the aperture value flashes. In such cases, adjust the shutter speed again.

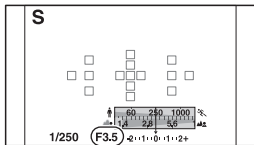



Aperture (F-number)

### Shooting techniques

- When the shutter speed is slower, use a tripod.
- When shooting an indoor sport, select a higher ISO sensitivity.

### Notes

- The  (Camera shake warning) indicator is not indicated in shutter speed priority mode.
- The higher the ISO sensitivity, the more conspicuous the noise.
- When the shutter speed is one second or more, noise reduction (Long Exposure NR) will be done after shooting. You cannot do any further shooting during the reduction.
- Press the  button when you shoot with the flash. However, when using the flash, if you close the aperture (a larger F-number) by making the shutter speed slower, the light of the flash will not reach distant subjects.



## M Shooting with the exposure adjusted manually (Manual exposure)

### This mode is suitable for

- Shooting with the desired exposure setting by adjusting both the shutter speed and aperture.

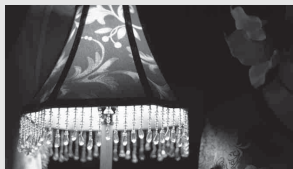

### 1 Set the mode dial to M.

### 2 Rotate the control dial to adjust the shutter speed, and while pressing the button, rotate the control dial to adjust the aperture.

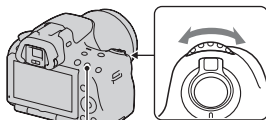

 button

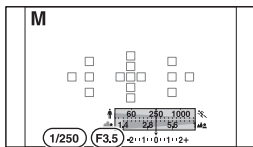

Shutter speed



Aperture (F-number)

### 3 Shoot the image after the exposure is set.

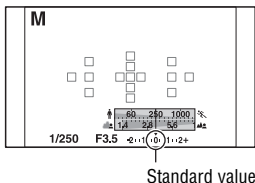
- Check the exposure value on the EV scale (Metered Manual\*).  
Toward +: Images become brighter.  
Toward -: Images become darker.  
The ◀ ▶ arrow appears if the set exposure is beyond the range of the EV scale. The arrow starts flashing if the difference becomes greater.
- \* When the camera is in M mode, it will show an under or over compensation value based on the correct exposure using the index on the exposure compensation indicator.



#### Notes

- The  (Camera shake warning) indicator is not indicated in manual exposure mode.
- When the mode dial is set to M, the ISO setting [AUTO] is set to [100]. In M mode, the ISO setting [AUTO] is not available. Set the ISO sensitivity as necessary (page 106).
- Press the  button when you shoot with the flash. However, the flash range differs according to the aperture value. When you shoot with the flash, check the flash range (page 98).

#### Manual shift

You can change the shutter speed and aperture value combination without changing the exposure you set.

Rotate the control dial while pressing the AEL button to select the shutter speed and aperture value combination.

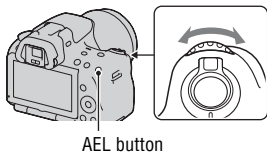

## M Shooting trails with long exposure (BULB)

### This mode is suitable for

- Shooting trails of light, such as fireworks.
- Shooting trails of stars.



### 1 Set the mode dial to M.

### 2 Rotate the control dial to the left until [BULB] is indicated.

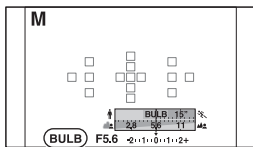
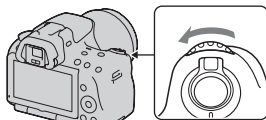

BULB

### 3 While pressing the button, rotate the control dial to adjust the aperture (F-number).

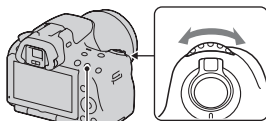

 button

---

## 4 Press the shutter button halfway down to adjust the focus.

---

## 5 Press and hold the shutter button for the duration of the shooting.

As long as the shutter button is pressed, the shutter remains open.

---

### Shooting techniques

- Use a tripod.
- Set the focus to infinity in manual focus mode when shooting fireworks, etc. When the infinity position of the lens is not known, first adjust the focus on fireworks that is set off in the same general area, then shoot them.
- Use the Wireless Remote Commander (sold separately) (page 120). Pressing the SHUTTER button on the Wireless Remote Commander triggers BULB shooting and pressing it again stops BULB shooting. You do not need to press and hold the SHUTTER button on the Wireless Remote Commander.
- If you use a Remote Commander that is equipped with a shutter button lock function (sold separately), you can leave the shutter open using the Remote Commander.

### Notes

- When using a tripod, turn off the SteadyShot function (page 57).
- The longer the exposure time, the more conspicuous the noise on the image.
- After shooting, noise reduction (Long Exposure NR) will be done for the same amount of time that the shutter was open. You cannot do any further shooting during the reduction.
- When the Smile Shutter or Auto HDR function is activated, you cannot set the shutter speed to [BULB].
- If the Smile Shutter or Auto HDR function is used with the shutter speed set to [BULB], the shutter speed is temporarily set to 30 seconds.
- It is recommended that you start BULB shooting after the temperature of the camera drops to prevent the quality of the image from deteriorating.

# Recording movies

## 1 Press the MOVIE button to start recording.

- Movie recording can be started from any exposure mode.
- The shutter speed and aperture are adjusted automatically.
- The camera continues to adjust the focus when it is in autofocus mode.

MOVIE button

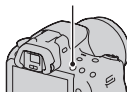

## 2 Press the MOVIE button again to stop recording.

### Shooting techniques

- The following settings that were set during still image shooting are used without change.
  - White Balance
  - Creative Style
  - Exposure compensation
  - AF area
  - Metering mode
- Exposure compensation can be used during movie recording.
- Start recording after you adjust the focus.
- When [AF area] is set to [Local], you can change the AF area during shooting.
- If you want to adjust the blurring of the background, set the mode dial to “A” and set the camera to the manual focus mode. You can adjust the aperture using the control dial before shooting.

### Notes

- The angle of view of movies is narrower than that of still images. After you press the MOVIE button, the camera shows the actual range to be recorded (SLT-A33 only).
- The Face Detection function cannot be used.
- When [Display Rec. Data] is set to [For viewfinder], the LCD monitor is switched to the recording information display at the moment movie recording starts.

- Do not shoot a strong light source, such as the sun. The internal mechanism of the camera may be damaged.
- When you import AVCHD movies to a computer, use “PMB” (page 165).
- When you continue to shoot for a long time, the temperature of the camera rises and the image quality may deteriorate.
- When the [H] mark is indicated, the temperature of the camera is too high. Turn the camera off and wait until the temperature of the camera drops. If you continue to shoot, the camera is turned off automatically.
- In bright conditions, if you use the autofocus, the image motion may not be smooth (high speed shutter). In such a case, the manual focus mode is recommended.
- When you are recording a movie, the aperture cannot be adjusted.

## To change the movie file format

**MENU button** →  **1** → **[Movie: File Format]** → **Select the desired format**

|              |   |
|--------------|---|
| <b>AVCHD</b> | <p>This file format is suitable for viewing smooth video images on a high-definition TV.</p> <p>Movies shot with this camera are recorded in AVCHD format, approximately 60 fields/sec (1080 60i-compatible devices) or 50 fields/sec (1080 50i-compatible devices), in interlace mode, with Dolby Digital audio, AVCHD format.</p> <ul style="list-style-type: none"> <li>• To check if your camera is a 1080 60i-compatible device or 1080 50i-compatible device, check for the following marks on the bottom of the camera.<br/>1080 60i-compatible device: 60i<br/>1080 50i-compatible device: 50i</li> </ul> |
| <b>MP4</b>   | <p>This file format is suitable for WEB uploads, e-mail attachments or playing back on computers.</p> <p>Movies shot with this camera are recorded in MPEG-4 format at approximately 30 frames/sec (1080 60i-compatible devices) or approximately 25 frames/sec (1080 50i-compatible devices), in progressive mode, with AAC audio, mp4 format.</p>   |

## Audio recording

When you record movies, the operating noise of the camera or lens may be recorded. You can reduce the noise of the camera by using a tripod, and setting the SteadyShot function to off.

You can also record movies without audio.

**MENU button** →  **1** → [Movie: Audio Rec.] → [Off]

To change the size

**MENU button** →  **1** → [Movie: Size] → Select the desired size

For details, see page 142.

## Available recording time for a movie

The table below shows the approximate total recording times using a memory card formatted with this camera.

### “Memory Stick PRO Duo”

#### SLT-A55/A55V

(Units: hour : minute : second)

| File format/<br>Size | Capacity |         |         |          |          |
|----------------------|----------|---------|---------|----------|----------|
|                      | 2GB      | 4GB     | 8GB     | 16GB     | 32GB     |
| AVCHD 1920 × 1080    | 0:14:00  | 0:28:30 | 0:58:10 | 1:58:50  | 3:55:20  |
| MP4 1440 × 1080      | 0:20:40  | 0:41:40 | 1:24:40 | 2:52:30  | 5:41:00  |
| MP4 VGA              | 1:15:10  | 2:31:10 | 5:06:20 | 10:23:50 | 20:33:00 |

#### SLT-A33

(Units: hour : minute : second)

| File format/<br>Size | Capacity |         |         |          |          |
|----------------------|----------|---------|---------|----------|----------|
|                      | 2GB      | 4GB     | 8GB     | 16GB     | 32GB     |
| AVCHD 1920 × 1080    | 0:14:00  | 0:28:30 | 0:58:10 | 1:58:50  | 3:55:20  |
| MP4 1440 × 1080      | 0:20:40  | 0:41:40 | 1:24:40 | 2:52:30  | 5:41:00  |
| MP4 VGA              | 1:15:10  | 2:31:10 | 5:06:20 | 10:23:50 | 20:33:00 |

### Notes

- The values shown are not the continuous recording time.
- Recording time may depend on shooting conditions and the memory card used.
- When [L] is indicated, stop recording the movie. The temperature inside the camera has increased to an unacceptable level.
- For details on movie playback, see page 122.

## Notes on continuous movie recording

- It requires a lot of power to perform high quality movie recording or continuous shooting using the APS-C size image sensor. Therefore, if you continue to shoot, the temperature inside the camera will rise, especially that of the image sensor. In such cases, the camera is turned off automatically since higher temperatures affect the quality of the images or burden the internal mechanism of the camera.
- The duration of time available for movie recording is as follows when the camera starts recording after the power of the camera has been turned off for a while. (The following values indicate the continuous time from when the camera starts recording until the camera stops recording.) If you disable the SteadyShot function during movie recording, the recording time is longer.

|                      | Ambient temperature | SteadyShot       |                  |
|----------------------|---------------------|------------------|------------------|
|                      |                     | [On]             | [Off]            |
| SLT-A55/<br>SLT-A55V | 20°C (68°F)         | About 9 minutes  | About 29 minutes |
|                      | 30°C (86°F)         | About 6 minutes  | About 13 minutes |
|                      | 40°C (104°F)        | About 3 minutes  | About 5 minutes  |
| SLT-A33              | 20°C (68°F)         | About 11 minutes | About 29 minutes |
|                      | 30°C (86°F)         | About 7 minutes  | About 22 minutes |
|                      | 40°C (104°F)        | About 4 minutes  | About 9 minutes  |

- The duration of time available for movie recording varies with the temperature or condition of the camera before you start recording. If you frequently recompose or shoot images after the power is turned on, the temperature inside the camera rises and the recording time available is shorter than the values indicated in the table above.
- If the camera stops recording due to the temperature, leave it for several minutes with the power turned off. Start recording after the temperature inside the camera drops fully. (When the camera is left for 5 to 10 minutes at a room temperature of 30°C (86°F), recording will be possible for about 3 to 4 minutes.)
- If you observe the following points, the recording time is longer.
  - Keep the camera out of direct sunlight.
  - Turn the camera off when it is not being used.
  - If possible, use a tripod and disable the SteadyShot function.
- The maximum size of a movie file is about 2 GB. When the file size is about 2 GB, the recording stops automatically when the file format is MP4, and a new movie file is created automatically when the file format is AVCHD.
- The maximum continuous recording time is 29 minutes.



# Selecting the focus method

There are two methods for adjusting the focus: autofocus and manual focus. Depending on the lens, the method for switching between the auto focus and manual focus is different.

| The type of lens                                  | The switch to be used  | To switch to auto focus                        | To switch to manual focus                      |
|---|--|--|--|
| The lens is equipped with a focus mode switch     | Lens (Always set the focus mode switch on the camera to AF.) | Set the focus mode switch on the lens to AF.   | Set the focus mode switch on the lens to MF.   |
| The lens is not equipped with a focus mode switch | Camera   | Set the focus mode switch on the camera to AF. | Set the focus mode switch on the camera to MF. |

## Using autofocus

- 1 Set the focus mode switch on the camera to AF.**

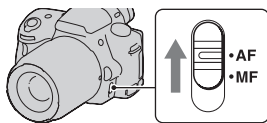

- 2 When the lens is equipped with the focus mode switch, set it to AF.**

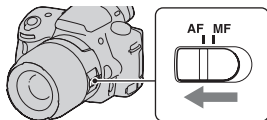

### 3 Press the shutter button halfway down to check the focus and shoot the image.

- When the focus is confirmed, the focus indicator changes to ● or (●) (below).
- The AF area where the focus has been confirmed turns green.

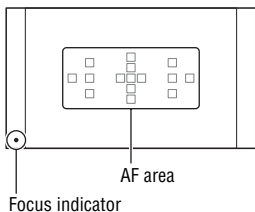

#### Shooting technique

- To select the AF area used for focusing, set up [AF area] (page 89).

#### Focus indicator

| Focus indicator | Status  |
|-----------------|---|
| ● lit           | Focus locked. Ready to shoot.   |
| (●) lit         | Focus is confirmed. Focal point moves following a moving subject. Ready to shoot. |
| (C) lit         | Still focusing. You cannot release the shutter.                                   |
| ● flashing      | Cannot focus. The shutter is locked.  |

#### Subjects that may require special focusing

Using the autofocus, it is hard to focus on the following subjects. In such cases, use the focus lock shooting feature (page 87) or manual focus (page 90).

- A subject that is low in contrast, such as blue sky or a white wall.
- Two subjects at different distances overlapping in the AF area.
- A subject that is composed of repeating patterns, such as the facade of a building.
- A subject that is very bright or glittering, such as the sun, the body of an automobile, or the surface of water.
- Ambient light is not sufficient.

## To measure the exact distance to the subject

The  $\ominus$  mark located on the top of the camera shows the location of the image sensor\*. When you measure the exact distance between the camera and the subject, refer to the position of the horizontal line.

\* The image sensor is the part of the camera that acts as the film.

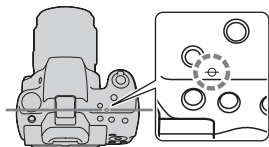

### Note

- If the subject is closer than the minimum shooting distance of the attached lens, the focus cannot be confirmed. Make sure you put enough distance between the subject and the camera.

## Shooting with your desired composition (Focus-lock)

### 1 Place the subject within the AF area and press the shutter button halfway down.

The focus and exposure are fixed.



### 2 Keep the shutter button halfway down, and put the subject back in the original position to re-compose the shot.



### 3 Press the shutter button fully down to take the picture.

## Selecting the focus method to suit the movement of the subject (Autofocus Mode)

**Fn button → AF-A (Autofocus Mode) → Select the desired setting**

|                              |   |
|------------------------------|---|
| <b>AF-S (Single-shot AF)</b> | The camera focuses and the focus is locked when you press the shutter button halfway down.  |
| <b>AF-A (Automatic AF)</b>   | The [Autofocus Mode] is switched between Single-shot AF and Continuous AF according to the movement of the subject.<br>When you press and hold the shutter button halfway down, if the subject is motionless, the focus is locked and if the subject is in motion, the camera continues to focus. |
| <b>AF-C (Continuous AF)</b>  | The camera continues to focus while the shutter button is pressed and held halfway down. <ul style="list-style-type: none"><li>• The audio signals will not sound when the subject is in focus.</li><li>• Focus-lock cannot be used.</li></ul>  |

### Shooting techniques

- Use [Single-shot AF] when the subject is motionless.
- Use [Continuous AF] when the subject is in motion.

### Notes

- [Automatic AF] is selected when the exposure mode is set to AUTO, AUTO+ or one of the following Scene Selection modes: [Portrait], [Landscape], [Sunset], [Night View], [Night Portrait], or [Hand-held Twilight].  
[Single-shot AF] is selected when the exposure mode is set to [Macro] in Scene Selection.  
[Continuous AF] is selected when the exposure mode is set to [Sports Action] in Scene Selection.
- [Continuous AF] is selected when the Smile Shutter function is used.

## Selecting the focus area (AF area)

Select the desired AF area to suit the shooting conditions or your preference. The AF area where the focus has been confirmed turns green and the other AF areas disappear.

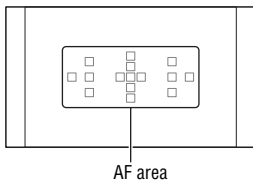

**Fn button** → [ ] (AF area) → **Select the desired setting**

|             |   |
|-------------|---|
| [ ] (Wide)  | The camera determines which of the 15 AF areas is used in focusing.   |
| ⋄⋄⋄ (Spot)  | The camera uses the AF area located in the center area exclusively.   |
| ⋄⋄⋄ (Local) | Choose the area for which you want to activate the focus from among 15 AF areas with the control button. Press the AF button to display the setup screen and select the desired area. |

### Notes

- When the exposure mode is set to AUTO, AUTO+, Sweep Panorama or Scene Selection, or the Smile Shutter is activated, [AF area] is fixed to [Wide] and you cannot select the other settings.
- The AF area may not be illuminated during continuous shooting or when the shutter button is pressed all the way down without pause.

## Adjusting the focus manually (Manual focus)

When it is difficult to get the proper focus in autofocus mode, you can adjust the focus manually.

- 1 Set the focus mode switch on the lens to MF.**

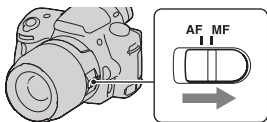

- 2 When the lens is not equipped with the focus mode switch, set the focus mode switch on the camera to MF.**

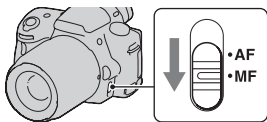

- 3 Rotate the focusing ring of the lens to achieve a sharp focus.**

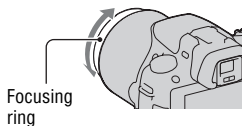

### Notes

- In the case of a subject that can be focused in autofocus mode, the ● indicator lights up when the focus is confirmed. When the Wide AF area is used, the center area is used, and when the Local AF area is used, the area that is selected with the control button is used.
- When using a tele converter (sold separately), etc., rotation of the focusing ring may not be smooth.
- The correct focus in the viewfinder is not achieved if the diopter is not adjusted properly in viewfinder mode (page 29).

## Checking the focus by enlarging the image



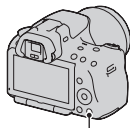

You can check the focus by enlarging the image before shooting.

**1 MENU button** →  **1** → **[Focus Magnifier]** → **[On]**

**2 Press the Focus Magnifier button.**



Focus Magnifier button

**3 Press the Focus Magnifier button again to enlarge the image and select the portion you want to enlarge with /// on the control button.**

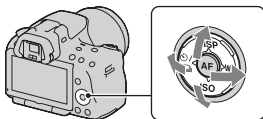

- Each time you press the Focus Magnifier button, the zoom scaling changes as follows: Full display → Approx.  $\times 7.5$  → Approx.  $\times 15$  (SLT-A55/A55V)/Full display → Approx.  $\times 7$  → Approx.  $\times 14$  (SLT-A33)

**4 Confirm and adjust the focus.**

- Rotate the focusing ring to adjust the focus in manual focus mode.
- If you press the AF button in autofocus mode, the Focus Magnifier function is canceled and the autofocus is activated.
- The Focus Magnifier function is canceled if you press the shutter button halfway down.

---

## **5 Press the shutter button fully down to shoot the image.**

- You can record images when an image is enlarged, however the recorded image is for full display.
  - The Focus Magnifier function will be released after shooting.
-



# Detecting faces

## Using the Face Detection function

The camera detects faces, adjusts the focus, exposure, performs image processing, and adjusts flash settings. The Face Detection function is set to [On] in the default setting.

### The Face Detection frame

When the camera detects faces, white Face Detection frames appear. When the camera judges that autofocus is possible, the Face Detection frames turn orange. When you press the shutter button halfway down, the Face Detection frames turn green.

- If a face is not positioned inside the AF area available when you press the shutter button halfway down, the AF area that is used for focusing turns green.
- When the camera detects multiple faces, the camera automatically selects a priority face and the single Face Detection frame turns orange.



Face Detection frames (white)

Face Detection frames (orange)

### To deactivate the Face Detection function

**Fn button** →  (Face Detection) → [Off]

#### Shooting technique

- Compose to overlay the Face Detection frame and the AF area.

#### Notes

- When the exposure mode is Sweep Panorama, Continuous Advance Priority AE, or during movie recording, the Face Detection function cannot be used.

- Up to eight faces can be detected.
- The camera may not detect any faces, or may detect some other object, depending on the shooting conditions.

## Capturing smiling faces (Smile Shutter)

When the camera detects a smile, the shutter is released automatically.

### 1 Fn button → ☺<sub>OFF</sub> (Smile Shutter) → [On] → Select the desired Smile Detection Sensitivity mode

- When the Smile Shutter is activated, the Smile Detection Sensitivity indicator appears on the screen.

### 2 Wait detecting a smile.

The camera detects a smile and the focus is confirmed. When the smile level exceeds the ◀ point on the indicator, the camera records images automatically.

- When the camera detects faces, orange Face Detection frames appear around the faces. The Face Detection frames turn green when these subjects come into focus.
- The smile level of the face surrounded by the double Face Detection frame is indicated on the Smile Detection Sensitivity indicator.

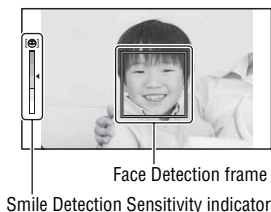

### 3 To stop shooting, Fn button → ☺<sub>ON</sub> (Smile Shutter) → [Off]

#### Smile Detection Sensitivity

You can set the sensitivity of the Smile Shutter function for detecting smiles to one of the following three options: ☺<sub>ON</sub> (Slight Smile), ☺<sub>ON</sub> (Normal Smile), and ☺<sub>ON</sub> (Big Smile).

## Shooting techniques

- To focus on the smile, overlay the Face Detection frame and AF area.
- Do not cover the eyes with bangs, etc. Keep the eyes narrowed.
- Do not obscure the face with a hat, a mask, sunglasses, etc.
- Try to orient the face in front of the camera and keep it as level as possible.
- Hold a clear smile with an open mouth. The smile is easier to detect when the teeth are showing.
- If you press the shutter button while the Smile Shutter function is activated, the camera shoots the image, and then returns to Smile Shutter.

## Notes

- When the exposure mode is set to Sweep Panorama or Continuous Advance Priority AE, the Smile Shutter function cannot be used.
- The drive mode is automatically set to [Single-shot Adv.] or [Remote Cdr.].
- The AF illuminator does not work with the Smile Shutter function.
- If the camera does not detect a smile, change the settings for Smile Detection Sensitivity.
- Smiles may not be detected correctly, depending on the shooting conditions.

# Using the flash

In a dark location, using the flash allows you to shoot the subject brightly, and it also helps to prevent camera shake. When shooting into the sun, you can use the flash to shoot a bright image of the backlit subject.

---

## 1 Fn button → ⚡ (Flash Mode) → Select the desired setting

---

## 2 Press the ⚡ button.

The flash pops up.

- In AUTO, AUTO+ or Scene Selection mode, the flash automatically pops up if the amount of light is insufficient or the subject is backlit. The built-in flash does not pop up even if you press the ⚡ button.

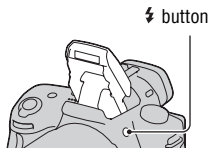







---

## 3 After the flash has finished charging, shoot the subject.

- Flashing: The flash is being charged. When the indicator flashes, you cannot release the shutter.
- Lit: The flash has been charged and is ready to fire.
- When you press the shutter button halfway down under dark lighting in autofocus mode, the flash may be fired to help focus on a subject (AF Illuminator).
- ● is indicated only in the recording information display (For Live View) mode.



● (Flash charging) indicator

|   |   |
|---|---|
|  <b>(Flash Off)</b>   | Does not fire even the built-in flash pops up.  |
|  <b>(Autoflash)</b>  | Fires if it is dark or against light.   |
|  <b>(Fill-flash)</b> | Fires every time you trigger the shutter.   |
|  <b>(Slow Sync.)</b> | Fires every time you trigger the shutter. Slow sync shooting allows you to shoot a clear image of both the subject and the background by slowing the shutter speed. |
|  <b>(Rear Sync.)</b> | Fires right before the exposure is completed everytime you trigger the shutter.   |
|  <b>(Wireless)</b>   | Fires an external flash (sold separately) that is off the camera and away from it (Wireless flash shooting).  |

### Shooting techniques

- The lens hood (sold separately) may block the light of the flash. Remove the lens hood when using the flash.
- When using the flash, shoot the subject at a distance of 1 m (3.3 feet) or greater.
- When shooting indoors or shooting nightscapes, you can use slow sync to shoot a brighter image of people and backgrounds.
- You can use rear sync to shoot a natural image of the trail of a moving subject such as a moving bicycle or a walking person.
- When using the HVL-F58AM/HVL-F42AM Flash (sold separately), you can shoot with the High-speed sync feature at any shutter speed. For details, refer to the operating instructions supplied with the flash.

### Notes



- Do not hold the camera by grabbing the flash emitter.
- Shooting conditions required to prevent shadows from appearing on an image vary, depending on the lens.
- When the exposure mode is set to AUTO, AUTO+, or Scene Selection, the [Slow Sync.], [Rear Sync.], and [Wireless] items cannot be selected.
- When the exposure mode is set to P, A, S, M, the [Flash Off] or [Autoflash] items cannot be selected. If you do not want to use the flash, push the flash down.
- If you use the flash with a stereo microphone or similar device attached to the Auto-lock Accessory shoe, the flash may not pop up to the correct position and recorded images may have a shadow on their corners. Remove any device from the Auto-lock Accessory shoe.

## The flash range

The range of the built-in flash depends on the ISO sensitivity and aperture value. Refer to the following table.

| Aperture    |     | F2.8                        | F4.0                        | F5.6                       |
|-------------|-----|-----------------------------|-----------------------------|----------------------------|
| ISO setting | 100 | 1 – 3.6 m (3.3 – 12 feet)   | 1 – 2.5 m (3.3 – 8.2 feet)  | 1 – 1.8 m (3.3 – 5.9 feet) |
|             | 200 | 1 – 5.1 m (3.3 – 17 feet)   | 1 – 3.5 m (3.3 – 12 feet)   | 1 – 2.5 m (3.3 – 8.3 feet) |
|             | 400 | 1.4 – 7.1 m (4.7 – 23 feet) | 1 – 5 m (3.3 – 16 feet)     | 1 – 3.6 m (3.3 – 12 feet)  |
|             | 800 | 2 – 10 m (6.6 – 33 feet)    | 1.4 – 7.1 m (4.6 – 23 feet) | 1 – 5.1 m (3.3 – 17 feet)  |

## The AF illuminator

- AF illuminator does not operate when [Autofocus Mode] is set to **AF-C** (Continuous AF) or the subject is moving in **AF-A** (Automatic AF). (The  or  indicator lights.)
- The AF illuminator may not operate with focal lengths of 300 mm or longer.
- When an external flash (sold separately) that is equipped with an AF illuminator is attached, the AF illuminator of the external flash is used.
- AF illuminator does not operate when [Smile Shutter] is set to [On].

## To deactivate the AF illuminator

**MENU button** →  **2** → [AF Illuminator] → [Off]

## To use the red-eye reduction

The red-eye reduction reduces the red-eye phenomenon by providing pre-flash (low-flash light) a few times before shooting when using the flash.

**MENU button** →  **1** → [Red Eye Reduction] → [On]

## Performing wireless flash shooting

With a flash that has a wireless shooting function (sold separately), you can shoot with the flash without a cord, even when the flash is not attached to the camera. By changing the position of the flash, you can shoot an image with a three dimensional feel by highlighting the contrast of light and shadow on the subject.

For the actual steps of shooting, refer to the operating instructions of the flash.

---

### 1 Attach the wireless flash to the Auto-lock Accessory shoe and turn both the camera and the flash on.

---

### 2 Fn button → (Flash Mode) → (Wireless)

---

### 3 Remove the wireless flash from the Auto-lock Accessory shoe and pop up the built-in flash.

- If you perform a test fire of the flash, press the AEL button.

---

#### Notes

- The camera cannot carry out the wireless lighting ratio control.
- Turn off the wireless flash mode after wireless flash shooting. If the built-in flash is used while the wireless flash mode is still active, inaccurate flash exposures will result.
- Change the channel of the external flash when another photographer is using a wireless flash nearby and his/her built-in flash light causes your external flash to fire. To change the channel of the external flash, refer to the operating instructions supplied with it.

#### Setup of the AEL button

When using a wireless flash, it is recommended that you set [AEL button] to [AEL hold] in the  Custom menu (page 150).

# Adjusting the brightness of the image (Exposure, Flash compensation, Metering)

## Shooting with fixed brightness (AE Lock)

When shooting into the sun or by a window, the exposure may not be appropriate for the subject because of the big difference in lighting between the subject and the background. In such cases, use the light meter where the subject is bright enough and lock the exposure before shooting. To reduce the brightness of the subject, point the camera forwards a spot that is brighter than the subject and use the light meter to lock the exposure of the entire image. To make the subject brighter, point the camera forwards a spot that is darker than the subject and use the light meter to lock the exposure of the entire image.

This section describes how to shoot a brighter image of the subject using the  (Spot).

The spot where you lock the exposure.



---

**1** Fn button →  (Metering Mode) →  (Spot)

---

**2** Adjust the focus on the portion you want to lock the exposure.

The exposure is set when the focus is achieved.



### 3 Press the AEL button to lock the exposure.

- \* (AE lock mark) appears.

AEL button

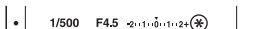
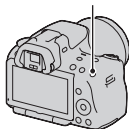

### 4 While pressing the AEL button, focus on the subject, and shoot the subject.

- If you continue to shoot with the same exposure value, press and hold the AEL button after the shooting. The setting is canceled when the button is released.

## Using brightness compensation for the entire image (Exposure compensation)

Except for exposure mode M, the exposure is automatically selected (Automatic exposure).

Based on the exposure acquired by the automatic exposure, you can perform exposure compensation by shifting the exposure to either the + side or the - side, depending on your preference. You can make the entire image brighter by shifting to the + side. The entire image becomes darker when you shift it to the - side.

Adjust in the -  
direction



Base exposure



Adjust in the +  
direction



## 1 Press the button.

 button

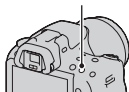

## 2 Adjust the exposure with the control dial.

Toward + (over): Brightens an image.

Toward – (under): Darkens an image.

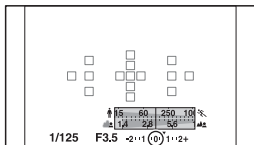

Standard exposure

## 3 Adjust the focus and shoot the subject.

### Shooting techniques

- Adjust the compensation level by checking the recorded image.
- Using bracket shooting, you can shoot multiple images with the exposure shifted to the plus or minus sides (page 118).

### Note

- This item cannot be set when the exposure mode is set to AUTO, AUTO+, or Scene Selection.

### To shoot while checking the screen using the histogram

The histogram displays the luminance distribution that shows how many pixels of a particular brightness exist in the picture.

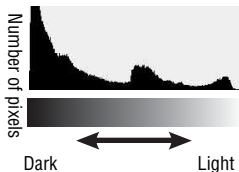

## MENU button → 2 → [Histogram] → [On]

- Instead of the Graphic Display, the histogram is displayed after you press DISP on the control button several times.

The exposure compensation will change the histogram accordingly. The right illustration is an example.

Shooting with the exposure compensation on the positive side brightens the whole picture, making the entire histogram shift to the bright side (right side). If the exposure compensation is applied on the negative side, the histogram will shift to the other side. Both ends of the histogram show a high-key or low-key portion. It is impossible to restore these area with a computer later. Adjust the exposure if necessary and shoot again.



### Notes

- The histogram does not indicate the final recorded image. It indicates the condition of the image just monitored on the screen. The histogram will differ based on aperture setting, etc.
- The histogram differs between shooting and playback in the following situations:
  - When firing the flash.
  - When the subject has low intensity, such as night scenery.

## Adjusting the amount of flash light (Flash Compensation)

When shooting with the flash, you can adjust the amount of flash light alone, without changing the exposure compensation. You can only change the exposure of a main subject which is within the flash range.

## **Fn button** → (Flash Compensation) → **Select the desired setting**

Toward +: Makes the flash level higher.

Toward -: Makes the flash level lower.

### **Notes**

- This item cannot be set when the exposure mode is set to AUTO, AUTO+, Sweep Panorama, or Scene Selection.
- The higher flash effect may not be visible due to the limited amount of flash light, if the subject is outside the maximum range of the flash. If the subject is very close, the lower flash effect may not be visible.

### **Exposure compensation and flash compensation**

Exposure compensation changes the shutter speed, aperture, and ISO sensitivity (when [AUTO] is selected) to perform the compensation.

Flash compensation only changes the amount of flash light.

Selecting the flash control mode to set the amount of flash light (Flash control)

## **MENU button** → 2 → [Flash control] → **Select the desired setting**

|                      |  |
|----------------------|--|
| <b>ADI flash</b>     | This method controls the lighting of the flash, factoring in the focus distance information and light metering data from the pre-flash. This method enables an accurate flash compensation with virtually no effect from the reflection off the subject. |
| <b>Pre-flash TTL</b> | This method controls the amount of flash light depending on the data only from pre-flash light metering. This method is susceptible to the reflection off the subject.   |

ADI: Advanced Distance Integration

TTL: Through the lens



- When [ADI flash] is selected, using a lens that is provided with a distance encoder feature can perform more accurate flash compensation by using more accurate distance information.

## Notes

- When the distance between the subject and the external flash (sold separately) cannot be determined (wireless flash shooting using an external flash (sold separately), shooting with an off-camera flash using a cable, shooting with a macro twin flash, etc.), the camera automatically selects Pre-flash TTL mode.
- Select [Pre-flash TTL] in the following cases, as the camera cannot perform flash compensations with ADI flash.
  - A wide panel is attached to the HVL-F36AM flash.
  - A diffuser is used for flash shooting.
  - A filter with an exposure factor, such as an ND filter, is used.
  - A close-up lens is used.
- ADI flash is only available in combination with a lens that is provided with a distance encoder. To determine if the lens is equipped with a distance encoder, refer to the operating instructions supplied with the lens.

## Selecting the method for measuring the brightness of a subject (Metering Mode)

**Fn button →  (Metering Mode) → Select the desired mode**

|  |  |
|--|--|
|  <b>(Multi segment)</b>   | This mode measures light on each area after dividing the total area into multiple areas and determines the proper exposure of the entire screen. |
|  <b>(Center weighted)</b> | While emphasizing the central area of the screen, this mode measures the average brightness of the entire screen.                                |
|  <b>(Spot)</b>            | This mode measures light only in the spot metering circle located in the center area.  |

## Shooting techniques

- Use [Multi segment] metering for general shooting.
- When there is a high contrast subject in the AF area, measure the light of the subject you want to shoot with the optimal exposure using the spot metering function and take advantage of an AE lock shooting (page 100).

## Note

- When the exposure mode is set to AUTO, AUTO+, or Scene Selection, [Metering Mode] is fixed to [Multi segment] and you cannot select other modes.

# Setting ISO

Sensitivity to light is expressed by the ISO number (recommended exposure index). The larger the number, the higher the sensitivity.

---

## 1 Press ISO on the control button to display the ISO screen.

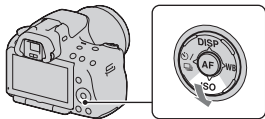

---

## 2 Select the desired setting with ▲/▼ on the control button.

- The larger the number, the higher the noise level.
- If you select [Multi Frame NR], select the desired value with ◀/▶.

---

### Notes

- When the exposure mode is set to AUTO, AUTO+, Sweep Panorama, or Scene Selection, ISO is fixed to AUTO and you cannot select other ISO numbers.
- When the exposure mode is set to P/A/S and ISO is set to [AUTO], ISO is automatically set between ISO 100 and ISO 1600.
- The [AUTO] setting is not provided in exposure mode M. If you change the exposure mode to M with the [AUTO] setting, it is switched to [100]. Set the ISO according to your shooting conditions.

### Multi frame noise reduction (Multi Frame NR)

The camera automatically shoots multiple images continuously, combines the images, reduces the noise, and records one image. In Multi Frame NR, you can select larger ISO numbers than the maximum ISO sensitivity. The image recorded is one combined image.

### Notes

- Press and hold the shutter button until the continuous shooting stops.
- When [Image: Quality] is set to [RAW] or [RAW & JPEG], this function cannot be used.
- The flash, D-Range optimizer, and [Auto HDR] cannot be used.

# Compensating for the brightness and contrast automatically (D-Range)

**D-RANGE button** → Select the desired setting

D-RANGE button

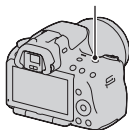

|                               |   |
|-------------------------------|---|
| <b>D-R OFF</b> (Off)          | Does not use the DRO/Auto HDR functions.  |
| <b>DRO</b> (D-RangeOptimizer) | By dividing the image into small areas, the camera analyses the contrast of light and shadow between the subject and the background, producing the image with the optimal brightness and gradation.   |
| <b>HDR</b> (Auto HDR)         | Shoots three images with different exposures, and then overlays correctly exposed image, the bright areas of an under exposed image and the dark areas of an over exposed image to create an image with rich gradation.<br>Two images are recorded: an image with the correct exposure and an overlaid image. |

## Correcting the brightness of the image (D-Range Optimizer)

**1 D-RANGE button** → **DRO** (D-RangeOptimizer)

**2 Select an optimal level with </> on the control button.**

|                        |   |
|------------------------|---|
| <b>DRO AUTO</b> (Auto) | Corrects the brightness automatically.  |
| <b>DRO</b> (Level)*    | Optimizes the gradations of a recorded image in each area of the image. Select the optimal level between Lv1 (weak) and Lv5 (strong). |

\* Lv\_ displayed with **DRO** is the step currently selected.



## Notes

- The setting is fixed to [Off] when [Sunset], [Night View], [Night Portrait], or [Handheld Twilight] is selected in Scene Selection. The setting is fixed to [Auto] when other modes are selected in Scene Selection.
- When shooting with the D-Range optimizer, the image may be noisy. Select the proper level by checking the recorded image, especially when you enhance the effect.

## Compensating automatically with rich gradation (Auto High Dynamic Range)

### 1 D-RANGE button → (Auto HDR)

### 2 Select an optimal level with on the control button.

|   |  |
|---|--|
|  (Auto Exposure Diff.)        | Corrects the exposure difference automatically.  |
|  (Exposure Difference Level)* | Sets the exposure difference, based on the contrast of the subject. Select the optimal level between 1.0Ev (weak) and 6.0Ev (strong).<br>For example: When 2.0Ev is selected, three images are overlaid: an image with -1.0Ev, an image with the correct exposure, and an image with +1.0Ev. |

\* \_Ev displayed with  is the step currently selected.

## Shooting technique

- Since the shutter is released three times for one shot, be careful about the following:
  - Use this function when the subject is motionless or does not blink.
  - Do not recompose.

## Notes

- You cannot use this function on RAW images.
- When the exposure mode is set to AUTO, AUTO+, Sweep Panorama, or Scene Selection, you cannot select [Auto HDR].



- You cannot select [Auto HDR] during Smile Shutter. If you turn on the Smile Shutter function with [Auto HDR] selected, the camera will temporarily use with the DRO setting.
- You cannot start the next shoot until the capture process is completed after you shoot.
- You may not obtain a desired effect depending on the luminance difference of a subject and the shooting conditions.
- When the flash is used, this function has little effect.
- When the contrast of the scene is low or when camera shake or subject blur is occurred, you may not obtain good HDR images. If the camera has detected a problem, **[HDR]** **[!]** is indicated on the recorded image to inform you of this situation. Shoot again, as necessary, paying attention to the contrast or blur.

# Image processing







## Selecting your desired image processing (Creative Style)

In addition to the desired image processing, you can adjust the exposure (shutter speed and aperture) as you like with [Creative Style], unlike Scene Selection where the camera adjusts the exposure.







---

**1 Fn button →  (Creative Style) → Select the desired setting**

---

**2 When you want to adjust  (Contrast),  (Saturation), or  (Sharpness), select the desired item with /  on the control button, then adjust the value with / .**

---

|   |   |
|---|---|
|  <b>(Standard)</b>            | For shooting various scenes with rich gradation and beautiful colors.   |
|  <b>(Vivid)</b>               | The saturation and contrast are heightened for shooting striking images of colorful scenes and subjects such as flowers, spring greenery, blue sky, or ocean views. |
|  <b>(Portrait)</b>            | For shooting the skin color in a soft tone, ideally suited to shooting portraits.   |
|  <b>(Landscape)</b>           | The saturation, contrast, and sharpness are heightened for shooting vivid and crisp scenery. Distant landscapes also stand out more.                                |
|  <b>(Sunset)</b>             | For shooting the beautiful red of the setting sun.  |
|  <b>(Black &amp; White)</b> | For shooting images in black and white monotone.  |

☉ (Contrast), 🌈 (Saturation), and 📏 (Sharpness) can be adjusted for each Creative Style item.

|                |  |
|----------------|--|
| ☉ (Contrast)   | The higher the value selected, the more the difference of light and shadow is accentuated, thus making an impact on an image.                                      |
| 🌈 (Saturation) | The higher the value selected, the more vivid the color. When a lower value is selected, the color of the image is restrained and subdued.                         |
| 📏 (Sharpness)  | Adjusts the sharpness. The higher the value selected, the more the contours are accentuated, and the lower the value selected, the more the contours are softened. |

### Notes

- When the exposure mode is set to AUTO, AUTO+, or Scene Selection, [Creative Style] is fixed to [Standard] and you cannot select other settings.
- When [Black & White] is selected, you cannot adjust the saturation.

## Changing the range of color reproduction (Color Space)

The way colors are represented with combinations of numbers or the range of color reproduction is called “color space.” You can change the color space, depending on your purpose.

**MENU button** → 📷 2 → [Color Space] → **Select the desired setting**





|          |   |
|----------|---|
| sRGB     | This is the standard color space of the digital camera. Use sRGB in normal shooting, such as when you intend to print out the images without any modification.  |
| AdobeRGB | This has a wide range of color reproduction. When a large part of the subject is vivid green or red, Adobe RGB is effective. <ul style="list-style-type: none"> <li>• The file name of the image starts with “_DSC.”</li> </ul> |

### Notes

- Adobe RGB is for applications or printers that support color management and DCF2.0 option color space. Using some applications or printers that do not support them may result in or print images that do not faithfully reproduce the color.
- When displaying images that were recorded with Adobe RGB on the camera or non-Adobe RGB-compliant devices, the images are displayed with low saturation.

# Adjusting the color tones (White balance)

The color tone of the subject changes depending on the characteristics of the light source. The table below shows how the color tone changes based on various light sources, compared with a subject that appears white under the sunlight.

|                          | Daylight  | Cloudy  | Fluorescent   | Incandescent  |
|--------------------------|---|---|---|---|
| Weather/lighting         |  |  |  |  |
| Characteristics of light | White   | Bluish  | Green-tinged  | Reddish   |



White balance is a feature that adjusts the color tone to approximate what you see. Use this feature when the color tone of the image did not come out as you expected, or when you want to change the color tone on purpose for photographic expression.

## Notes

- When the exposure mode is set to AUTO, AUTO+, or Scene Selection, [White Balance] is fixed to [Auto WB] and you cannot select other modes.
- If the only light source available is a mercury lamp or a sodium lamp, the camera will not be able to acquire the accurate white balance because of the characteristics of the light source. Use the flash in such cases.

## Adjusting the white balance to suit a specific light source (Auto/Preset white balance)

### WB on the control button → Select the desired setting

- When [AWB] is not selected, you can fine tune the color tone with  . Adjusting it toward + turns the image reddish and adjusting it toward – turns the image bluish.

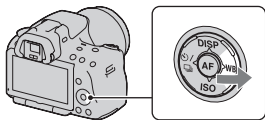

|                         |  |
|-------------------------|--|
| <b>AWB (Auto WB)</b>    | The camera automatically detects a light source and adjusts the color tones.   |
| <b>☀ (Daylight)</b>     | If you select an option to suit a specific light source, the color tones are adjusted for the light source (preset white balance). |
| <b>🏠 (Shade)</b>        |  |
| <b>☁ (Cloudy)</b>       |  |
| <b>💡 (Incandescent)</b> |  |
| <b>💡 (Fluorescent)</b>  |  |
| <b>WB (Flash)</b>       |  |

### Shooting techniques

- Use the white balance bracket function if you cannot get the desired color in the selected option (page 119).
- When you select [5500K] (Color Temp.) or [0] (Color Filter), you can adjust the value to the desired value (below).
- When you select [Custom], you can register your setting (page 114).

### Setting the color temperature and a filter effect (Color Temperature/Color Filter)

#### WB on the control button → [5500K] (Color Temp.) or [0] (Color Filter)

- To set the color temperature, select the value with ◀/▶.
- To set the color filter, select the compensation direction with ◀/▶.

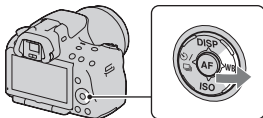

#### Note

- Since color meters are designed for film cameras, the values differ under fluorescent/sodium lamp/mercury lamps. We recommend that you use the custom white balance or do a test shooting.

|                              |  |
|------------------------------|--|
| <b>5500K*1 (Color Temp.)</b> | Sets the white balance by the color temperature. The higher the number, the more reddish the image and the lower the number, the more bluish the image.  |
| <b>0*2 (Color Filter)</b>    | Achieves the effect of CC (Color Compensation) filters for photography.<br>Based on using the set color temperature as the standard, the color can be compensated to G (Green) or M (Magenta). |

\*1 The value is the color temperature value currently selected.

\*2 The value is the color filter value currently selected.

## Registering the color tones (Custom white balance)

In a scene where the ambient light consists of multiple types of light source, use of custom white balance is recommended in order to accurately reproduce the whiteness.

### 1 WB on the control button → [WB] (Custom)

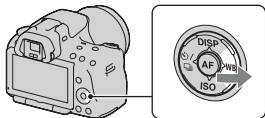

### 2 Select [WB] SET with ◀/▶ on the control button, then press the center of the control button.

### 3 Hold the camera so that the white area fully covers the AF area located in the center, and then press the shutter button down.

The shutter clicks and the calibrated values (ColorTemperature and Color filter) are displayed.

### 4 Press the center of the control button.

The monitor returns to the recording information display with the memorized custom white balance setting retained.

- The custom white balance setting registered in this operation is effective until a new setting is registered.

## Note

- The message “Custom WB error” indicates that the value is beyond the expected range. (When the flash is used on a subject in close proximity or a subject with a bright color is in the frame.) If you register this value, the  indicator turns yellow on the recording information display. You can shoot at this point, but it is recommended that you set the white balance again to get a more correct white balance value.

## To call the custom white balance setting

### WB on the control button →

 (Custom)

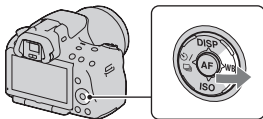

## Note

- If the flash is used when the shutter button is pressed, a custom white balance is registered with the flash light taken into account. Take pictures with the flash in later shootings.

## **Selecting the drive mode**

This camera has six drive modes, such as single-shot advanced, and continuous advanced. Use them to suit your purpose.

### Shooting single shot

This mode is for normal shooting.

 **on the control button** →  
 **(Single-shot Adv.)**

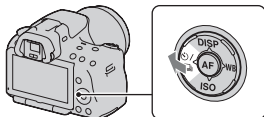



#### Note



- When the exposure mode is set to [Sports Action] in Scene Selection, you cannot shoot single shot.

### Shooting continuously

The camera records the images continuously at the following speeds\*.

|   | SLT-A55/A55V                | SLT-A33                       |
|---|-----------------------------|-------------------------------|
|  Hi | Maximum 6 images per second | Maximum 6 images per second   |
|  Lo | Maximum 3 images per second | Maximum 2.5 images per second |

\* Our measurement conditions. The speed of continuous shooting is slower, depending on shooting conditions.

**1**  **on the control button** →  
 **(Continuous adv.)** → **Select the desired speed**

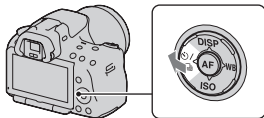

### **2** Adjust the focus and shoot the subject.

- When you press and hold the shutter button, the recording continues.



## The maximum number of continuous shots

The number of continuous shooting images obtainable has an upper limit.

In Continuous Advance Priority AE mode

|                       | SLT-A55/A55V | SLT-A33   |
|-----------------------|--------------|-----------|
| <b>Fine</b>           | 28 images    | 14 images |
| <b>Standard</b>       | 28 images    | 16 images |
| <b>RAW &amp; JPEG</b> | 19 images    | 7 images  |
| <b>RAW</b>            | 19 images    | 7 images  |

### Shooting technique

- To shoot continuously faster, set the exposure mode to Continuous Advance Priority AE (page 69).

### Notes

- When  $\square_{HI}$  is selected, the image recorded between the frames is displayed.
- You cannot shoot continuously when using Scene Selection modes other than [Sports Action].
- When [Face Detection] is set to [On], the speed of continuous shooting may be slower.

## Using the self-timer

The 10-second self-timer is convenient when the photographer appears in a photo and the 2-second self-timer is convenient to reduce the camera shake.

- 1  $\odot$  /  $\square_{HI}$  on the control button →  $\odot$  (Self-timer) → Select the desired setting

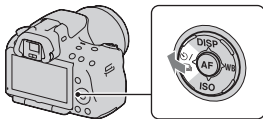

- The number after  $\odot$  is the number of seconds that is currently selected.



- 2 Adjust the focus and shoot the subject.

- When the self-timer is activated, audio signals and the self-timer lamp indicate the condition. The self-timer lamp flashes quickly and the audio signal sounds quickly right before the shooting.

## To cancel the self-timer

Press  /  on the control button.

## Shooting images with the exposure shifted (Exposure bracket)



Base exposure





- direction



+ direction

Bracket shooting allows you to shoot several images, each with different degrees of exposure. Specify the value of deviation (steps) from the base exposure, and the camera shoots three images while automatically shifting the exposure. Press and hold the shutter button until the shooting stops. When the flash is fired, flash bracket shooting is used to shift the amount of flash light. To shoot, press the shutter button shot by shot.

- 1  /  on the control button → **BRK C (Bracket: Cont.)** → Select the desired bracket step

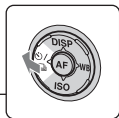
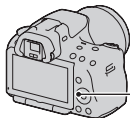

## 2 Adjust the focus and shoot the subject.



The base exposure is set at the first shot in the bracket.

- Press and hold the shutter button until recording stops. In flash bracket shooting, press the shutter button three times.

### Notes

- When the mode dial is set to M, the exposure is shifted by adjusting the shutter speed.
- When you adjust the exposure, the exposure is shifted based on the compensated value.
- The bracket cannot be used when the exposure mode is set to AUTO, AUTO+, Sweep Panorama, or Scene Selection.

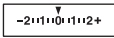
## The EV scale in bracket shooting

|   | Ambient light* bracket<br>0.3 steps, three shots<br>Exposure compensation 0                                | Flash bracket<br>0.7 steps, three shots<br>Flash compensation -1.0  |
|---|--|---|
| LCD monitor/<br>Viewfinder  |                           |                              |
| LCD monitor (When<br>[Display Rec. Data] is<br>set to [For viewfinder]) | <br>Shown in the top row. | <br>Shown in the bottom row. |

\* Ambient light: Any light other than the flash light that shines on the scene for an extended period of time, such as natural light, a light bulb, or a fluorescent light.

- In bracket shooting, the same number of indices as the number of recordable images is displayed on the EV scale.
- When the bracket shooting starts, the indices that indicate already recorded images start to disappear one by one.

## Shooting with white balance shifted (WB bracket)

Based on the selected white balance, and the color temperature/color filter, three images are recorded with the white balance shifted.

- 1  on the control button → **BRK WB (WB bracket) → Select the desired setting**

- When Lo is selected, it is shifted by 10 mired\*, and when Hi is selected, it is shifted by 20 mired.

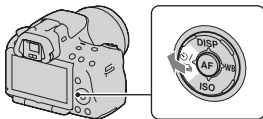



## 2 Adjust the focus and shoot the subject.

\* Mired: a unit to indicate the color conversion quality in color temperature filters.

## Shooting with the Wireless Remote Commander

You can shoot using the SHUTTER and 2SEC (the shutter is released after 2 seconds) buttons on the RMT-DSLR1 Wireless Remote Commander (sold separately). Also, refer to the operating instructions supplied with the Wireless Remote Commander.

- 
- 1**  /  on the control button →  
 (Remote Cdr.)

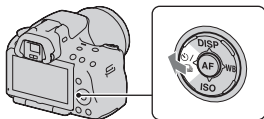

- 
- 2** Focus on the subject, point the transmitter of the Wireless Remote Commander to the remote sensor, and shoot the image.
-

# Playing back images

The last recorded image is displayed on the LCD monitor.

**1** Press the  button.

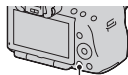

 button

**2** Select an image with /  on the control button.

**To return to the shooting mode**

Press the  button again.

**To switch the recording data display**

Press DISP on the control button.

Each time you press DISP on the control button, the screen changes as follows.

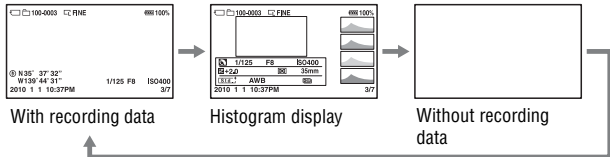

**To select the folder to be played back**

**MENU button** →  **2** → [Select Folder] → Select the desired folder

**To select the orientation when playing back an image recorded in the portrait position**

**MENU button** →  **2** → [Playback Display] → Select the desired setting

## Note

- When you play back the image on a TV or a computer, the image will be displayed in the portrait position even if [Manual Rotate] is selected.

## To scroll panoramic images

Select a panoramic image, then press the center of the control button.

Pressing it again pauses the playback.

3D Sweep Panorama images cannot be scrolled. Scrolling playback is not available for images that were recorded with [3D Pan.: Image Size] set to [16:9].

## Playing back movies

**1 MENU button** →  **1** → [Still/Movie Select] → [Movie]

**2 Select the desired movie with ◀/▶ on the control button, then press the center of the control button.**

| During movie playback      | Control button/control dial operation             |
|----------------------------|---|
| To pause/resume            | ●   |
| To fast-forward            | ▶   |
| To fast-rewind             | ◀   |
| To slow-forward            | Rotate the control dial to the right during pause |
| To slow-reverse            | Rotate the control dial to the left during pause  |
| To adjust sound volume     | ▼ → ▲/▼   |
| To display the information | ▲   |

## To adjust the volume

**MENU button** →  **2** → [Volume Settings] → Select the desired valve

## To select the date of movies to be played back

Movies are stored by date.

**MENU button** →  **2** → **[Select Date]** → **Select the desired date**

### Note

- Movies recorded with other devices may not be played back on this camera.

## Rotating an image

**1 Display the image you want to rotate, then press the  button.**

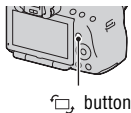

**2 Press the center of the control button.**

The image is rotated counter-clockwise. When you want to do another rotation, repeat step 2.

- Once you rotate the image, the image is played back in the rotated position, even if you turn off the power.

### To return to the normal playback screen

Press the  button.

### Notes

- You cannot rotate movies.
- When you copy rotated images to a computer, "PMB" contained on the CD-ROM (supplied) can display the rotated images correctly. However, the images may not be rotated depending on the software.

## Enlarging images

A still image can be enlarged for closer examination. This is convenient to check the focus condition of a recorded image.

### 1 Display the image you want to enlarge, then press the $\oplus$ button.

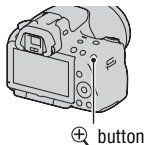

### 2 Zoom the image in or out with the $\oplus$ button or $\ominus$ button.

- Rotating the control dial switches the image at the same display magnification. When you shoot multiple images with the same composition, you can compare their focus conditions.

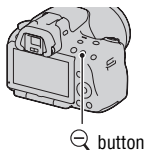

### 3 Select the portion you want to enlarge with $\blacktriangle/\blacktriangledown/\blacktriangleleft/\blacktriangleright$ on the control button.

#### To cancel the enlarged playback

Press the  $\blacktriangleright$  button so that the image returns to the normal size.

#### Scaling range

The scaling range is as follows.

| Image size | Scaling range                      |                                    |
|------------|------------------------------------|------------------------------------|
|            | SLT-A55/A55V                       | SLT-A33                            |
| L          | Approx. $\times 1.1 - \times 11.8$ | Approx. $\times 1.1 - \times 11.8$ |
| M          | Approx. $\times 1.1 - \times 8.8$  | Approx. $\times 1.1 - \times 8.0$  |
| S          | Approx. $\times 1.1 - \times 6.0$  | Approx. $\times 1.1 - \times 5.5$  |



## Switching to the display of the image list



**MENU button** →  **1** → **[Image Index]** → **Select the desired number of images to be displayed on one page**

- You can also display the image list using the  button.

### To return to the single-image screen

Press the center of the control button when you select the desired image.

### To turn to the movie index screen

To display movies on the image index screen, select  (movie) on the tab with /  on the control button, then press the center of the control button.





Still image/movie switching tab

## Playing back images automatically (Slide show)

**MENU button** →  **1** → **[Slide Show]** → **[Enter]**

Plays back recorded images in order (Slide show). The slide show automatically stops after all the images have been played back.

- You can view the previous/next image with /  on the control button.
- You cannot pause the slide show.

### To end in the middle of the slide show

Press the center of the control button.

### To choose the interval between the images in slide show

**MENU button** →  **1** → **[Slide Show]** → **[Interval]** → **Select the desired number of seconds**

### To play back repeatedly

**MENU button** →  **1** → **[Slide Show]** → **[Repeat]** → **[On]**

### **To play back movies**

You cannot play back still images and movies in the same slide show. Switch to a movie playback with [Still/Movie Select], then select the movie type.

**MENU button** →  **1** → **[Slide Show]** → **[Movie Type]** →  
**Select the desired movie type**

### **To play back 3D-images**

If you connect the camera to a 3D-compatible TV using an HDMI cable (sold separately), you can play back 3D-images recorded with the 3D Sweep Panorama mode. For details on 3D-shooting, see page 198. Also refer to the operating instructions supplied with the TV.

**MENU button** →  **1** → **[Slide Show]** → **[Image Type]** →  
**[Display 3D Only]**

# Checking the information of recorded images

Each time you press DISP on the control button, the information display changes (page 121).

## Basic information display

### Still image

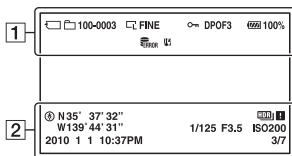

### Movie

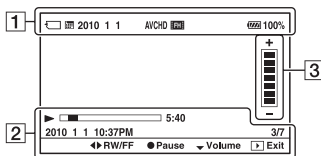





1

| Display  | Indication   |
|--|--|
|  | Memory card (20)   |
|  | Still image/Movie  |
| <b>100-0003</b>  | Folder - file number (166)   |
| <b>2010 1 1</b>  | Recording date   |
| <br><b>WIDE</b><br><br><b>STD</b><br><b>3D 16:9</b><br><b>3D STD</b><br><b>3D WIDE</b> | Image size of still images (141)/Aspect ratio of still images (143)/Image size of panoramic images (142) |
| <b>RAW</b><br><b>RAW+J</b><br><b>FINE</b><br><b>STD</b>                                | Image quality of still images (143)  |
|  | Protect (131)  |

| Display                                 | Indication  |
|---|---|
| <b>DPOF3</b>                            | DPOF set (172)                                      |
|   | Remaining battery warning (22)                      |
|   | Remaining battery (22)                              |
|   | Database file full (190)/ Database file error (190) |
|   | Overheating warning (190)                           |
| <b>AVCHD</b><br><b>MP4</b>              | Movie file format (82)                              |
| <br><b>FH</b> <b>1080</b><br><b>VGA</b> | Image size of movies (142)                          |

2

| Display  | Indication                                     |
|--|--|
|  | GPS information (SLT-A55V only)                |
| <b>N35° 37' 32"</b><br><b>W139° 44' 31"</b>                                      | Latitude and longitude display (SLT-A55V only) |
| <b>2010 1 1</b><br><b>10:37AM</b>  | Date of recording                              |
|  | Auto HDR image warning (108)                   |
| <b>1/125</b>   | Shutter speed (75)                             |
| <b>F3.5</b>  | Aperture (72)                                  |
| <b>ISO200</b>  | ISO sensitivity (106)                          |
| <b>3/7</b>   | File number/total number of images             |
|  | Playback                                       |
|  | Playback bar                                   |
| <b>5:40</b>  | Counter  |

3

| Display  | Indication |
|--|------------|
|  | Volume     |

# Histogram display

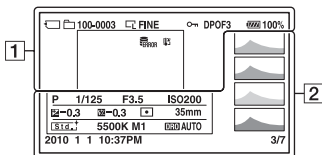

1

| Display   | Indication   |
|---|--|
|   | Memory card (20)   |
|   | Still image  |
| <b>100-0003</b>   | Folder - file number (166)   |
|   | Image size of still images (141)/Aspect ratio of still images (143)/Image size of panoramic images (142) |
|   |  |
| <b>RAW</b><br><b>RAW+J</b><br><b>FINE</b><br><b>STD</b> | Image quality of still images (143)  |
|   | Protect (131)  |
| <b>DPOF3</b>  | DPOF set (172)   |
|   | Remaining battery warning (22)   |
| <b>100%</b>   | Remaining battery (22)   |
| <b>FULL</b><br><b>ERROR</b>                             | Database file full (190)/<br>Database file error (190)   |
|   | Overheating warning (190)  |

2

| Display   | Indication  |
|---|---|
|   | Histogram* (102)  |
| <b>AUTO</b> <b>AUTO+</b><br><b>STD</b><br><b>P A</b><br><b>S M</b><br><br>        | Exposure mode (59 – 80)<br>•  (SLT-A55/A55V)/<br>(SLT-A33)                  |
| <b>1/125</b>  | Shutter speed (75)  |
| <b>F3.5</b>   | Aperture (72)   |
| <b>ISO200</b>   | ISO sensitivity (106)   |
| <b>-0.3</b>   | Exposure compensation (101)   |
| <b>-0.3</b>   | Flash compensation (103)  |
|   | Metering mode (105)   |
| <b>35mm</b>   | Focal length (176)  |
| <b>Std.</b> <b>Vivid</b><br><b>Port.</b> <b>Land.</b><br><b>Sunset</b> <b>B/W</b> | Creative Style (110)  |
| <b>AWB</b> <b>+1</b><br><b>5500K M1</b>   | White balance (Auto, Preset, Color temperature, Color filter, Custom) (112) |
| <b>D-R OFF</b><br><b>DRO</b> <b>HDR</b><br><b>HDR</b>                             | D-Range Optimizer (107)/Auto HDR/Auto HDR image warning (108)               |

| <b>Display</b>              | <b>Indication</b>                  |
|-----------------------------|------------------------------------|
| <b>2010 1 1<br/>10:37AM</b> | Date of recording                  |
| <b>3/7</b>                  | File number/total number of images |

\* When the image has a high-key or low-key portion, that portion is flashed on the histogram display (Luminance limit warning).

# Protecting images (Protect)

You can protect images against accidental erasure.

Protecting selected images/canceling the protection of the selected images

**1** MENU button →  1 → [Protect] → [Multiple Img.]

**2** Select the image you want to protect with ◀/▶ on the control button, then press the center of the control button.

A  mark appears on the selected image.

- To cancel a selection, press the center again.

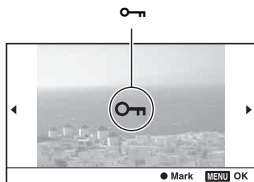

**3** To protect other images, repeat step 2.

**4** Press the MENU button.

**5** Select [Enter] with ▲, then press the center of the control button.

## To cancel the protection of all the images or movies

You can cancel the protection of all the images in the folder currently selected or of all the movies with the same date.

MENU button →  1 → [Protect] → [Cancel All Images] or [Cancel All Movies]

# Deleting images (Delete)

Once you have deleted an image, you cannot restore it. Check whether to delete the image or not beforehand.

## Note

- Protected images cannot be deleted.

## Deleting the image that is currently displayed

- 1** Display the image you want to delete and press the  button.

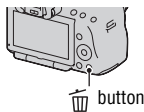

- 2** Select [Delete] with **▲** on the control button, then press the center of the control button.

## Deleting the selected images

- 1** MENU button →  1 → [Delete] → [Multiple Img.]

- 2** Select the images you want to delete with the control button, then press the center of the control button.

A  mark appears on the selected image.

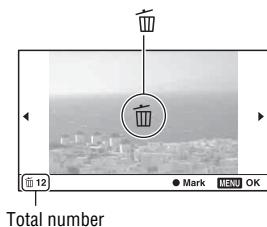

- 3** To delete other images, repeat step 2.



---

**4 Press the MENU button.**

---

**5 Select [Delete] with ▲, then press the center of the control button.**

---

#### Deleting all the images in the folder

Deletes all still images in the folder. This appears during still image playback only.

---

**1 MENU button →  1 → [Delete] → [All in Folder]**

---

**2 Select [Delete] with ▲ on the control button, then press the center of the control button.**

---

#### Deleting all the movies with the same date

Deletes all movies of that date. This appears during movie playback only.

---

**1 MENU button →  1 → [Delete] → [All in Date Rng.]**

---

**2 Select [Delete] with ▲ on the control button, then press the center of the control button.**

---

# Viewing images on a TV screen

To view images recorded on the camera on a TV set, an HDMI cable (sold separately) and an HD TV equipped with an HDMI connector are required.

## 1 Turn off both your camera and the TV, and connect the camera to the TV.

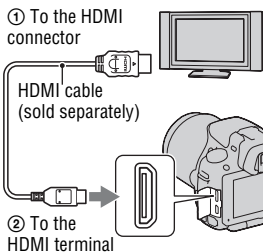

## 2 Turn on the TV and switch the input.

- See also the operating instructions supplied with the TV.

## 3 Turn on the camera.

Images shot with the camera appear on the TV screen.

Select the desired image with ◀/▶ on the control button.

- The LCD monitor on the camera does not turn on.

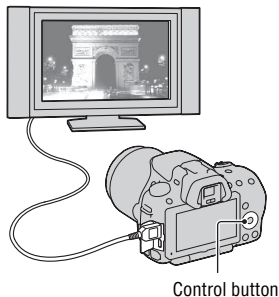

### Notes

- Use an HDMI cable with the HDMI logo.
- Use an HDMI mini connector on one end (for the camera), and a connector suitable for connection to your TV on the other end.
- Some devices may not work properly.

- Do not connect the output connector of the device with the HDMI terminal on the camera. This may cause a malfunction.

### **On “PhotoTV HD”**

This camera is compatible with the “PhotoTV HD” standard.

By connecting Sony’s PhotoTV HD-compatible devices using an HDMI cable, a whole new world of photos can be enjoyed in breathtaking Full HD quality.

“PhotoTV HD” allows for a highly-detailed, photo-like expression of subtle textures and colors.

### **On “<BRAVIA> Photo Map” (SLT-A55V only)**

This camera is compatible with the “<BRAVIA> Photo Map” standard.

By connecting the camera to a TV that supports “<BRAVIA> Photo Map” using a USB cable, you can display the shooting location on the map when the image is recorded with the location information.

### **To view 3D-images with a 3D-compatible TV**

If you connect the camera to a 3D-compatible TV using an HDMI cable (sold separately), you can play back 3D-images recorded with the 3D Sweep Panorama mode automatically. For details on 3D-shooting, see page 198. Also refer to the operating instructions supplied with the TV.

**MENU button** →  **1** → **[3D Viewing]**

## Using “BRAVIA” Sync

By connecting the camera to a TV that supports “BRAVIA” Sync using an HDMI cable, you can operate the camera with the TV Remote Control.

### 1 Connect a TV that supports “BRAVIA” Sync to the camera (page 134).

The input is automatically switched and the image shot with the camera appears on the TV screen.

### 2 Press the SYNC MENU button on the TV Remote Control.

### 3 Operate with the buttons on the TV Remote Control.

#### The items for Sync Menu

|                              |  |
|------------------------------|--|
| <b>Slide Show</b>            | Plays back images automatically (page 125).                |
| <b>Single-image playback</b> | Returns to the single-image screen.                        |
| <b>Still/Movie Select</b>    | Selects still images or movies to be played back.          |
| <b>Image Index</b>           | Switches to the image index screen.                        |
| <b>3D Viewing</b>            | Plays back 3D-images when connected to a 3D-compatible TV. |
| <b>Select Folder</b>         | Selects the folder of images to be played back.            |
| <b>Select Date</b>           | Selects the date of movies to be played back.              |
| <b>Delete</b>                | Deletes images.  |

#### Notes

- The operations available are restricted when the camera is connected to a TV using an HDMI cable.
- Only TVs that support “BRAVIA” Sync can provide these operations. The SYNC Menu operations differ depending on the TV connected. For details, refer to the operating instructions supplied with the TV.
- If the camera performs unnecessary operations in response to the TV Remote Control when the camera is connected to another manufacturer’s TV using an HDMI connection, set [CTRL FOR HDMI] in the  Setup menu to [Off].

## To use your camera abroad

When you view images on a TV screen, the camera and TV must use the same TV color system.

### **NTSC system (1080 60i)**

Bahama Islands, Bolivia, Canada, Central America, Chile, Colombia, Ecuador, Jamaica, Japan, Korea, Mexico, Peru, Surinam, Taiwan, the Philippines, the U.S.A., Venezuela, etc.

### **PAL system (1080 50i)**

Australia, Austria, Belgium, China, Croatia, Czech Republic, Denmark, Finland, Germany, Holland, Hong Kong, Hungary, Indonesia, Italy, Kuwait, Malaysia, New Zealand, Norway, Poland, Portugal, Rumania, Singapore, Slovak Republic, Spain, Sweden, Switzerland, Thailand, Turkey, United Kingdom, Viet Nam, etc.

### **PAL-M system (1080 50i)**

Brazil

### **PAL-N system (1080 50i)**

Argentina, Paraguay, Uruguay

### **SECAM system (1080 50i)**

Bulgaria, France, Greece, Guiana, Iran, Iraq, Monaco, Russia, Ukraine, etc.





# GPS setting (SLT-A55V only)

If the camera has acquired location information using the built-in GPS feature, this information is recorded in the images or movies at that location.

Using the supplied software “PMB,” you can import images recorded with location information to a computer and enjoy viewing them with a map which shows their shooting location. See “PMB Help” for details.

**MENU button** →  **1** → **[GPS Settings]** → **[GPS On/Off]** → **[On]**

The indicator changes according to the strength of GPS signal reception.

| GPS indicators   | GPS reception status  |
|--|---|
| No indicator   | [GPS On/Off] is set to [Off].   |
|  | Your camera cannot record the location information. Use your camera in an open area.  |
|  | Calculating the location information. Wait until the location information is recordable.  |
|  | The last acquired location information will be recorded. To record the correct location information, use your camera in an open area. |
|  | The current location information is recordable.   |
|  | There is a problem with the GPS feature. Turn the camera off and on.  |

## To receive a GPS signal

- Proper triangulation is not possible indoors or near tall buildings. Use your camera in an open area outside, and turn on your camera again.
- It may take several tens of seconds to several minutes to acquire the location information. You can shorten the positioning time by using GPS assist data.

## Notes

- Right after you turn the camera on, it may take several tens of seconds to several minutes to acquire the location information. If the information cannot be acquired, previously-triangulated location information is used in the present location instead. If you are away from the location where you previously turned the camera off, the location information may have a considerable margin of error. To record the correct information, wait until the camera can receive radio signals from GPS satellites.
- During take off and landing of an airplane, turn off the camera, as you will be instructed to do by the on-board announcement.

- Use GPS in accordance with the regulations of the place or situation.
- For detailed notes on the GPS feature, see page 196.

## Shortening the time needed for the GPS to acquire location information (GPS assist data)

The time for the GPS acquiring location information can be shortened by taking in GPS assist data.

If the camera connects to the computer that the supplied “PMB” software has been installed, the GPS assist data can be updated automatically.

### To check the state of GPS assist data

**MENU button** →  1 → [GPS Settings] → [Use GPS Assist Data]

### To delete GPS assist data

**MENU button** →  1 → [GPS Settings] → [Delete GPS Ass. Data]

### Notes

- The computer is required to connect to the Internet when updating data.
- If the term of validity of assist data has run out, the time until you can record location information cannot be shortened. It is recommended that you update the assist data regularly. The expiration date of the assist data is about 30 days.
- If [Date/Time Setup] is not set, or set time is shifted greatly, the time for the GPS acquiring location information cannot be shortened.
- The assist data service may be closed for various reasons.

### To update the GPS assist data by inserting a memory card into the computer

Start up [GPS Support Tool] from  (PMB Launcher), select the memory card drive from your computer, and then update the GPS assist data. Insert the memory card that has been updated into the camera.

## Correcting clock time automatically

Your camera maintains correct clock time by using GPS to acquire time information during starting up. The time is corrected when the power is turned off.

**MENU button** →  **1** → **[GPS Settings]** → **[GPS Auto Time Cor.]**  
→ **[On]**

### Notes

- [GPS Auto Time Cor.] is invalid if [GPS On/Off] is set to [Off].
- You must set [Date/Time Setup] on the camera before using it.
- There may be discrepancies of a few seconds.
- Depending on the area, it may not function correctly.



# Setting image size and image quality

## Image: Size

**MENU button** →  **1** → **[Image: Size]** → **Select the desired size**

**[Image: Aspect Ratio]: [3:2]**

**SLT-A55/A55V**

| Image size    |                    | Usage guidelines          |
|---------------|--------------------|---------------------------|
| <b>L:16M</b>  | 4912 × 3264 pixels | For prints up to A3+ size |
| <b>M:8.4M</b> | 3568 × 2368 pixels | For prints up to A4 size  |
| <b>S:4.0M</b> | 2448 × 1624 pixels | For prints L/2L size      |

**SLT-A33**

| Image size    |                    | Usage guidelines          |
|---------------|--------------------|---------------------------|
| <b>L:14M</b>  | 4592 × 3056 pixels | For prints up to A3+ size |
| <b>M:7.4M</b> | 3344 × 2224 pixels | For prints up to A4 size  |
| <b>S:3.5M</b> | 2288 × 1520 pixels | For prints L/2L size      |

**[Image: Aspect Ratio]: [16:9]**

**SLT-A55/A55V**

| Image size    |                    | Usage guidelines                    |
|---------------|--------------------|-------------------------------------|
| <b>L:14M</b>  | 4912 × 2760 pixels | For viewing on a high-definition TV |
| <b>M:7.1M</b> | 3568 × 2000 pixels |                                     |
| <b>S:3.4M</b> | 2448 × 1376 pixels |                                     |

**SLT-A33**

| Image size    |                    | Usage guidelines                    |
|---------------|--------------------|-------------------------------------|
| <b>L:12M</b>  | 4592 × 2576 pixels | For viewing on a high-definition TV |
| <b>M:6.3M</b> | 3344 × 1872 pixels |                                     |
| <b>S:2.9M</b> | 2288 × 1280 pixels |                                     |

### Note



- When you select a RAW image with [Image: Quality], the image size of the RAW image corresponds to L. This size is not displayed on the screen.

## Setting the size of panoramic images



You can set the image size of panoramic images. The image size varies depending on the setting of the shooting direction (page 68).

**MENU button** →  **2** → **[Panorama: Size]** or **[3D Pan.: Image Size]** → **Select the desired size**

### [Panorama: Size]

|  |   |
|--|---|
|  <b>STD (Standard)</b> | Vertical: 3872 × 2160<br>Horizontal: 8192 × 1856  |
|  <b>WIDE (Wide)</b>    | Vertical: 5536 × 2160<br>Horizontal: 12416 × 1856 |

### [3D Pan.: Image Size]

|  |                         |
|--|-------------------------|
|  <b>16:9 (16:9)</b>    | Horizontal: 1920 × 1080 |
|  <b>STD (Standard)</b> | Horizontal: 4912 × 1080 |
|  <b>WIDE (Wide)</b>    | Horizontal: 7152 × 1080 |

## Movie: Size



The larger the image size, the higher the image quality.

**MENU button** →  **1** → **[Movie: Size]** → **Select the desired size**

### [AVCHD] mode

|   |  |
|---|--|
|  <b>(1920 × 1080)</b> | 17 Mbps: Records with the highest image quality for viewing on a high-definition TV. |
|---|--|

### [MP4] mode

|   |   |
|---|---|
|  <b>(1440 × 1080)</b>     | 12 Mbps: Records with high image quality for viewing on a high-definition TV. |
|  <b>(VGA) (640 × 480)</b> | 3 Mbps: Records in the suitable size for WEB uploads.                         |

## Note

- A telephoto image results except when the [VGA] image size is selected for movies (SLT-A33 only).

## Image: Aspect Ratio

**MENU button** →  **1** → **[Image: Aspect Ratio]** → **Select the desired ratio**

|             |                 |
|-------------|-----------------|
| <b>3:2</b>  | A normal ratio. |
| <b>16:9</b> | An HDTV ratio.  |

## Note

- This item cannot be set when the exposure mode is set to Sweep Panorama.

## Image: Quality

**MENU button** →  **1** → **[Image: Quality]** → **Select the desired setting**

|                               |  |
|-------------------------------|--|
| <b>RAW (RAW)</b>              | File format: RAW (Records using the RAW compression format.)<br>This format does not perform any digital processing on the images. Select this format to process images on a computer for professional purposes. <ul style="list-style-type: none"><li>• The image size is fixed to the maximum size. The image size is not displayed on the screen.</li></ul> |
| <b>RAW+J (RAW &amp; JPEG)</b> | File format: RAW (Records using the RAW compression format.) + JPEG<br>A RAW image and a JPEG image are created at the same time. This is suitable when you need two image files, a JPEG for viewing, and a RAW for editing. <ul style="list-style-type: none"><li>• The image quality is fixed to [Fine] and the image size is fixed to [L].</li></ul>        |
| <b>FINE (Fine)</b>            | File format: JPEG  |
| <b>STD (Standard)</b>         | The image is compressed in the JPEG format when recorded. Since the compression rate of <b>STD</b> (Standard) is higher than that of <b>FINE</b> (Fine), the file size of <b>STD</b> is smaller than that of <b>FINE</b> . This will allow more files to be recorded on one memory card, but the image quality will be lower.                                  |

## **Notes**

- This item cannot be set when the exposure mode is set to Sweep Panorama.
- For details on the number of images that can be taken when the image quality is changed, see page 32.

## **About RAW images**

You need the “Image Data Converter SR” software included on the CD-ROM (supplied) in order to open a RAW image recorded on this camera. With this software, a RAW image can be opened and converted to a common format, such as JPEG or TIFF, and its white balance, color saturation, contrast, etc., can be readjusted.

- The RAW format image cannot be printed using a DPOF (print) designated printer.
- You cannot set [Auto HDR] on RAW format images.

# Setting the method for recording on a memory card

Selecting the method for assigning file numbers to images

**MENU button** →  **1** → **[File Number]** → **Select the desired setting**

|               |   |
|---------------|---|
| <b>Series</b> | The camera does not reset numbers and assigns numbers to files in sequence until the number reaches “9999.”   |
| <b>Reset</b>  | The camera resets numbers in the following cases and assigns numbers to files from “0001.” When the recording folder contains a file, a number one higher than the largest number is assigned. <ul style="list-style-type: none"><li>– When the folder format is changed.</li><li>– When all the images in the folder are deleted.</li><li>– When the memory card is replaced.</li><li>– When the memory card is formatted.</li></ul> |

Selecting the folder name format

The recorded still images are stored in automatically-created folders in the DCIM folder of the memory card.

**MENU button** →  **1** → **[Folder Name]** → **Select the desired setting**

|                      |   |
|----------------------|---|
| <b>Standard Form</b> | The folder name format is as follows: folder number + MSDCF.<br>Example: 100MSDCF   |
| <b>Date Form</b>     | The folder name format is as follows: folder number + Y (the last digit)/MM/DD.<br>Example: 10000405 (Folder name: 100, date: 2010/04/05) |

## Note

- The movie folder form is fixed as “folder number + ANV01.”

## Creating a new folder

You can create a folder in a memory card for recording images. A new folder is created with a number incremented one higher than the largest number currently used, and the folder becomes the current recording folder. A folder for still images and a folder for movies are created at the same time.

**MENU button** →  **1** → **[New Folder]**

### Notes

- When you insert a memory card that was used with other equipment into the camera and shoot images, a new folder may be automatically created.
- Up to 4 000 images can be stored in a folder. When the folder capacity is exceeded, a new folder is created automatically.

## Selecting the recording folder

When a standard form folder is selected and there are two or more folders, you can select the recording folder to be used to record images.

**MENU button** →  **1** → **[Select REC Folder]** → **Select the desired folder**

### Notes

- You cannot select the folder when you select the setting [Date Form].
- You cannot select the folder for movies.

## Formatting the memory card

Note that formatting irrevocably erases all data on a memory card, including protected images.

**MENU button** →  **1** → **[Format]** → **[Enter]**

### Notes

- During the format, the access lamp lights up. Do not eject the memory card while the lamp is lit.
- Format the memory card using the camera. If you format it on a computer, the memory card may not be usable with the camera, depending on the format type used.
- Formatting may take several minutes depending on the memory card.

## Recovering image database

When inconsistencies are found in the image database file of movies, caused by processing movies on computers, etc., movies on the memory card will not be played back in this form. If this happens, the camera repairs the file.

**MENU button** →  **1** → **[Recover Image DB]** → **[Enter]**

### Note

- Use a sufficiently charged battery. Low battery power during repairing can cause damage to data.

## Checking the remaining space of the card

Displays the remaining recording time of movies and the number of recordable still images on the memory card.





**MENU button** →  **1** → **[Display Card Space]**

## Setting the upload function for an Eye-Fi card



Sets whether or not you use the upload function when using an Eye-Fi card (commercially available). This item appears when an Eye-Fi card is inserted in the camera.

**MENU button** →  **2** → **[Upload Settings]** → **Select the desired setting**

### The status indicators in communication

|   |                                    |
|---|------------------------------------|
|  | Standby. No images are to be sent. |
|  | Upload standby.                    |
|  | Connecting.                        |
|  | Uploading.                         |
|  | Error                              |

## Notes

- Before using an Eye-Fi card, set up the wireless LAN access point and forwarding destination. For details, refer to the operating manual supplied with the Eye-Fi card.
- Eye-Fi cards are sold in the U.S.A, Canada, Japan, and some countries in the EU (as of March in 2010).
- For more information, please contact the manufacturer or vendor directly.
- Eye-Fi cards can be used only in the countries/regions where they were purchased. Use Eye-Fi cards in accordance with the law of the countries/regions where you purchased the card.
- Eye-Fi cards include a wireless LAN function. Do not insert any Eye-Fi cards in the camera when it is prohibited to do so, such as on an airplane. If there is an Eye-Fi card inserted in the camera, set [Upload Settings] to [Off].  OFF is displayed on the screen when [Upload Settings] is set to [Off].
- When you use a brand-new Eye-Fi card for the first time, copy the install file of Eye-Fi manager recorded on the card to your computer before formatting the card.
- Use an Eye-Fi card after updating the firmware to the latest version. For details, refer to the manual that comes with the Eye-Fi card.
- The power save function of the camera does not work while it is uploading images.
- If  (error) is displayed, remove the memory card and reinsert it, or turn off then turn on the power again. If  appears again, the Eye-Fi card may be damaged.
- Wi-Fi network communication may be influenced by other communication devices. If the communication status is poor, move closer to the access point of the Wi-Fi network.
- For details on the file types that can be uploaded, refer to the operating instructions supplied with the Eye-Fi card.
- If you upload an image that was recorded with [GPS On/Off] set to [On], the location information of the image may be made available to a third party. To prevent this, set [GPS On/Off] to [Off] (page 138) (SLT-A55V only).
- This product does not support the Eye-Fi “Endless Memory Mode.” Make sure that Eye-Fi cards that you insert into this product have “Endless Memory Mode” turned off.



# Changing the noise reduction setting

## Disabling the noise reduction during long exposure shootings

When you set the shutter speed to a second or longer (Long exposure shooting), noise reduction is turned on for the same duration that the shutter is open.

This is to reduce the grainy noise typical in a long exposure. When noise reduction is in progress, a message appears and you cannot take another picture. Select [On] to prioritize the image quality. Select [Off] to prioritize the timing of shooting.

**MENU button** →  **3** → [Long Exposure NR] → [Off]

### Notes

- When the exposure mode is set to Sweep Panorama, Continuous Advance Priority AE, or continuous shooting, continuous bracketing, [Hand-held Twilight] in Scene Selection, or ISO is set to [Multi Frame NR], noise reduction is not performed even when it is set to [On].
- When the exposure mode is set to AUTO, AUTO+ or Scene Selection, you cannot turn off noise reduction.

## Setting the noise reduction at high ISO sensitivity settings

The camera reduces the noise that becomes more noticeable when the camera sensitivity is high.

Select [Auto] to prioritize the image quality. Select [Weak] to prioritize the timing of shooting.

**MENU button** →  **3** → [High ISO NR] → **Select the desired setting**

### Notes

- [Weak] is selected automatically for continuous shooting or continuous bracketing images, even when you set it to [Auto].
- When the exposure mode is set to AUTO, AUTO+, Sweep Panorama, or Scene Selection, this item is set to [Weak].
- Noise reduction is not performed on RAW images.

# Changing the function of the buttons

## Changing the operation of the AEL button

The function of the AEL button can be selected from the following two functions:

- Holding the locked exposure value by pressing the AEL button while the button is held down ([AEL hold]).
- Holding the locked exposure value by pressing the AEL button until the button is pressed again ([AEL toggle]).

**MENU button** →  **1** → [AEL button] → **Select the desired setting**

### Notes

- While the exposure value is locked,  appears on the LCD monitor and in the viewfinder. Be careful not to reset the setting.
- The [AEL hold] and [AEL toggle] settings affect the manual shift (page 78) in the manual exposure mode.
- When [AEL toggle] is selected, be sure to press the AEL button again to release the lock.

## Changing the function of a focus hold button to the preview function

If you use a lens equipped with a focus hold button, you can change the function of the button to preview a shot.

**MENU button** →  **1** → [Focus Hold Button] → [D.O.F.Preview]

## Enabling the Focus Magnifier function

You can zoom the image to check the focus using the  button during shooting.

**MENU button** →  **1** → [Focus Magnifier] → [On]

# Changing other settings

## Setting the sound on/off

Selects the sound produced when the shutter is locked, during self-timer countdown, etc.

**MENU button** →  **2** → **[Audio signals]** → **Select the desired setting**

## Removing the Help Guide from the screen

You can turn off the Help Guide that is displayed when you operate the camera. This is convenient when you want to perform the next operation quickly.

**MENU button** →  **1** → **[Help Guide Display]** → **[Off]**

## Setting the time to turn the camera to the power save mode

You can set different time intervals for the camera to switch to power save mode (Power Save). Pressing the shutter button halfway down returns the camera to the shooting mode.

**MENU button** →  **1** → **[Power Save]** → **Select the desired time**

### Note

- Regardless of the setting here, the camera turns to power save mode after 30 minutes when the camera is connected to a TV or the drive mode is set to [Remote Cdr.].

## Releasing the shutter when no lens is attached

You can release the shutter when no lens is attached. Select this when you attach the camera on an astronomical telescope, etc.

**MENU button** →  **1** → **[Release w/oLens]** → **[Enable]**

## Note

- Correct metering cannot be achieved when you use lenses that do not provide a lens contact, such as the lens of an astronomical telescope. In such cases, adjust the exposure manually by checking it on the recorded image.

## Selecting the language

**MENU button** →  **1** → [ **Language**] → **Select the language**

## Setting the demonstration playback of a movie

You can set the camera to start the demonstration playback of a movie if you do not operate the camera for about one minute.

**MENU button** →  **2** → [**Demo Mode**] → [**On**]

# Setting the LCD monitor/electronic viewfinder

## Setting the brightness of the LCD monitor

The brightness of the LCD monitor is automatically adjusted to the surrounding lighting conditions using the light sensor (page 15). You can set the brightness of the LCD monitor manually or select the setting that is suitable for outdoors on a sunny day.

**MENU button** →  **1** → **[LCD Brightness]** → **Select the desired setting**

### Notes

- When it is set to [Auto], do not cover the light sensor with your hand and so on.
- When using the camera with the AC-PW20 AC Adaptor (sold separately), the brightness of the LCD monitor is always set to the brightest setting even if you select [Auto].
- Set it to [Auto] or [Manual] for interior photography because [Sunny Weather] is too bright.

## Setting the brightness of the viewfinder manually

The brightness of the viewfinder is automatically adjusted to the lighting conditions of the subject. You can set the brightness of the viewfinder manually.

**MENU button** →  **1** → **[Viewfinder Bright.]** → **[Manual]** → **Select the desired setting**

### Note

- When using the camera with the AC-PW20 AC Adaptor (sold separately), the brightness of the viewfinder is always set to the brightest setting even if you select [Auto].

## Setting the displayed time of the image right after shooting (Auto review)

You can check the recorded image on the screen right after the shooting. You can change the displayed time.

**MENU button** →  **2** → **[Auto Review]** → **Select the desired setting**

### Note

- In auto review, the image will not be displayed in the vertical position even if [Playback Display] is set to [Auto Rotate] (page 121).

## Setting the method used to switch the LCD monitor and the viewfinder

You can disable the automatic switching of the LCD monitor and the viewfinder and enable only the FINDER/LCD button to switch them.

**MENU button** →  **1** → **[FINDER/LCD Setting]** → **[Manual]**

## Setting the grid line

The grid line is an auxiliary line for shooting composition. You can set the grid line to on/off or select the type of grid line. The available range of movie recording is also displayed.

**MENU button** →  **2** → **[Grid Line]** → **Select the desired setting**

# Confirming the version of the camera

Displays the version of your camera. Confirm the version when a firmware update is released.

**MENU button** →  **2** → [Version]

## Note

- An update can be performed only when the battery level is  (three remaining battery icons) or more. We recommend that you use a sufficient battery or the AC-PW20 AC Adaptor (sold separately).

# Resetting to the default

You can reset the main functions of the camera.

**MENU button** →  2 → **[Reset Default]** → **[Enter]**

The items to be reset are as follows.

| Items                              | Reset to  |
|------------------------------------|---|
| Exposure compensation (101)        | ±0.0  |
| Recording information display (40) | Graphic Display   |
| Playback display (121)             | Single-image screen (with recording information)                        |
| Drive mode (116)                   | Single-shot Adv.  |
| Flash Mode (96)                    | Fill-flash (differs based on whether the built-in flash is open or not) |
| Autofocus Mode (88)                | AF-A  |
| AF area (89)                       | Wide  |
| Face Detection (93)                | On  |
| Smile Shutter (94)                 | Off   |
| ISO (106)                          | AUTO  |
| Metering Mode (105)                | Multi segment   |
| Flash Compensation (103)           | ±0.0  |
| White Balance (112)                | AWB (Auto white balance)  |
| Color Temp./Color Filter (113)     | 5500K, Color Filter 0   |
| Custom white balance (114)         | 5500K   |
| DRO/Auto HDR (107)                 | D-Range Optimizer: Auto   |
| Creative Style (110)               | Standard  |
| Scene Selection (63)               | Portrait  |

## Recording menu

| Items                     | Reset to                                 |
|---------------------------|--|
| Image: Size (141)         | L:16M (SLT-A55/A55V)/<br>L:14M (SLT-A33) |
| Image: Aspect Ratio (143) | 3:2                                      |
| Image: Quality (143)      | Fine                                     |
| Movie: Size (142)         | 1920 × 1080                              |



| Items                     | Reset to  |
|---------------------------|-----------|
| Movie: File Format (82)   | AVCHD     |
| Movie: Audio Rec. (82)    | On        |
| SteadyShot (57)           | On        |
| Panorama: Size (142)      | Standard  |
| Panorama: Direction (68)  | Right     |
| 3D Pan.: Image Size (142) | 16:9      |
| 3D Pan.: Direction (68)   | Right     |
| Flash control (104)       | ADI flash |
| AF Illuminator (98)       | Auto      |
| Color Space (111)         | sRGB      |
| Long Exposure NR (149)    | On        |
| High ISO NR (149)         | Auto      |

### Custom menu

| Items                     | Reset to      |
|---------------------------|---------------|
| Eye-Start AF (39)         | Off           |
| FINDER/LCD Setting (154)  | Auto          |
| AEL button (150)          | AEL hold      |
| Focus Magnifier (150)     | Off           |
| Focus Hold Button (150)   | Focus Hold    |
| Red Eye Reduction (98)    | Off           |
| Release w/oLens (151)     | Disable       |
| Grid Line (154)           | Off           |
| Histogram (102)           | Off           |
| Display Rec. Data (41)    | For Live View |
| Auto Review (154)         | Off           |
| Auto+ Cont. Advance (62)  | Auto          |
| Auto+ Image Extract. (62) | Auto          |

### Playback menu

| Items                       | Reset to |
|-----------------------------|----------|
| Slide Show – Interval (125) | 3 sec    |
| Slide Show – Repeat (125)   | Off      |

| Items                                 | Reset to    |
|---------------------------------------|-------------|
| Specify Printing – Date Imprint (173) | Off         |
| Volume Settings (122)                 | 2           |
| Playback Display (121)                | Auto Rotate |

### Memory Card Tool menu

| Items             | Reset to      |
|-------------------|---------------|
| File Number (145) | Series        |
| Folder Name (145) | Standard Form |

### Setup menu

| Items  | Reset to     |
|--|--------------|
| LCD Brightness (153)                                       | Auto         |
| Viewfinder Bright. (153)                                   | Auto         |
| GPS Settings – GPS On/Off (138)<br>(SLT-A55V only)         | On           |
| GPS Settings – GPS Auto Time Cor.<br>(140) (SLT-A55V only) | On           |
| Power Save (151)   | 1 Min        |
| CTRL FOR HDMI (136)  | On           |
| Help Guide Display (151)                                   | On           |
| Upload Settings (147)                                      | On           |
| USB Connection (165)                                       | Mass Storage |
| Audio signals (151)  | On           |
| Demo Mode (152)  | Off          |

# Using with your computer

Following applications are contained on the CD-ROM (supplied) to allow more versatile use of images shot with your camera.

- Sony Image Data Suite
  - “Image Data Converter SR”
  - “Image Data Lightbox SR”
- “PMB” (Picture Motion Browser)

## Note

- “PMB” is not compatible with Macintosh computers.

## Recommended computer environment (Windows)

The following computer environment is recommended when using the supplied software and importing images via a USB connection.

|   |  |
|---|--|
| <b>OS (pre-installed)</b>   | Microsoft Windows XP <sup>*1</sup> SP3/Windows Vista <sup>*2</sup> SP2/Windows 7   |
| <b>“PMB”</b>  | <b>CPU:</b> Intel Pentium III 800 MHz or faster<br>(For playing/editing the High Definition movies: Intel Core Duo 1.66 GHz or faster/Intel Core 2 Duo 1.66 GHz or faster)<br><b>Memory:</b> 512 MB or more (For playing/editing the High Definition movies: 1 GB or more)<br><b>Hard Disk:</b> Disk space required for installation-approximately 500 MB<br><b>Display:</b> Screen resolution-1024 × 768 dots or more |
| <b>“Image Data Converter SR Ver.3”</b><br><b>“Image Data Lightbox SR”</b> | <b>CPU/Memory:</b> Pentium 4 or faster/1 GB or more<br><b>Display:</b> 1024 × 768 dots or more   |

\*1 64-bit editions and Starter (Edition) are not supported. Windows Image Mastering API (IMAPI) Ver.2.0 or later is required to use the function for creating discs.

\*2 Starter (Edition) is not supported.

## Recommended computer environment (Macintosh)

The following computer environment is recommended when using the supplied software and importing images via a USB connection.

|   |  |
|---|--|
| <b>OS (pre-installed)</b>   | <b>USB Connection:</b> Mac OS X (v10.3, 10.4, 10.5, 10.6)<br><b>“Image Data Converter SR Ver.3”/“Image Data Lightbox SR”:</b> Mac OS X (v10.4, 10.5, 10.6 (Snow Leopard))                                    |
| <b>“Image Data Converter SR Ver.3”<br/>“Image Data Lightbox SR”</b> | <b>CPU:</b> Power PC G4/G5 series (1.0 GHz or faster is recommended)/Intel Core Solo/Core Duo/Core 2 Duo or faster<br><b>Memory:</b> 1 GB or more is recommended.<br><b>Display:</b> 1024 × 768 dots or more |

### Notes

- Operation is not assured in an environment based on an upgrade of the operating systems described above or in a multi-boot environment.
- If you connect two or more USB devices to a single computer at the same time, some devices, including the camera, may not operate, depending on the types of USB devices you are using.
- Connecting the camera using a USB interface that is compatible with Hi-Speed USB (USB 2.0 compliant) allows advanced transfer (high speed transfer), as the camera is compatible with Hi-Speed USB (USB 2.0 compliant).
- When your computer resumes activity from suspend or sleep mode, communication between the camera and your computer may not recover at the same time.

# Using the software

## Installing the software (Windows)

Log on as Administrator.

### 1 Turn on your computer, and insert the CD-ROM (supplied) into the CD-ROM drive.

The installation menu screen appears.

- If it does not appear, double-click [Computer] (For Windows XP: [My Computer]) →  (SONYPMB) → [Install.exe].
- If the AutoPlay screen appears, select “Run Install.exe” and follow the instructions that appear on the screen to proceed with the installation.

### 2 Click [Install].

Make sure that both “Sony Image Data Suite” and “PMB” are checked and follow the instructions on the screen.

- Connect the camera to the computer during the procedure following the instructions on the screen (page 165).
- When the restarting confirmation message appears, restart the computer following the instructions on the screen.
- DirectX may be installed depending on the system environment of your computer.

### 3 Remove the CD-ROM after the installation is complete.

The following software is installed and shortcut icons appear on the desktop.

- “Image Data Converter SR”
- “Image Data Lightbox SR”
- “PMB”
- “PMB Launcher”
- “PMB Help”

#### Notes

- If “PMB” has already been installed on the computer, and the version number of the previously installed “PMB” is lower than that of the “PMB” on the CD-ROM (supplied), install “PMB” also from the CD-ROM (supplied).

- If “PMB” has already been installed on the computer, and the version of the previously installed “PMB” is higher than that of the “PMB” on the CD-ROM (supplied), installation is not required. The usable functions are activated when the camera is connected to the computer using the USB cable.
- If a version of “PMB” under 5.0.00 has been installed on your computer, you may be unable to use some functions of those “PMB” when installing the “PMB” from the supplied CD-ROM. Also, “PMB Launcher” is installed from the supplied CD-ROM and you can start “PMB” or other software by using the “PMB Launcher.” Double-click the “PMB Launcher” short-cut icon on the computer screen to start “PMB Launcher.”

## Installing the software (Macintosh)

Log on as Administrator.

---

**1 Turn on your Macintosh computer, and insert the CD-ROM (supplied) into the CD-ROM drive.**

---

**2 Double-click the CD-ROM icon.**

---

**3 Copy the [IDS\_INST.pkg] file in the [MAC] folder to the hard disk icon.**

---

**4 Double-click the [IDS\_INST.pkg] file in the copy-to folder.**

Follow the instructions on the screen to complete the installation.

## Using “Image Data Converter SR”

With “Image Data Converter SR” you can do the following, etc.:

- To edit images recorded in RAW format with various corrections, such as tone curve, and sharpness.
- To adjust images with white balance, exposure, and creative style, etc.
- To save the images displayed and edited on a computer.
- You can either save the image as RAW format or save it in the general file format.

To use “Image Data Converter SR,” refer to Help.

Click [Start] → [All Programs] → [Sony Image Data Suite] → [Help] → [Image Data Converter SR Ver.3].

“Image Data Converter SR” support page (English only)

<http://www.sony.co.jp/ids-se/>

## Using “Image Data Lightbox SR”

With “Image Data Lightbox SR” you can do the following, etc.:

- To display and compare RAW/JPEG images recorded with this camera.
- To rate the images on a scale of five.
- To set color labels and so on.
- To display an image with “Image Data Converter SR” and make adjustments to it.

To use “Image Data Lightbox SR,” refer to Help.

Click [Start] → [All Programs] → [Sony Image Data Suite] → [Help] → [Image Data Lightbox SR].

“Image Data Lightbox SR” support page (English only)

<http://www.sony.co.jp/ids-se/>

## Using “PMB”

With “PMB” you can do the following, etc.:

- To set images shot with the camera and display them on the computer.
- To organize images on the computer on a calendar by shooting date to view them.
- To retouch (red-eye reduction, etc.), print, and send still images as e-mail attachments, change the shooting date.
- To display the shooting location of the image on the map (SLT-A55V only).
- To print or save still images with the date.
- To create Blu-ray discs, AVCHD format discs or DVD discs from AVCHD format movies imported to a computer. (An internet connection

environment is required when a Blu-ray disc/DVD disc is created for the first time.)

### Notes

- “PMB” is not compatible with Macintosh computers.
- The confirmation message of the Information tool appears on the screen when starting “PMB” for the first time. Select [Start]. This function informs you of news, such as software updates. You can change the setting later.

To use “PMB,” refer to “PMB Help.”

Double-click the shortcut of  (PMB Help) on the desktop. Or, click [Start] → [All Programs] → [PMB] → [PMB Help].

“PMB” support page (English only)

<http://www.sony.co.jp/pmb-se/>



# Connecting the camera to the computer

**1** Insert a sufficiently charged battery pack into the camera, or connect the camera to a wall outlet (wall socket) using the AC-PW20 AC Adaptor (sold separately).

**2** Turn on the computer, then press the  (Playback) button.

**3** Check that [USB Connection] in  2 is set to [Mass Storage].

**4** Connect the camera to your computer.

- When a USB connection is established for the first time, your computer automatically runs a program to recognize the camera. Wait for a while.

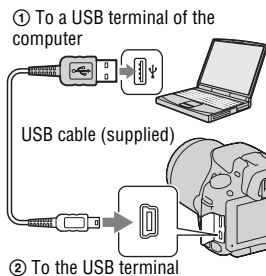

## Importing images to the computer (Windows)

“PMB” allows you to easily import images.

For details on “PMB” functions, see the “PMB Help.”

### Importing images to the computer without using “PMB”

When the AutoPlay Wizard appears after making a USB connection between the camera and a computer, click [Open folder to view files] → [OK] → [DCIM] or [MP\_ROOT] → copy the desired images to the computer.

## File name

| Folder         | The type of file       | File name    |
|----------------|------------------------|--------------|
| DCIM folder    | JPEG file              | DSC0□□□□.JPG |
|                | JPEG file (Adobe RGB)  | _DSC□□□□.JPG |
|                | RAW file               | DSC0□□□□.ARW |
|                | RAW file (Adobe RGB)   | _DSC□□□□.ARW |
| MP_ROOT folder | MP4 file (1440 × 1080) | MAH0□□□□.MP4 |
|                | MP4 file (VGA)         | MAQ0□□□□.MP4 |

- □□□□ (file number) stands for any number within the range of 0001 to 9999.
- When [Image: Quality] is set to [RAW & JPEG], the numerical portions of the name of a RAW data file and its corresponding JPEG file are the same.

### Notes

- For operations such as importing AVCHD movies to the computer, use “PMB.”
- Use “PMB” to import the movies with GPS location information to a computer (SLT-A55V only).
- When the camera is connected to the computer, if you operate AVCHD format movies or folders from the connected computer, images may be damaged or cannot be played. Do not delete or copy AVCHD format movies on the memory card from the computer. Sony is not held liable for consequences resulting from such operations via the computer.

## Importing images to the computer (Macintosh)

**1** Connect the camera to your Macintosh computer first. Double-click the newly recognized icon on the desktop → the folder where the images you want to import are stored.

**2** Drag and drop the image files to the hard disk icon.

The image files are copied to the hard disk.

---

### 3 Double-click the hard disk icon → the desired image file in the folder containing the copied files.

The image is displayed.

---

#### Note

- Use “iMovie” bundled with a Macintosh computer to import or operate AVCHD format movies.

## Deleting the USB connection

Perform the procedures from step 1 to 3 below before:

- Disconnecting the USB cable.
  - Removing the memory card.
  - Turning off the camera.
- 

### 1 Double-click the disconnect icon on the taskbar.

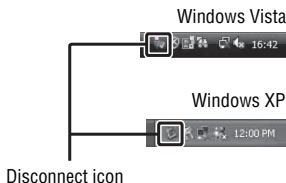

---

### 2 Click (USB Mass Storage Device) → [Stop].

---

### 3 Confirm the device on the confirmation window, then click [OK].

---

#### Note

- Drag and drop the icon of the memory card or the drive icon to the “Trash” icon beforehand when you use a Macintosh computer, and the camera is disconnected from the computer.

# Creating a movie disc



You can create a disc from AVCHD format movies recorded on the camera.

## Selecting the method for creating a disc

Select the method that best suits your disc player.

See “PMB Help” for details on creating a disc using “PMB.”

To import movies, see page 165.

| Player  | Method   | Disc type   |
|---|--|---|
| <b>Blu-ray disc playback devices</b><br>(Blu-ray disc player, PlayStation®3, etc.)      | Create a Blu-ray disc of movies and photos imported to a computer using “PMB.”                                 | <b>Blu-ray</b><br> |
| <b>AVCHD format playback devices</b><br>(Sony Blu-ray disc player, PlayStation®3, etc.) | Create an AVCHD format disc of movies and photos imported to a computer using “PMB.”                           | <b>AVCHD</b><br>   |
|   | Creating an AVCHD format disc with a DVD writer/recorder other than DVDirect Express.                          |   |
| <b>Ordinary DVD playback devices</b><br>(DVD player, DVD playable computer, etc.)       | Create a standard definition image quality (STD) disc of movies and photos imported to a computer using “PMB.” | <b>STD</b><br>     |



### Notes

- If you use a Sony DVDirect (DVD Writer), you can transfer data by inserting a memory card into the memory card slot of the DVD writer, or connecting your camera to the DVD writer with a USB cable.
- When you use Sony DVDirect (DVD writer), make sure that the version of DVD writer's firmware is the latest.

For details, refer to the following URL:

<http://sony.storagesupport.com/>

## Characteristics of each type of disc

|  |   |
|--|---|
| A Blu-ray disc enables you to record high definition image quality (HD) movies of a longer duration than DVD discs.  |  |
| High definition image quality (HD) movie can be recorded on DVD media, such as DVD-R discs, and a high definition image quality (HD) disc is created. <ul style="list-style-type: none"><li>You can play a high definition image quality (HD) disc on AVCHD format playback devices, such as a Sony Blu-ray disc player and a PlayStation®3. You cannot play the disc on ordinary DVD players.</li></ul> |  |
| Standard definition image quality (STD) movie converted from high definition image quality (HD) movie can be recorded on DVD media, such as DVD-R discs, and a standard image quality (STD) disc is created.   |  |

### Discs you can use with “PMB”

You can use 12 cm discs of following type with “PMB.” For Blu-ray disc, see page 170.

| Disc type            | Features     |
|----------------------|--------------|
| DVD-R/DVD+R/DVD+R DL | Unrewritable |
| DVD-RW/DVD+RW        | Rewritable   |

- Always maintain your PlayStation®3 to use the latest version of the PlayStation®3 system software.
- The PlayStation®3 may not be available in some countries/regions.

### Creating an AVCHD format disc

You can create a high definition image quality (HD) AVCHD format disc from AVCHD format movies imported to a computer using the supplied software “PMB.”

**1** Select the AVCHD format movies you want to write on “PMB.”

**2** Click  (Create Discs) to select [Create AVCHD Format Discs (HD)].

The screen used for creating a disc appears.

- For details, see “PMB Help.”

## Notes

- Install “PMB” beforehand.
- Still images and MP4 movie files cannot be recorded on the AVCHD format disc.
- It may take a long time to create a disc.

## Playing AVCHD format disc on a computer

You can play back AVCHD format discs using “Player for AVCHD” that is installed together with “PMB.”

To start the software, click on [Start] → [All Programs] → [PMB] → [PMB Launcher] → [View] → [Player for AVCHD].

For detailed operations, see the Help for “Player for AVCHD.”

## Note

- Movies may not be played smoothly depending on the computer environment.

## Creating a Blu-ray disc

You can create a Blu-ray disc with AVCHD movies previously imported to a computer. Your computer must support the creation of Blu-ray discs. BD-R (non-rewritable) and BD-RE (rewritable) media can be used to create Blu-ray discs. You cannot add contents to either type of disc once it has been created.

Click [BD Add-on Software] on the installation screen of “PMB,” and install this plug-in according to the on-screen instructions.

Connect your computer to the Internet when you install [BD Add-on Software].

See “PMB Help” for details.

## Creating a standard definition image quality (STD) disc

You can create a standard definition image quality (STD) disc from AVCHD format movies imported to a computer using supplied software “PMB.”

---

### 1 Select the AVCHD format movies you want to write on “PMB.”

---

### 2 Click (Create Discs) to select [Create DVD-Video Format Discs (STD)].

The screen used for creating a disc appears.

- For details, see “PMB Help.”

---

#### Notes

- Install “PMB” beforehand.
- MP4 movie files cannot be recorded on a disc.
- It will take a longer time to create a disc because AVCHD format movies are converted to standard definition image quality (STD) movies.
- An Internet connection environment is required when creating a DVD-Video (STD) disc for the first time.

# Specifying DPOF

Using the camera, you can specify the still images and the number of images to print before you print images at a shop or with your printer. Follow the procedure below.

DPOF specifications are left with images after printing. It is recommended that you unspecify them after printing.

## Specifying /unspecifying DPOF on selected images

---

**1 MENU button** →  **1** → **[Specify Printing]** → **[DPOF Setup]**  
→ **[Multiple Img.]**

---

**2 Select the image with**   **on the control button.**

---

**3 Select the number of sheets with the center of the control button.**

- To unspecify DPOF, set the number to “0.”
- 

**4 Press the MENU button.**

---

**5 Select [Enter] with**  **, then press the center of the control button.**

---

### Notes

- You cannot specify DPOF on RAW data files.
- You can specify any number up to 9.



## Dating images

You can date images when printing them. The position of the date (inside or outside the image, character size, etc.) depends on your printer.

**MENU button** →  **1** → **[Specify Printing]** → **[Date Imprint]** → **[On]**

### Note

- This function may not be provided, depending on the printer.

# Specifications

## Camera

### [System]

Camera Type

Interchangeable Lens  
Digital Camera

Lens

A-mount lens

### [Image sensor]

Image format

**SLT-A55/A55V**  
23.5×15.6 mm (APS-C  
format) CMOS image  
sensor  
**SLT-A33**  
23.4×15.6 mm (APS-C  
format) CMOS image  
sensor

Total pixel number of image sensor

**SLT-A55/A55V**  
Approx. 16 700 000 pixels  
**SLT-A33**  
Approx. 14 600 000 pixels

Effective pixel number of camera

**SLT-A55/A55V**  
Approx. 16 200 000 pixels  
**SLT-A33**  
Approx. 14 200 000 pixels

### [SteadyShot]

System

Image sensor-shift  
mechanism

Effect

Approx. 2.5 to 4 EV in  
shutter speed (depending  
on shooting conditions and  
the attached lens)

### [Anti-Dust]

System

Charge protection coating  
on Low-Pass Filter and

image sensor-shift  
mechanism

### [Auto focus system]

System

TTL phase-detection  
system, 15 points (3 points  
cross type)

Sensitivity Range

-1 to 18 EV (at ISO 100  
equivalent)

AF illuminator

Approx. 1 to 5 m (3.3 to  
16.4 feet)

### [Live View]

Type

Main sensor Live View  
(Translucent mirror  
mechanism)

Image format

“Exmor” CMOS sensor

Frame coverage

100%

### [Electronic viewfinder]

Type

Electronic viewfinder  
(color)

Screen size

1.2 cm (0.46 type)

Total number of dots

1 440 000 dots conversion

Available screen size displayed

1.1 cm (0.43 type)

Available number of dots displayed

1 152 000 dots conversion

Frame coverage

100%

Magnification

1.10 × with 50 mm lens at  
infinity, -1 m<sup>-1</sup> (diopter)

Eye Point

Approximately 19 mm  
from the eyepiece, 18 mm  
from the eyepiece frame at  
-1 m<sup>-1</sup>

Diopter Adjustment  
-4.0 to +4.0 m<sup>-1</sup> (diopter)

### [LCD monitor]

LCD panel 7.5 cm (3.0 type) TFT  
drive

Total number of dots  
921 600 (640 × 3 (RGB) ×  
480) dots

### [Exposure control]

Metering Cell  
“Exmor” CMOS sensor

Metering method  
1200-zone evaluative  
metering

Metering Range  
-2 to +17 EV on Multi  
segment, Center weighted,  
Spot modes (at ISO 100  
equivalent with F1.4 lens)

ISO sensitivity (Recommended  
exposure index)  
AUTO, ISO 100 to 12800

Exposure compensation  
±2.0 EV (1/3 EV step)

### [Shutter]

Type Electronically-controlled,  
vertical-traverse, focal-  
plane type

Speed range 1/4000 second to 30  
seconds, bulb, (1/3 EV  
step)

Flash sync speed  
1/160 second

### [Built-In-Flash]

Flash G.No.  
GN 10 (in meters at ISO  
100)

Recycling time  
Approx. 4 seconds

Flash coverage  
Covering 18 mm lens  
(focal length that the lens  
indicates)

Flash compensation  
±2.0 EV (1/3 EV step)

### [Recording format]

File format JPEG (DCF Ver. 2.0, Exif  
Ver. 2.3, MPF Baseline)  
compliant, DPOF  
compatible

Movie (AVCHD format)  
AVCHD Ver. 1.0  
compliant  
Video: MPEG-4 AVC/  
H.264  
Audio: Dolby Digital 2ch,  
equipped with Dolby  
Digital Stereo Creator

- Manufactured under  
license from Dolby  
Laboratories.

Movie (MP4 format)  
Video: MPEG-4 AVC/  
H.264  
Audio: MPEG-4 AAC-LC  
2ch

### [Recording media]

“Memory Stick PRO Duo”  
media, SD card

### [Input/output terminals]

USB miniB

HDMI HDMI type C minijack

Mic Terminal  
Ø 3.5 mm Stereo minijack

REMOTE Terminal

### [Power, general]

Used battery pack  
Rechargeable battery pack  
NP-FW50

## [Others]

|                          |   |
|--------------------------|---|
| Exif Print               | Compatible  |
| PRINT Image Matching III | Compatible  |
| Dimensions               | Approx. 124.4 × 92 × 84.7 mm (4 7/8 × 3 5/8 × 3 1/3 inches) (W/H/D, excluding protrusions)  |
| Mass                     | <b>SLT-A55V</b><br>Approx. 500 g (1 lb 1.6 oz) (with battery and “Memory Stick PRO Duo” media)<br>Approx. 441 g (15.6 oz) (body only)<br><b>SLT-A55/A33</b><br>Approx. 492 g (1 lb 1.3 oz) (with battery and “Memory Stick PRO Duo” media)<br>Approx. 433 g (15.3 oz) (body only) |
| Operating temperature    | 0 to 40°C (32 to 104°F)   |
| USB communication        | Hi-Speed USB (USB 2.0 compliant)  |

## BC-VW1 Battery charger

|                             |   |
|-----------------------------|---|
| Input rating                | 100 V - 240 V AC, 50 Hz/60 Hz, 4.2 W                            |
| Output rating               | 8.4 V DC, 0.28 A  |
| Operating temperature range | 0 to 40°C (32 to 104°F)   |
| Storage temperature range   | -20 to +60°C (-4 to +140°F)                                     |
| Maximum dimensions          | Approx. 63 × 95 × 32 mm (2 1/2 × 3 3/4 × 1 5/16 inches) (W/H/D) |
| Mass                        | Approx. 85 g (3 oz)   |

## Rechargeable battery pack NP-FW50

|                        |   |
|------------------------|---|
| Used battery           | Lithium-ion battery   |
| Maximum voltage        | DC 8.4 V  |
| Nominal voltage        | DC 7.2 V  |
| Maximum charge voltage | DC 8.4 V  |
| Maximum charge current | 1.02 A  |
| Capacity               | Typical 7.7 Wh (1 080 mAh)<br>Minimum 7.3 Wh (1 020 mAh)            |
| Maximum dimensions     | Approx. 31.8 × 18.5 × 45 mm (1 5/16 × 3/4 × 1 13/16 inches) (W/H/D) |
| Mass                   | Approx. 57 g (2.1 oz)   |

Design and specifications are subject to change without notice.

## On focal length

The picture angle of this camera is narrower than that of a 35 mm-format film camera. You can find the approximate equivalent of the focal length of a 35 mm-format film camera, and shoot with the same picture angle, by increasing the focal length of your lens by half. For example, by using a 50 mm lens, you can get the approximate equivalent of a 75 mm lens of a 35 mm-format film camera.

## On image data compatibility

- This camera conforms with DCF (Design rule for Camera File system) universal standard established by JEITA (Japan Electronics and Information Technology Industries Association).
- Playback of images recorded with your camera on other equipment and playback of images recorded or edited with other equipment on your camera are not guaranteed.

## Trademarks

- **α** is a trademark of Sony Corporation.
- “Memory Stick,” , “Memory Stick PRO,” **MEMORY STICK PRO**, “Memory Stick Duo,” **MEMORY STICK DUO**, “Memory Stick PRO Duo,” **MEMORY STICK PRO DUO**, “Memory Stick PRO-HG Duo,” **MEMORY STICK PRO-HG DUO**, “Memory Stick Micro,” “MagicGate,” and **MAGICGATE** are trademarks of Sony Corporation.
- “InfoLITHIUM” is a trademark of Sony Corporation.
- “PhotoTV HD” is a trademark of Sony Corporation.
- “AVCHD” and “AVCHD” logotype are trademarks of Panasonic Corporation and Sony Corporation.
- “Blu-ray Disc” and the logo are trademarks.
- Dolby and the double-D symbol are trademarks of Dolby Laboratories.
- Microsoft, Windows, DirectX, and Windows Vista are either registered trademarks or trademarks of Microsoft Corporation in the United States and/or other countries.
- HDMI, the HDMI logo and High-Definition Multimedia Interface are trademarks or registered trademarks of HDMI Licensing LLC.
- Macintosh and Mac OS are trademarks or registered trademarks of Apple Inc.
- PowerPC is a registered trademark of IBM Corporation in the United States.

- Intel, Intel Core, MMX, and Pentium are trademarks or registered trademarks of Intel Corporation.
- SDXC, SDHC Logo are trademarks of SD-3C, LLC.
- Eye-Fi is a trademark of Eye-Fi Inc.
- MultiMediaCard is a trademark of MultiMediaCard Association.
- “PlayStation” is a registered trademark of Sony Computer Entertainment Inc.
- Adobe is a registered trademark or a trademark of Adobe Systems Incorporated in the United States and/or other countries.
- In addition, system and product names used in this manual are, in general, trademarks or registered trademarks of their respective developers or manufacturers. However, the <sup>TM</sup> or ® marks are not used in all cases in this manual.



# Troubleshooting

If you experience trouble with your camera, try the following solutions. Check the items on pages 179 to 188. Consult your Sony dealer or local authorized Sony service facility.

❶ Check the following items.

❷ Remove the battery pack, and insert the battery pack again after about one minute, and turn on the power.

❸ Reset the settings (page 156).

❹ Consult your Sony dealer or local authorized Sony service facility.

## Battery pack and power

### The battery pack cannot be installed.

- As you insert the battery pack, use the tip of the battery pack to push the lock lever (page 20).
- You can use an NP-FW50 battery pack only. Make sure that the battery is NP-FW50.

### The remaining battery indicator is incorrect, or sufficient remaining battery indicator is displayed but the power runs out too quickly.

- This phenomenon occurs when you use the camera in an extremely hot or cold location (page 192).
- The battery pack is discharged. Install a charged battery pack (page 18).
- The battery pack is dead (page 23). Replace it with a new one.

### Cannot turn on the camera.

- Install the battery pack correctly (page 20).
- The battery pack is discharged. Install a charged battery pack (page 18).
- The battery pack is dead (page 23). Replace it with a new one.

---

### **The power turns off suddenly.**

- If you do not operate the camera for given period of time, the camera turns to power saving mode and nearly shuts down. To cancel the power save, operate the camera, such as pressing the shutter button halfway down (page 151).

---

### **The CHARGE lamp flashes when charging the battery pack.**

- You can use an NP-FW50 battery pack only. Make sure that the battery is NP-FW50.
- If you charge a battery pack that has not been used for a long time, the CHARGE lamp may flash.
- The CHARGE lamp flashes in two ways, fast (about 0.15-second intervals) and slow (about 1.5-second intervals). If it is flashing fast, remove the battery pack and reattach the same battery pack securely. If the CHARGE lamp flashes fast again, it suggests that there is something wrong with the battery pack. Slow flashing indicates that charging is suspended because the ambient temperature is outside the suitable range for charging the battery pack. Charging will resume and the CHARGE lamp will be lit when the ambient temperature returns to within the suitable temperature. Charge the battery pack under the suitable temperatures between 10°C and 30°C (50°F and 86°F).

## Shooting images

### **Nothing is displayed on the LCD monitor in viewfinder mode when the power is turned on.**

- If you do not operate the camera for given period of time, the camera turns to power saving mode and nearly shuts down. To cancel the power save, operate the camera, such as pressing the shutter button halfway down (page 151).

---

### **The image is not clear in the viewfinder.**

- Adjust the diopter scale properly using the diopter-adjustment dial (page 29).

---

### **No images in the viewfinder.**

- [FINDER/LCD Setting] is set to [Manual]. Press the FINDER/LCD button (page 39).



---

**The shutter does not release.**

- You are using a memory card with a write-protect switch, and the switch is set to the LOCK position. Set the switch to the recording position.
- Check the free capacity of the memory card (page 32).
- You cannot record images while charging the built-in flash (page 96).
- The shutter cannot be released when the subject is out of focus.
- The lens is not attached properly. Attach the lens properly (page 26).
- When the camera is attached to another device, such as an astronomical telescope, set [Release w/oLens] to [Enable] (page 151).
- The subject may require special focusing (page 86). Use the focus-lock or manual focus function (pages 87, 90).

---

**Recording takes a long time.**

- The noise reduction function is turned on (page 149). This is not a malfunction.
- You are shooting in RAW mode (page 143). Since the RAW data file is large, the RAW mode shooting may take time.
- The Auto HDR is processing an image (page 107).

---

**The same image is shot several times.**

- The drive mode is set to [Continuous adv.] or [Bracket: Cont.]. Set it to [Single-shot Adv.] (page 116).
- The exposure mode is set to Continuous Advance Priority AE (page 69).
- The exposure mode is set to AUTO+ and [Auto+ Image Extract.] is set to [Off] (page 62).

---

**The image is out of focus.**

- The subject is too close. Check the minimum focal distance of the lens.
- You are shooting in manual focus mode, set the focus mode switch to AF (autofocus) (page 85).
- When the focus mode switch is equipped with the lens, set it to AF.
- Ambient light is insufficient.

---

**Eye-Start AF does not work.**

- Set [Eye-Start AF] to [On] (page 39).
- Press the shutter button halfway down.

---

### **The flash does not work.**

- The flash mode is set to [Autoflash]. If you want to make sure the flash fires without fail, set the flash mode to [Fill-flash] (page 96).

---

### **The flash takes too long to recharge.**

- The flash has been fired in succession in a short period. When the flash has been fired in succession, the recharging process may take longer than usual to avoid overheating of the camera.

---

### **A picture taken with the flash is too dark.**

- If the subject is beyond the flash range (the distance that the flash can reach), the pictures will be dark because the flash light does not reach the subject. If the ISO is changed, the flash range also changes with it (page 98).

---

### **The date and time are recorded incorrectly.**

- Set the correct date and time (page 28).
- The area selected with [Area Setting] is different from the actual area. Set up [Area Setting] again (page 28).

---

### **The aperture value and/or shutter speed flashes when you press the shutter button halfway down.**

- Since the subject is too bright or too dark, it is beyond the available range of the camera. Adjust the setting again.

---

### **The image is whitish (Flare).**

### **Blurring of light appears on the image (Ghosting).**

- The picture was taken under a strong light source, and excessive light has entered the lens. Attach a lens hood (sold separately).

---

### **The corners of the picture are too dark.**

- If any filter or hood is used, take it off and try shooting again. Depending on the thickness of the filter and improper attachment of the hood, the filter or the hood may partially appear in the image. The optical properties of some lenses may cause the periphery of the image to appear too dark (insufficient light).

---

**The eyes of the subject come out red.**

- Activate the red eye reduction function (page 98).
- Get close to the subject, and shoot the subject within the flash range using the flash (page 98).

---

**Dots appear and remain on the LCD monitor.**

- This is not a malfunction. These dots are not recorded (page 7).

---

**The image is blurred.**

- The picture was taken in a dark location without the flash, resulting in camera shake. The use of a tripod or the flash is recommended (pages 58, 96).

---

**The EV scale ◀ ▶ is flashing on the LCD monitor or in the viewfinder.**

- The subject is too bright or too dark for the metering range of the camera.

## Viewing images

**Your camera cannot play back images.**

- The folder/file name has been changed on your computer (page 165).
- When an image file has been processed by a computer or when the image file was recorded using a model other than that of your camera, playback on your camera is not guaranteed.
- Use “PMB” to play images stored on a PC with this camera.
- The camera is in USB mode. Delete the USB connection (page 167).

## Deleting/Editing images

**Your camera cannot delete an image.**

- Cancel the protection (page 131).

---

**You have deleted an image by mistake.**

- Once you have deleted an image, you cannot restore it. We recommend that you protect images that you do not want to delete (page 131).

---

**You cannot mark a DPOF mark.**

- You cannot mark DPOF marks on RAW images.

## GPS (SLT-A55V only)

### **The camera is not receiving a GPS signal.**

- Set [GPS On/Off] to [On] (page 138).
- Your camera may not be able to receive radio signals from GPS satellites because of obstructions.
- To triangulate the location information correctly, bring your camera to an open area, and turn on the camera again.

---

### **Excessive error in location information.**

- The margin of error can be up to several-hundred meters depending on surrounding buildings, weak GPS signals, etc.
- When your camera cannot receive a GPS signal, previously-triangulated location information is used in the present location instead. If you move a long distance, incorrect location information may be recorded. Check the triangulation status with the GPS indicator displayed on the screen during shooting (page 138).

---

### **It takes time to triangulate although GPS assist data has been taken in.**

- [Date/Time Setup] is not set, or set time is shifted greatly. Set the date and time correctly (page 28).
- The term of validity of assist data has expired. Update the GPS assist data (page 139).
- As the positions of GPS satellites vary constantly, it may take longer to determine the location or the receiver may not be able to determine the location at all, depending on the location and time you use the camera.
- “GPS” is a system for determining geographic location by triangulating radio signals from GPS satellites. Avoid using the camera in places where radio signals are blocked or reflected, such as a shadowy place surrounded by buildings or trees, etc. Use the camera in open sky environments.

---

### **The location information has not been recorded.**

- Use “PMB” to import the movies with GPS location information to your computer.

## Computers

### **You do not know if the OS of your computer is compatible with the camera.**

- Check “Using with your computer” (page 159).

---

### **Your computer does not recognize your camera.**

- Check that the camera is turned on.
- When the battery level is low, install the charged battery pack (page 18), or use the AC Adaptor (sold separately).
- Use the USB cable (supplied) (page 165).
- Disconnect the USB cable, and connect it again firmly.
- Set [USB Connection] to [Mass Storage] (page 165).
- Disconnect all equipment other than the camera, the keyboard and the mouse from the USB jacks of your computer.
- Connect the camera directly to your computer without passing through a USB hub or other device (page 165).

---

### **You cannot copy images.**

- Make the USB connection by properly connecting the camera with your computer (page 165).
- Follow the designated copy procedure for your OS (page 165).
- When you shoot images with a memory card formatted by a computer, you may not be able to copy the images to a computer. Shoot using a memory card formatted by your camera (page 146).

---

### **The image cannot be played back on a computer.**

- If you are using “PMB,” refer to the “PMB Help.”
- Consult the computer or software manufacturer.

---

### **After making a USB connection, “PMB” does not start automatically.**

- Make the USB connection after the computer is turned on (page 165).

## Memory card

### **Cannot insert a memory card.**

- Insertion direction of the memory card is wrong. Insert it in the correct direction (page 20).

---

### **Cannot record on a memory card.**

- The memory card is full. Delete unnecessary images (page 132).
- An unusable memory card is inserted (page 20).

---

### **You have formatted a memory card by mistake.**

- All the data on the memory card are deleted by formatting. You cannot restore it.

## Printing

---

### **Cannot print images.**

- RAW images cannot be printed. To print RAW images first, convert them to JPEG images using “Image Data Converter SR” on the supplied CD-ROM.

---

### **The color of the image is strange.**

- When you print the images recorded in Adobe RGB mode using sRGB printers that are not compatible with Adobe RGB (DCF2.0/Exif2.21), the images are printed at a lower intensity level (page 111).

---

### **Images are printed with both edges cut off.**

- Depending on your printer, the left, right, top, and bottom edges of the image may be cut off. Especially when you print an image shot with the aspect ratio set to [16:9], the lateral end of the image may be cut off.
- When printing images using your own printer, cancel the trimming or borderless settings. Consult the printer manufacturer as to whether the printer provides these functions or not.
- When having images printed at a digital print shop, ask the shop whether they can print the images without cutting off both edges.

---

### **Cannot print images with the date.**

- Using “PMB,” you can print images with date (page 163).
- This camera does not have a feature for superimposing dates on images. However, because the images shot with the camera include information on the recording date, you can print images with the date superimposed if the printer or the software can recognize Exif information. For compatibility with Exif information, consult the manufacturer of the printer or the software.

- When you print images at a shop, images can be printed with the date if you ask them to do so.

## Others

### **The lens gets fogged.**

- Moisture condensation has occurred. Turn off the camera and leave it for about an hour before using it (page 192).

---

### **The message “Set Area/Date/Time.” appears when you turn on the camera.**

- The camera has been left unused for sometime with a low battery or no battery pack. Charge the battery pack and set the date again (pages 28, 192). If the date setting is lost every time the battery pack is charged, consult your Sony dealer or local authorized Sony service facility.

---

### **The number of recordable images does not decrease or decreases two at a time.**

- This is because the compression rate and the image size after compression change depending on the image when you shoot a JPEG image (page 143).

---

### **The setting is reset without the resetting operation.**

- The battery pack was removed when the power switch was set to ON. When removing the battery pack, make sure the camera is turned off and the access lamp is not lit (pages 15, 20).

---

### **The camera does not work properly.**

- Turn off the camera. Remove the battery pack and insert it again. If the camera is hot, remove the battery pack, and allow it to cool down before trying this corrective procedure.
- If an AC Adaptor (sold separately) is used, disconnect the power plug. Connect the power plug and turn on the camera again. If the camera does not work after doing these solutions, consult your Sony dealer or local authorized Sony service facility.

---

**The five bars of the SteadyShot scale flashes.**

- The SteadyShot function does not work. You can continue to shoot but the SteadyShot function will not work. Turn the camera off and on. If the SteadyShot scale continues to flash, consult your Sony dealer or local authorized Sony service facility.

---

**“--E-” is indicated on the screen.**

- Remove the memory card, and insert it again. If this procedure does not turn off the indication, format the memory card.



# Warning messages

If the following messages appear, follow the instructions below.

---

## Incompatible battery. Use correct model.

- An incompatible battery pack is being used.

---

## Set Area/Date/Time.

- Set the area and date, time. If you have not used the camera for a long time, charge the internal rechargeable battery (pages 28, 192).

---

## Power insufficient.

- You tried to perform [Cleaning Mode] when the battery level is insufficient. Charge the battery pack or use the AC Adaptor (sold separately).

---

## Unable to use memory card. Format?

- The memory card was formatted on a computer and the file format was modified. Select [Enter], then format the memory card. You can use the memory card again, however, all previous data in the memory card is erased. It may take a some time to complete the format. If the message still appears, change the memory card.

---

## Memory Card Error

- An incompatible memory card is inserted or the format has failed.

---

## Reinsert memory card.

- The inserted memory card cannot be used in your camera.
- The memory card is damaged.
- The terminal section of the memory card is dirty.

---

## Memory card locked.

- You are using a memory card with a write-protect switch, and the switch is set to the LOCK position. Set the switch to the recording position.

---

## This memory card may not be capable of recording and playing normally.

- The inserted memory card cannot be used with the camera.

---

## Processing...

- When Long exposure noise reduction will be done for the same amount of time that the shutter was open. You cannot do any further shooting during this reduction.

---

## Unable to display.

- Images recorded with other cameras or images modified with a computer may not be able to be displayed.

---

**Check the lens attachment. If the lens is not supported, you can permit use of the lens in the custom menu.**

- The lens is not attached properly, or the lens is not attached.
- When attaching the camera to an astronomical telescope or something similar, set [Release w/oLens] to [Enable].

---

**Contains no still images.**

**Contains no movies.**

- There is no image in the memory card.

---

**Image protected.**

- You tried to delete protected images.

---

**Unable to print.**

- You tried to mark RAW images with a DPOF mark.

---

**Camera overheating. Allow it to cool.**

- The camera has become hot because you have been shooting continuously. Turn the power off. Cool the camera and wait until the camera is ready to shoot again.



- Because you have been recording for a long time, the temperature inside the camera has increased to an unacceptable level. Stop recording.

---

**Recording is unavailable in this movie format.**

- Set [Movie: File Format] to [MP4].



- The number of images exceeds that for which date management in a database file by the camera is possible.



- Unable to register to the database file. Import all the images to a computer using “PMB” and recover the memory card.

---

**Camera Error  
System Error**

- Turn the power off, remove the battery pack, then re-insert it. If the message appears frequently, consult your Sony dealer or local authorized Sony service facility.

---

**Image Database File error.  
Reboot.**

- There is something wrong occurred in the Image Database File. Execute [Recover Image DB] (page 147).

---

**Image Database File error.  
Recover?**

- You cannot record or play back AVCHD format movies because the Image Database File is damaged. Follow the on-screen instructions to recover data.

---

**Unable to magnify.  
Unable to rotate image.**

- Images recorded with other cameras may not be enlarged or rotated.

---

**No images changed**

- You attempted to specify DPOF without specifying images.

---

**Cannot create more folders.**

- The folder with a name beginning with “999” exists on the memory card. You cannot create any folders if this is the case.

# Precautions

## Do not use/store the camera in the following places

- In an extremely hot, dry or humid place  
In places such as in a car parked in the sun, the camera body may become deformed and this may cause a malfunction.
- Storing under direct sunlight or near a heater  
The camera body may become discolored or deformed, and this may cause a malfunction.
- In a location subject to rocking vibration
- Near strong magnetic place
- In sandy or dusty places  
Be careful not to let sand or dust get into the camera. This may cause the camera to malfunction, and in some cases this malfunction cannot be repaired.

## On storing

Be sure to attach the lens cap or body cap when not using the camera. When attaching the body cap, remove all the dust from the cap before placing it on the camera. When you purchase the DT 18 – 55 mm F3.5 – 5.6 SAM Lens Kit, purchase the Rear Lens Cap ALC-R55 also.

## On operating temperatures

Your camera is designed for use under the temperatures between 0 and 40°C (32 and 104°F). Shooting in extremely cold or hot places that exceed this range is not recommended.

## On moisture condensation

If the camera is brought directly from a cold to a warm location, moisture may condense inside or outside the camera. This moisture condensation may cause a malfunction of the camera.

### How to prevent moisture condensation

When bringing the camera from a cold place to a warm place, seal the camera in a plastic bag and allow it to adapt to conditions at the new location over about an hour.

### If moisture condensation occurs

Turn off the camera and wait about an hour for the moisture to evaporate. Note that if you attempt to shoot with moisture remaining inside the lens, you will be unable to record clear images.

## On the internal rechargeable battery

This camera has an internal rechargeable battery for maintaining the date and time and other settings regardless of whether the power is on or off, or the battery pack is charged or discharged.

This rechargeable battery is continually charged as long as you are using the camera. However, if you use the camera for only short periods, it discharges gradually, and if you do not use the camera at all for about 3 months it becomes completely discharged. In this case, be sure to charge this rechargeable battery before using the camera.

However, even if this rechargeable battery is not charged, you can still use the camera as long as you do not record the date and time. If the camera resets the settings to the defaults each time you charge the battery, the internal rechargeable battery may be dead. Consult your Sony dealer or local authorized Sony service facility.

### **Charging method of the internal rechargeable battery**

Insert a charged battery pack in the camera, or connect the camera to a wall outlet (wall socket) using the AC Adaptor (sold separately), and leave the camera for 24 hours or more with the power off.

### **On memory cards**

Do not attach a label, etc. on a memory card or a card adaptor. This may cause a malfunction.

### **Notes on recording/playback**

- When you use a memory card with this camera for the first time, it is recommended to format the card using the camera for stable performance of the memory card

before shooting. Note that formatting permanently erases all data on the memory card, and is unrecoverable. Save precious data on a computer, etc.

- If you repeatedly record/delete images, fragmentation of data may occur on the memory card. Movies may not be able to be saved or recorded. In such a case, save your images to a computer or other storage location, then format the memory card (page 146).
- Before you record one-time events, make a trial recording to make sure that the camera is working correctly.
- This camera is neither dust-proof, nor splash-proof, nor water-proof.
- Do not look at the sun or a strong light through a removed lens or the viewfinder. This may cause irrecoverable damage to your eyes. Or it may cause a malfunction of your camera.
- Do not use the camera near a location that generates strong radio waves or emits radiation. The camera may not be able to record or play back properly.
- Using the camera in sandy or dusty locations may cause malfunctions.
- If moisture condensation occurs, remove it before using the camera (page 192).
- Do not shake or strike the camera. In addition to malfunctions and an inability to record images, this may render the memory card unusable, or cause image data breakdown, damage or loss.

- Clean the flash surface before use. The heat of flash emission may cause dirt on the flash surface to become discolored or to stick to the flash surface, resulting in insufficient light emission.
- Keep the camera, supplied accessories, etc., out of the reach of children. A memory card, etc., may be swallowed. If such a problem occurs, consult a doctor immediately.

# AVCHD format

The AVCHD format is a high definition digital video camera format used to record a high definition (HD) signal of either the 1080i specification\*<sup>1</sup> or the 720p specification\*<sup>2</sup> using efficient data compression coding technology. The MPEG-4 AVC/H.264 format is adopted to compress video data, and the Dolby Digital or Linear PCM system is used to compress audio data.

The MPEG-4 AVC/H.264 format is capable of compressing images at higher efficiency than that of the conventional image compressing format. The MPEG-4 AVC/H.264 format enables a high definition video signal shot on a digital video camera recorder to be recorded on 8 cm DVD discs, hard disk drive, flash memory, memory card, etc.

## Recording and playback on your camera

Based on the AVCHD format, your camera records with the high definition image quality (HD) mentioned below.

Video signal\*<sup>3</sup>:

### 1080 60i-compatible device

MPEG-4 AVC/H.264 1920 ×  
1080/60i

### 1080 50i-compatible device

MPEG-4 AVC/H.264 1920 ×  
1080/50i

Audio signal: Dolby Digital 2ch

Recording media: Memory card

### \*1 1080i specification

A high definition specification which utilizes 1,080 effective scanning lines and the interlace system.

### \*2 720p specification

A high definition specification which utilizes 720 effective scanning lines and the progressive system.

### \*3 Data recorded in AVCHD format other than the above mentioned cannot be played on your camera.

## GPS (SLT-A55V only)

This system allows you to pinpoint your exact location on the earth. The GPS satellites are located in 6 orbits, 20,000 km above the earth. The GPS system consists of 24 or more GPS satellites. A GPS receiver receives radio signals from the satellites, and calculates the current location of the receiver based on the orbital information (almanac data) and travel time of the signals, etc.

Determining a location is called “triangulating.” A GPS receiver can determine the location’s latitude and longitude by receiving signals from 3 or more satellites.

- As the positions of GPS satellites vary constantly, it may take longer to determine the location or the receiver may not be able to determine the location at all, depending on the location and time you use the camera.
- “GPS” is a system for determining geographic location by triangulating radio signals from GPS satellites. Avoid using the camera in places where radio signals are blocked or reflected, such as a shadowy place surrounded by buildings or trees, etc. Use the camera in open sky environments.
- You may not be able to record location information at locations or in situations where radio signals

from the GPS satellites do not reach the camera as follows.

- In tunnels, indoors or under the shade of buildings.
- Between tall buildings or at narrow streets surrounded by buildings.
- In underground locations, locations surrounded by dense trees, under an elevated bridge, or in locations where magnetic fields are generated, such as near high voltage cables.
- Near devices that generate radio signals of the same frequency band as the camera: near 1.5 GHz band mobile telephones, etc.

### On triangulating errors

- If you move to another location right after turning on the camera, it may take a longer time for the camera to start triangulating, compared to when you stay in the same place.
- If triangulating fails, previously-triangulated location information may be written onto the image in the camera.
- Error caused by the position of GPS satellites  
The camera automatically triangulates your current location when the camera receives radio signals from 3 or more GPS satellites. The triangulating error allowed by the GPS satellites is about 30 m (98 feet). Depending on the environment of the location, the triangulating error can be greater. In this case, your actual location may



not match the location on the map based on the GPS information. Meanwhile, the GPS satellites are controlled by the United States Department of Defense, and the degree of accuracy may be changed intentionally.

- Error during the triangulating process

The camera acquires location information every about 15 seconds during triangulating. There is a slight time difference between when the location information is acquired and when the location information is recorded on an image, therefore, the actual recording location may not match exactly the location on the map based on the GPS information.

## **On the restriction of use of GPS on an airplane**

During take off and landing of an airplane, turn off the camera, as you will be instructed to do by the on-board announcement.

## **On the other restriction**

Use GPS in accordance with the regulations of the place or situation.

## **On the geographic coordinate system**

The “WGS-84” geographic coordinate system is used.

# 3D-shootings

## Notes on recording

- [3D Panorama] is not suitable when shooting:
  - Subjects are moving.
  - Subjects are too close to the camera.
  - Subjects with a repeating pattern such as tiles, and subjects with little contrast such as sky, sandy beach, or lawn.
- [3D Panorama] recording may be discontinued in the following situations:
  - You pan or tilt the camera too fast or too slow.
  - There is too much camera shake.
- If you cannot pan or tilt the camera across the entire subject within the given time, a black area occurs in the composed image. If this happens, move the camera fast to record a full panoramic image.
- Since several images are stitched together, the stitched part will not be recorded smoothly.
- Under low light conditions, images may be blurred.
- Under lights that flicker such as fluorescent light, images may not be recorded properly.
- When the whole angle of 3D panoramic shooting and the angle in which you fixed the focus and exposure with AE/AF lock are extremely different in brightness, color and focus, the shooting will not be successful. If this happens,

change the lock angle and shoot again.

- The available shooting direction is horizontal only.
- For details on the procedure used for shooting 3D-images, see page 68.

## Note on playback of 3D-images

When you play back 3D-images on the LCD monitor of the camera or on a non-3D-compatible TV, the images are played back without the 3D effect.

## Notes on 3D-image files

- A JPEG file and an MPO are combined to create a 3D-image. If you erase one of these files from the computer, the 3D-image may not be played back properly.
- For details on the procedure used for viewing 3D-images, see pages 126 and 135.

# Index

## Numerics

3D..... 68, 198

## A

Adobe RGB..... 111

AE Lock..... 100

AEL button..... 150

AF area..... 89

AF illuminator..... 98

Ambient light..... 119

Amount of exposure..... 70

Anti-dust function..... 36

Aperture..... 70, 72

Aperture priority..... 72

Aperture value..... 72

Area Setting..... 29

Aspect ratio..... 143

Audio signals..... 151

Auto HDR..... 108

Auto review..... 154

AUTO+..... 61

Autoflash..... 96

Autofocus..... 85

Autofocus mode..... 88

AVCHD..... 195

## B

Battery pack..... 18, 20

Bracket..... 118

“BRAVIA” Sync..... 136

BULB shooting..... 79

## C

Center weighted..... 105

Charging battery pack..... 18

Cleaning mode..... 36

Color filter..... 113

Color Space..... 111

Color temperature..... 113

Compression ratio..... 143

Connection plate cover..... 17

Continuous Advance Priority AE  
..... 69

Continuous AF..... 88

Continuous bracket..... 118

Continuous shooting..... 116

Contrast..... 110

Control button..... 46

Creative Style..... 110

CTRL FOR HDMI..... 136

Custom white balance..... 114

## D

Date imprint..... 173

Date/Time setup..... 28

Delete..... 132

Depth of field..... 70

Digital level gauge..... 40

Diopeter-adjustment..... 29

Disc creation..... 168

|                         |     |
|-------------------------|-----|
| DPOF setup .....        | 172 |
| D-Range Optimizer ..... | 107 |
| Drive mode .....        | 116 |

## E

|                             |              |
|-----------------------------|--------------|
| Enlarged image .....        | 124          |
| EV scale .....              | 78, 101, 119 |
| Exposure .....              | 70           |
| Exposure compensation ..... | 101          |
| Exposure mode .....         | 70           |
| Eyecup .....                | 31           |
| Eye-Fi .....                | 147          |
| Eyepiece sensors .....      | 39           |
| Eye-Start AF .....          | 39           |

## F

|                          |        |
|--------------------------|--------|
| Face Detection .....     | 93     |
| File Number .....        | 145    |
| Fill-flash .....         | 96     |
| Flash bracket .....      | 118    |
| Flash compensation ..... | 103    |
| Flash control .....      | 104    |
| Flash mode .....         | 96     |
| Flash Off .....          | 59, 96 |
| Fn button .....          | 46     |
| Focal length .....       | 176    |
| Focus .....              | 85     |
| Focus indicator .....    | 86     |
| Focus Magnifier .....    | 91     |
| Focus mode .....         | 88     |
| Focus-lock .....         | 87     |
| Folder Name .....        | 145    |
| Format .....             | 146    |

## G

|                         |     |
|-------------------------|-----|
| GPS assist data .....   | 139 |
| GPS Auto Time Cor ..... | 140 |
| GPS On/Off .....        | 138 |

## H

|                          |     |
|--------------------------|-----|
| Hand-held Twilight ..... | 63  |
| Help Guide disp. ....    | 151 |
| High ISO NR .....        | 149 |
| High-speed sync .....    | 97  |
| Histogram .....          | 102 |

## I

|                       |     |
|-----------------------|-----|
| Image Index .....     | 125 |
| Image quality .....   | 143 |
| Image size .....      | 141 |
| ISO sensitivity ..... | 106 |

## J

|            |     |
|------------|-----|
| JPEG ..... | 143 |
|------------|-----|

## L

|                      |             |
|----------------------|-------------|
| Landscape .....      | 63          |
| Language .....       | 152         |
| LCD brightness ..... | 153         |
| LCD monitor .....    | 42, 55, 127 |
| Lens .....           | 26          |
| Live View .....      | 7           |
| Long exp.NR .....    | 149         |

## M

|                       |    |
|-----------------------|----|
| Macro .....           | 63 |
| Manual exposure ..... | 77 |

|                                  |        |
|----------------------------------|--------|
| Manual focus.....                | 90     |
| Manual shift .....               | 78     |
| Memory card.....                 | 20, 23 |
| “Memory Stick PRO Duo”<br>.....  | 20, 23 |
| Menu .....                       | 49     |
| Metering mode.....               | 105    |
| Moisture condensation.....       | 192    |
| Movie Audio Rec.....             | 82     |
| Movie File Format .....          | 82     |
| Multi frame noise reduction..... | 106    |
| Multi segment .....              | 105    |

## N

|                                      |        |
|--------------------------------------|--------|
| New Folder .....                     | 146    |
| Night Portrait .....                 | 63     |
| Night View.....                      | 63     |
| Noise reduction .....                | 149    |
| Number of recordable images<br>..... | 32, 33 |

## P

|                             |     |
|-----------------------------|-----|
| PlaybackDisplay .....       | 121 |
| PMB .....                   | 163 |
| PMB Launcher.....           | 162 |
| Portrait .....              | 63  |
| Power Save .....            | 151 |
| Preset white balance.....   | 112 |
| Pressing halfway down ..... | 60  |
| Preview .....               | 74  |
| Print.....                  | 172 |
| Program auto.....           | 71  |
| Protect .....               | 131 |

## Q

|              |     |
|--------------|-----|
| Quality..... | 143 |
|--------------|-----|

## R

|                            |         |
|----------------------------|---------|
| RAW .....                  | 143     |
| Rear sync.....             | 96      |
| Recording movies .....     | 81      |
| Recover Image DB.....      | 147     |
| Red eye reduc.....         | 98      |
| Reducing camera shake..... | 56      |
| Remote Commander .....     | 17, 120 |
| Reset.....                 | 156     |
| Rotate .....               | 123     |

## S

|                             |        |
|-----------------------------|--------|
| Saturation .....            | 110    |
| Scene Selection .....       | 63     |
| Select Folder .....         | 121    |
| Select REC Folder.....      | 146    |
| Self-timer .....            | 117    |
| Set the clock.....          | 28     |
| Sharpness .....             | 110    |
| Shooting .....              | 59     |
| Shoulder strap .....        | 30     |
| Shutter speed.....          | 70, 75 |
| Shutter speed priority..... | 75     |
| Single-shot AF .....        | 88     |
| Slide show .....            | 125    |
| Slow sync.....              | 96     |
| Smile Shutter.....          | 94     |
| Specifications .....        | 174    |
| Sports Action.....          | 63     |

|                          |         |
|--------------------------|---------|
| Spot.....                | 105     |
| SteadyShot function..... | 57      |
| Sunset .....             | 63      |
| Sweep Panorama .....     | 66, 142 |
| Sweep Shooting .....     | 66      |

## **U**

|                     |     |
|---------------------|-----|
| USB connection..... | 165 |
|---------------------|-----|

## **V**

|  |         |
|--|---------|
| Version .....                          | 155     |
| Viewfinder .....                       | 39, 154 |
| Viewing image.....                     | 121     |
| Viewing images on a TV screen<br>..... | 134     |

## **W**

|                                    |     |
|------------------------------------|-----|
| White balance .....                | 112 |
| White balance bracket .....        | 119 |
| Wireless flash .....               | 99  |
| Wireless Remote Commander<br>..... | 120 |

## Notes on the License

“C Library”, “Expat”, “zlib”, “dtoa”, “pcre”, and “libjpeg” software are provided in the camera. We provide this software based on license agreements with their owners of copyright. Based on requests by the owners of copyright of these software applications, we have an obligation to inform you of the following. Please read the following sections. Read “license1.pdf” in the “License” folder on the CD-ROM. You will find licenses (in English) of “C Library”, “Expat”, “zlib”, “dtoa”, “pcre” and “libjpeg” software.

THIS PRODUCT IS LICENSED UNDER THE AVC PATENT PORTFOLIO LICENSE FOR THE PERSONAL AND NON-COMMERCIAL USE OF A CONSUMER TO

- (i) ENCODE VIDEO IN COMPLIANCE WITH THE AVC STANDARD (“AVC VIDEO”) AND/OR
- (ii) DECODE AVC VIDEO THAT WAS ENCODED BY A CONSUMER ENGAGED IN A PERSONAL AND NON-COMMERCIAL ACTIVITY AND/OR WAS OBTAINED FROM A VIDEO PROVIDER LICENSED TO PROVIDE AVC VIDEO.

NO LICENSE IS GRANTED OR SHALL BE IMPLIED FOR ANY OTHER USE.

ADDITIONAL INFORMATION MAY BE OBTAINED FROM MPEG LA, L.L.C.

SEE

[HTTP://WWW.MPEGLA.COM](http://WWW.MPEGLA.COM)

## On GNU GPL/LGPL applied software

The software that is eligible for the following GNU General Public License (hereinafter referred to as “GPL”) or GNU Lesser General Public License (hereinafter referred to as “LGPL”) are included in the camera.

This informs you that you have a right to have access to, modify, and redistribute source code for these software programs under the conditions of the supplied GPL/ LGPL.

Source code is provided on the web. Use the following URL to download it.

<http://www.sony.net/Products/Linux/>  
We would prefer you do not contact us about the contents of source code.

Read “license2.pdf” in the “License” folder on the CD-ROM. You will find licenses (in English) of “GPL”, and “LGPL” software.

To view the PDF, Adobe Reader is needed. If it is not installed on your computer, you can download it from the Adobe Systems web page: <http://www.adobe.com/>