

SONY®

4-147-790-12 (1)

α

Preparing the camera

Before your operation

Shooting images

Using the shooting  
function

Using the viewing  
function

Changing your setup

Viewing images on a  
computer

Printing images

Additional information on this product and answers to frequently asked questions can be found at our Customer Support Website.

<http://www.sony.net/>

Printed using VOC (Volatile Organic Compound)-free vegetable oil based ink.

Printed in Thailand



4 147790 120

α230

Digital Single Lens Reflex Camera  
**Instruction Manual**

**DSLR-A230**



© 2009 Sony Corporation

## Owner's Record

The model and serial numbers are located on the bottom.

Record the serial number in the space provided below.

Refer to these numbers whenever you call upon your Sony dealer regarding this product.

Model No. DSLR-A230

Serial No. \_\_\_\_\_

## WARNING

**To reduce fire or shock hazard, do not expose the unit to rain or moisture.**

# IMPORTANT SAFETY INSTRUCTIONS SAVE THESE INSTRUCTIONS. DANGER - TO REDUCE THE RISK OF FIRE OR ELECTRIC SHOCK, CAREFULLY FOLLOW THESE INSTRUCTIONS.

If the shape of the plug does not fit the power outlet, use an attachment plug adaptor of the proper configuration for the power outlet.

## Caution

### Battery pack

If the battery pack is mishandled, the battery pack can burst, cause a fire or even chemical burns. Observe the following cautions.

- Do not disassemble.
- Do not crush and do not expose the battery pack to any shock or force such as hammering, dropping or stepping on it.
- Do not short circuit and do not allow metal objects to come into contact with the battery terminals.
- Do not expose to high temperature above 60°C (140°F) such as in direct sunlight or in a car parked in the sun.
- Do not incinerate or dispose of in fire.
- Do not handle damaged or leaking lithium ion batteries.
- Be sure to charge the battery pack using a genuine Sony battery charger or a device that can charge the battery pack.

- Keep the battery pack out of the reach of small children.
- Keep the battery pack dry.
- Replace only with the same or equivalent type recommended by Sony.
- Dispose of used battery pack promptly described the instructions.

### Battery charger

Even if the CHARGE lamp is not lit, the battery charger is not disconnected from the AC power source (mains) as long as it is connected to the wall outlet (wall socket). If some trouble occurs while using the battery charger, immediately shut off the power by disconnecting the plug from the wall outlet (wall socket).

## For Customers in the U.S.A. and Canada

### RECYCLING LITHIUM-ION BATTERIES

Lithium-Ion batteries are recyclable.

You can help preserve our environment by returning your used rechargeable batteries to the collection and recycling location nearest you.

For more information regarding recycling of rechargeable batteries, call toll free 1-800-822-8837, or visit <http://www.rbrc.org/>



**Caution:** Do not handle damaged or leaking Lithium-Ion batteries.

### Battery pack

This device complies with Part 15 of the FCC Rules, Operation is subject to the following two conditions:

(1) This device may not cause harmful interference, and (2) this device must accept any interference received, including interference that may cause undesired operation.

This Class B digital apparatus complies with Canadian ICES-003.

## For Customers in the U.S.A.

UL is an internationally recognized safety organization.

The UL Mark on the product means it has been UL Listed.

If you have any questions about this product, you may call:

Sony Customer Information Services  
Center  
1-800-222-SONY (7669)

The number below is for the FCC related matters only.

### Regulatory Information

Declaration of Conformity

Trade Name: SONY

Model No.: DSLR-A230

Responsible Party: Sony Electronics Inc.

Address: 16530 Via Esprillo,

San Diego, CA 92127 U.S.A.

Telephone No.: 858-942-2230

This device complies with Part 15 of the FCC Rules. Operation is subject to the following two conditions: (1) This device may not cause harmful interference, and (2) this device must accept any interference received, including interference that may cause undesired operation.

### CAUTION

You are cautioned that any changes or modifications not expressly approved in this manual could void your authority to operate this equipment.

**Note:**

This equipment has been tested and found to comply with the limits for a Class B digital device, pursuant to Part 15 of the FCC Rules.

These limits are designed to provide reasonable protection against harmful interference in a residential installation. This equipment generates, uses, and can radiate radio frequency energy and, if not installed and used in accordance with the instructions, may cause harmful interference to radio communications. However, there is no guarantee that interference will not occur in a particular installation. If this equipment does cause harmful interference to radio or television reception, which can be determined by turning the equipment off and on, the user is encouraged to try to correct the interference by one or more of the following measures:

- Reorient or relocate the receiving antenna.
- Increase the separation between the equipment and receiver.
- Connect the equipment into an outlet on a circuit different from that to which the receiver is connected.
- Consult the dealer or an experienced radio/TV technician for help.

The supplied interface cable must be used with the equipment in order to comply with the limits for a digital device pursuant to Subpart B of Part 15 of FCC Rules.

**For Customers in Europe****Notice for the customers in the countries applying EU Directives**

The manufacturer of this product is Sony Corporation, 1-7-1 Konan Minato-ku Tokyo, 108-0075 Japan. The Authorized Representative for EMC and product safety is Sony Deutschland GmbH, Hedelfinger Strasse 61, 70327 Stuttgart, Germany. For any service or guarantee matters please refer to the addresses given in separate service or guarantee documents.

This product has been tested and found compliant with the limits set out in the EMC Directive for using connection cables shorter than 3 meters (9.8 feet).

**Attention**

The electromagnetic fields at the specific frequencies may influence the picture and sound of this unit.

**Notice**

If static electricity or electromagnetism causes data transfer to discontinue midway (fail), restart the application or disconnect and connect the communication cable (USB, etc.) again.

### **Disposal of Old Electrical & Electronic Equipment (Applicable in the European Union and other European countries with separate collection systems)**



This symbol on the product or on its packaging indicates that this product shall not be treated as household waste. Instead it shall be handed over to the applicable collection point for the recycling of electrical and electronic equipment. By ensuring this product is disposed of correctly, you will help prevent potential negative consequences for the environment and human health, which could otherwise be caused by inappropriate waste handling of this product. The recycling of materials will help to conserve natural resources. For more detailed information about recycling of this product, please contact your local Civic Office, your household waste disposal service or the shop where you purchased the product.

### **Disposal of waste batteries (applicable in the European Union and other European countries with separate collection systems)**



This symbol on the battery or on the packaging indicates that the battery provided with this product shall not be treated as household waste.

By ensuring these batteries are disposed of correctly, you will help prevent potentially negative consequences for the environment and human health which could otherwise be caused by inappropriate waste handling of the battery. The recycling of the materials will help to conserve natural resources.



In case of products that for safety, performance or data integrity reasons require a permanent connection with an incorporated battery, this battery should be replaced by qualified service staff only. To ensure that the battery will be treated properly, hand over the product at end-of-life to the applicable collection point for the recycling of electrical and electronic equipment.

For all other batteries, please view the section on how to remove the battery from the product safely. Hand the battery over to the applicable collection point for the recycling of waste batteries.

For more detailed information about recycling of this product or battery, please contact your local Civic Office, your household waste disposal service or the shop where you purchased the product.

## Notice for customers in the United Kingdom

A moulded plug complying with BS 1363 is fitted to this equipment for your safety and convenience.

Should the fuse in the plug supplied need to be replaced, a fuse of the same rating as the supplied one and approved by ASTA or BSI to BS 1362, (i.e., marked with an  or  mark) must be used.

If the plug supplied with this equipment has a detachable fuse cover, be sure to attach the fuse cover after you change the fuse.

Never use the plug without the fuse cover.

If you should lose the fuse cover, please contact your nearest Sony service station.

# Notes on using your camera

## No compensation for contents of the recording

The contents of the recording cannot be compensated for if recording or playback is not possible due to a malfunction of your camera or a memory card, etc.

## Back up recommendation

To avoid the potential risk of data loss, always copy (back up) data to other medium.

## Notes on the LCD monitor and lens

- The LCD monitor is manufactured using extremely high-precision technology so over 99.99% of the pixels are operational for effective use. However, there may be some tiny black points and/or bright points (white, red, blue or green in color) that constantly appear on the LCD monitor. These points are normal in the manufacturing process and do not affect the images in any way.



Black, white, red,  
blue and green  
points

- Do not expose the camera to direct sunlight. If sunlight is focused on a nearby object, it may cause a fire. When you must place the camera under direct sunlight, attach the lens cap.
- Images may trail across on the LCD monitor in a cold location. This is not a malfunction. When turning on the camera in a cold location, the LCD monitor may become temporarily dark. When the camera warms up, the monitor will function normally.
- Do not press against the LCD monitor. The monitor may be discolored and that may cause a malfunction.

## Warning on copyright

Television programs, films, videotapes, and other materials may be copyrighted.

Unauthorized recording of such materials may be contrary to the provisions of the copyright laws.







## The pictures used in this manual

The photographs used as examples of pictures in this manual are reproduced images, and are not actual images shot using this camera.

## On the data specifications described in this Instruction Manual

The data on performance and specifications is defined under the following conditions, except as described in this Instruction Manual: at an ordinary ambient temperature of 25°C (77°F), and using a fully charged battery pack.

# Table of Contents

	Notes on using your camera .....	7
<b>Preparing the camera</b>	Checking the accessories supplied .....	11
	Preparing the battery pack .....	12
	Attaching a lens .....	18
	Inserting a memory card .....	20
	Preparing the camera .....	23
	Using the accessories supplied .....	25
	Checking the number of recordable images .....	27
	Cleaning .....	29
<b>Before your operation</b>	Identifying parts and screen indicators .....	32
	Front side .....	32
	Rear side .....	33
	Sides/Bottom .....	34
	Switching the recording information display (DISP) .....	35
	LCD monitor (Graphic Display) .....	36
	LCD monitor (Standard Display) .....	38
	Viewfinder .....	40
	Selecting a function/setting .....	41
	The functions selected by the Control button .....	42
	The functions selected by the Fn (Function) button ...	43
The functions selected by the MENU button .....	43	
<b>Shooting images</b>	Shooting an image without camera shake .....	45
	Correct posture .....	45
	Using the SteadyShot function .....	46
	Using a tripod .....	47
	<b>AUTO</b> /  Shooting with the automatic setting.....	48
	Shooting with a suitable setting for the subject (Scene Selection) .....	51
	 Taking portrait photos .....	52
	 Taking landscape photos .....	53
	 Taking small-subject photos .....	54
	 Taking moving-subject photos .....	55
	 Taking sunset photos .....	56
	 Taking night view photos .....	57



	Shooting an image the way you want it (Exposure mode)	58
	P Shooting with program auto	60
	A Shooting by controlling the blur of the background (Aperture priority)	61
	S Shooting a moving subject with various expressions (Shutter speed priority)	63
	M Shooting with the exposure adjusted manually (Manual exposure)	65
	M Shooting trails with long exposure (BULB)	67
<b>Using the shooting function</b>	Selecting the focus method	69
	Using autofocus	69
	Shooting with your desired composition (Focus-lock)	71
	Selecting the focus method to suit the movement of the subject (Autofocus mode)	72
	Selecting the focus area (AF area)	73
	Adjusting the focus manually (Manual focus)	74
	Using the flash	75
	Performing wireless flash shooting	78
	Adjusting the brightness of the image (Exposure, Flash compensation, Metering)	79
	Using brightness compensation for the entire image (Exposure compensation)	79
	Adjusting the amount of flash light (Flash compensation)	80
	Selecting the method for measuring the brightness of a subject (Metering mode)	81
	Setting ISO	82
	Adjusting the color tones (White balance)	83
	Adjusting the white balance to suit a specific light source (Auto/Preset white balance)	83
	Registering the color tones (Custom white balance)	84

	Image processing .....	86
	Correcting the brightness of the image (D-Range Optimizer) .....	86
	Selecting your desired image processing (Creative Style) .....	86
	Changing the range of color reproduction (Color Space) .....	88
	☺ / 📷 Selecting the drive mode .....	89
	Shooting single shot .....	89
	Shooting continuously .....	89
	Using the self-timer .....	90
	Shooting images with the exposure shifted (Exposure bracket) .....	91
	Shooting with the Remote Commander .....	93
<b>Using the viewing function</b>	Playing back images .....	94
	Checking the information of recorded images .....	98
	Protecting images (Protect) .....	101
	Deleting images (Delete) .....	102
	Viewing images on a TV screen .....	104
<b>Changing your setup</b>	Setting image size and image quality .....	108
	Setting the method for recording on a memory card .....	110
	Changing the noise reduction setting .....	112
	Changing the functions of the control dial .....	113
	Changing other settings .....	114
	Setting the LCD monitor .....	116
	Confirming the version of the camera .....	118
	Resetting to the default .....	119
<b>Viewing images on a computer</b>	Copying images to your computer .....	121
	Viewing images on your computer .....	125
	Using the software .....	129
<b>Printing images</b>	Specifying DPOF .....	135
	Printing images by connecting the camera to a PictBridge compliant printer .....	137
<b>Others</b>	Specifications .....	140
	Troubleshooting .....	144
	Warning messages .....	153
	Precautions .....	156
<b>Index</b> .....		<b>158</b>

# Checking the accessories supplied

The number in parentheses indicates the number of pieces.

- BC-VH1 Battery charger (1)

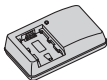

- Power cord (mains lead) (1) (not supplied in the U.S.A. and Canada)



- Rechargeable battery pack NP-FH50 (1)



- USB cable (1)



- Shoulder strap (1)

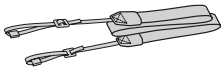

- Eyepiece cover (1)



- Body cap (1) (Attached on the camera)



- Eyecup (1) (Attached on the camera)
- CD-ROM (Application Software for  $\alpha$  camera) (1)
- Quick Start Guide (1)
- Instruction Manual (This manual) (1)

# Preparing the battery pack

When using the camera for the first time, be sure to charge the NP-FH50 “InfoLITHIUM” battery pack (supplied).

## Charging the battery pack

The “InfoLITHIUM” battery pack can be charged even when it has not been fully depleted.

It can also be used when it has not been fully charged.

---

### **1** Insert the battery pack on the battery charger.

Push the battery pack until it clicks.

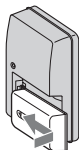

## 2 Connect the battery charger to the wall outlet (wall socket).

Light on: Charging

Light off: Normal charge completed

One hour after the lamp is turned off: Full charge completed

For customers in the U.S.A. and Canada

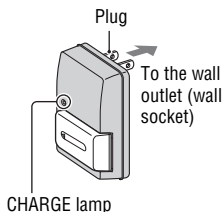

For customers in countries/regions other than the U.S.A. and Canada

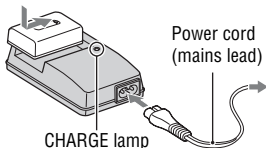

### About charging time

- Time required to charge a fully depleted battery pack (supplied) at a temperature of 25°C (77°F) is as follows.

Full charge	Normal charge
Approx. 265 min.	Approx. 205 min.

- The charging time differs depending on the remaining capacity of the battery pack or charging conditions.

### When the CHARGE lamp flashes

- The CHARGE lamp of the supplied battery charger flashes in either way:
  - Fast flashing: Turns the light on and off repeatedly at the interval of 0.15 seconds.
  - Slow flashing: Turns the light on and off repeatedly at the interval of 1.5 seconds.

- When the CHARGE lamp flashes fast, remove the battery pack being charged, and then insert the same battery pack into the battery charger securely again. When the CHARGE lamp flashes fast again, this may indicate a battery error or that a battery pack other than the specified type has been inserted. Check that the battery pack is the specified type. If the battery pack is the specified type, remove the battery pack, replace it with a new one or another one and check if the battery charger operates correctly. If the battery charger operates correctly, a battery error may have occurred.
- When the CHARGE lamp flashes slowly, it indicates that the battery charger stops charging temporarily on standby. The battery charger stops charging and enters the standby status automatically when the temperature is outside of the recommended operating temperature. When the temperature gets back within the appropriate range, the battery charger resumes charging and the CHARGE lamp lights up again. We recommend charging the battery pack in an ambient temperature of between 10°C to 30°C (50°F to 86°F).

### Notes

- Connect the battery charger to the nearest wall outlet (wall socket).
- When charging is finished, disconnect the power cord (mains lead) from the wall outlet (wall socket), and remove the battery pack from the battery charger. If you leave the charged battery pack on the charger, battery life may be decreased.
- Do not charge any battery pack other than the “InfoLITHIUM” H series battery pack in the battery charger (supplied) with your camera. Batteries other than the specified kind may leak, overheat, or explode if you attempt to charge them, posing a risk of injury from electrocution and burns.
- If the battery charger is dirty, charging may not be performed successfully. Clean the battery charger with dry cloth, etc.

### To use your camera abroad — Power sources

You can use your camera and the battery charger and the AC-PW10AM AC Adaptor (sold separately) in any country or region where the power supply is within 100 V to 240 V AC, 50/60 Hz.

### Note

- Do not use an electronic transformer (travel converter), as this may cause a malfunction.

## Inserting the charged battery pack

- 1** While sliding the battery cover open lever, open the battery cover.

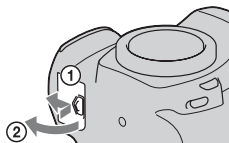

- 2** Firmly insert the battery pack all the way while pressing the lock lever with the tip of the battery.

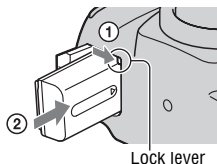

- 3** Close the battery cover.

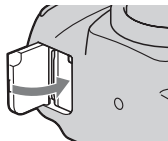





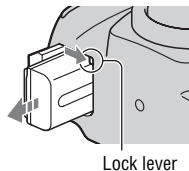

### To remove the battery pack

Turn off the camera and slide the lock lever in the direction of the arrow. Be careful not to drop the battery pack.



## To check the remaining battery level

Set the power switch to ON and check the level on the LCD monitor.

Battery level						<b>"Battery exhausted"</b>
	High  Low					You cannot shoot any more pictures.

## What is an "InfoLITHIUM" battery pack?

An "InfoLITHIUM" battery pack is a lithium-ion battery pack that has functions for exchanging information related to operating conditions with your camera.

### Notes

- The displayed level may not be correct under certain circumstances.
- Do not expose the battery pack to water. The battery pack is not water-resistant.
- Do not leave the battery pack in extremely hot places, such as in a car or under direct sunlight.

## Available battery packs

Only an NP-FH50 battery pack can be used with the camera. Note that the NP-FH30 and NP-FH40 cannot be used.

## Effective use of the battery pack

- Battery performance decreases in low temperature surroundings. So, the time that the battery pack can be used is shorter in cold places and the speed of continuous shooting slows down. We recommend that you put the battery pack in a pocket close to your body to warm it up, and insert it in your camera immediately before you start shooting.
- The battery pack will run out quickly if you use the flash frequently, use continuous shooting often, or turn the camera on and off frequently.

## Battery life

- The battery life is limited. Battery capacity decreases little by little as you use it more and more, and as time passes. If the battery operating time seems shortened considerably, a probable cause is that the battery pack has reached the end of its life. Buy a new battery pack.
- The battery life varies according to how it is stored and the operating conditions and environment in which each battery pack is used.



**How to store the battery pack**

If the battery pack is not to be used for a long time, fully charge it and then fully use it up once a year on your camera before storing the battery pack in a dry, cool place to prolong the battery life.

# Attaching a lens

---

## 1 Remove the body cap from the camera and the packaging lid from the rear of the lens.

- When changing the lens, quickly change the lens away from dusty locations so as to keep dust or debris from getting inside the camera.

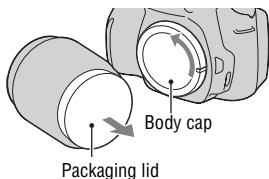

## 2 Mount the lens by aligning the orange index marks on the lens and camera.

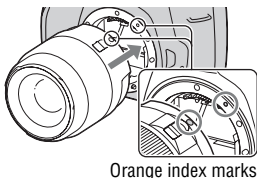

## 3 Turn the lens clockwise until it clicks into the locked position.

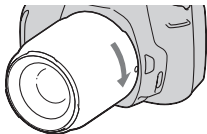

---

### Notes

- A rear lens cap is not supplied with the DT 18-55mm F3.5-5.6 SAM Lens Kit. When you store the lens without attaching it to the camera, purchase the Rear Lens Cap ALC-R55.
- When attaching a lens, do not press the lens release button.
- Do not use force when attaching a lens.

## To remove the lens

- 1 Press the lens release button all the way in and turn the lens counterclockwise until it stops.**

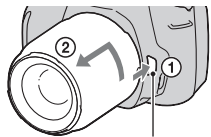

Lens release button

- 2 Replace the packaging lid on the lens and attach the body cap to the camera.**

- Before you attach them, remove dust from them.
- When you purchase the DT 18 – 55 mm F3.5 – 5.6 SAM Lens Kit, purchase the Rear Lens Cap ALC-R55 also.

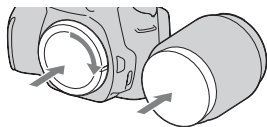

### Note on changing the lens

When changing the lens, if dust or debris gets inside the camera and lands on the surface of the image sensor (the part that acts as the film), it may appear on the image, depending on the shooting environment.

The camera is equipped with an anti-dust function to prevent dust from landing on the image sensor. However, quickly change the lens away from dusty locations when attaching/removing a lens.

### If dust or debris lands on the image sensor

Clean the image sensor using [Cleaning mode] in the  Setup menu (page 30).

# Inserting a memory card

Only “Memory Stick PRO Duo” media, “Memory Stick PRO-HG Duo” media, SD memory cards and SDHC memory cards can be used with this camera. A MultiMediaCard cannot be used with this camera.

The “Memory Stick PRO Duo” media and “Memory Stick PRO-HG Duo” media are referred to as the “Memory Stick PRO Duo” media and the SD memory card and SDHC memory card are referred to as the “SD memory card” in this Instruction Manual.

## 1 Open the memory card cover.

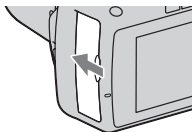

## 2 Insert “Memory Stick PRO Duo” media or an SD memory card.

- Insert the memory card until it clicks as illustrated.

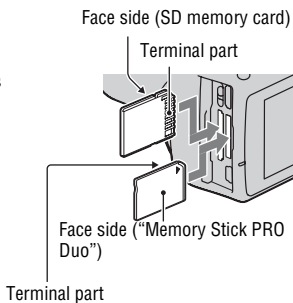

## 3 Select the type of memory card you want to use using the memory card switch.

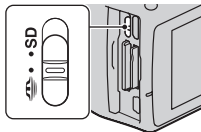

---

## 4 Close the memory card cover.

---

### To remove the memory card

Check that the access lamp is not lit, then open the memory card cover, and push the memory card once.

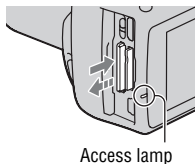



### Notes on using memory cards

- Do not strike, bend or drop the memory card.
- Do not use or store the memory card under the following conditions:
  - High temperature locations such as the hot interior of a car parked in direct sunlight.
  - Locations exposed to direct sunlight.
  - Humid locations or locations with corrosive substances present.
- The memory card may be hot just after it has been used for a long time. Be careful when you handle it.
- When the access lamp is lit, do not remove the memory card or the battery pack, or turn off the power. The data may be corrupted.
- Data may be damaged if you place the memory card near strongly-magnetized material or use the memory card in a static-prone or electrically noisy environment.
- We recommend backing up important data, such as to a hard disk of a computer.
- When you carry or store the memory card, put it in the case supplied with it.
- Do not expose the memory card to water.
- Do not touch the terminal section of the memory card with your hand or a metal object.
- When the write-protect switch of a memory card is set to the LOCK position, you cannot perform operations, such as recording or deleting images.

- The “Memory Stick PRO Duo” media with a capacity up to 16 GB or the SD memory cards with a capacity up to 32 GB have been confirmed to operate properly with this camera.
- The memory cards formatted with a computer are not guaranteed to operate with this camera.
- Data read/write speeds differ depending on the combination of the memory cards and the equipment used.
- Do not press down hard when you write down on the memo area.
- Do not attach a label on the memory cards themselves.
- Do not disassemble or modify the memory cards.
- Do not leave the memory cards within the reach of small children. They might accidentally swallow it.

### Notes on the “Memory Stick” media used with the camera

The types of “Memory Stick” media that can be used with this camera are listed in the table below. However, proper operation cannot be guaranteed for all “Memory Stick PRO Duo” media functions.

“Memory Stick PRO Duo” media*	Available with your camera	
“Memory Stick PRO-HG Duo” media*		
“Memory Stick Duo” media	Unavailable with your camera	
“Memory Stick” media and “Memory Stick PRO” media	Unavailable with your camera	

\* This is equipped with MagicGate function. MagicGate is copyright protection technology that uses encryption technology. Data recording/playback that requires MagicGate functions cannot be performed with this camera.

\* Supports high-speed data transfer using a parallel interface.

# Preparing the camera

## Setting up the date

When you turn the camera on for the first time, the date/time setup screen appears.

### 1 Set the power switch to ON to turn the camera on.

- To turn the camera off, set it to OFF.

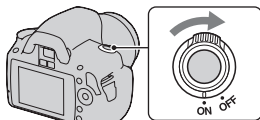

### 2 Verify that [OK] is selected on the LCD monitor, then press the center of the control button.

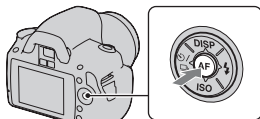

### 3 Select each item with ◀/▶ and set the numeric value with ▲/▼.

- When changing the sequence of [YYYY/MM/DD], first select [YYYY/MM/DD] with ◀/▶, then change it with ▲/▼.

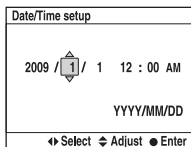
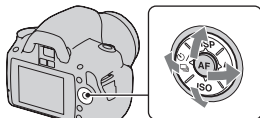

### 4 Repeat step 3 to set other items, then press the center of the control button.

---

## 5 Verify that [OK] is selected, then press the center of the control button.

---

### To cancel the date/time setting operation

Press the MENU button.

### To set up the date/time again

**MENU button** →  2 → [Date/Time setup]

## Adjusting the focus of the finder (diopter adjustment)

### Adjust the diopter-adjustment dial to your eyesight until the indicators appear clearly in the viewfinder.

- Turn the dial toward + when you are far-sighted, toward – when you are near-sighted.
- Training the camera on a light allows you to adjust the diopter easily.

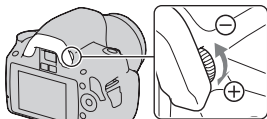

### When it is hard to rotate the diopter-adjustment dial

Put your fingers under the eyecup, and slide it upward to remove the eyecup, then adjust the diopter.

- When attaching the FDA-M1AM Magnifier (sold separately) or the FDA-A1AM Angle Finder (sold separately) to the camera, remove the eyecup as illustrated and attach them.

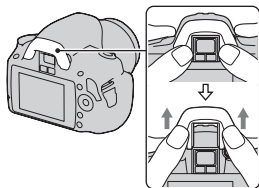



## Using the accessories supplied

This section describes how to use the shoulder strap, the eyepiece cover, and eyecup. The other accessories are described in the following pages.

- Rechargeable battery pack (page 12)
- Battery charger (page 12)
- Power cord (mains lead) (not supplied in the U.S.A. and Canada) (page 12)
- USB cable (pages 122, 138)
- CD-ROM (page 130)

### Attaching the shoulder strap

**Attach both ends of the strap onto the camera.**

- You can also attach the eyepiece cover (page 26) on the strap.

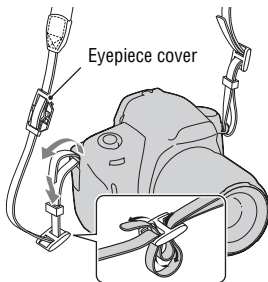

## Using the eyepiece cover and eyecup

You can prevent light from entering through the viewfinder and affecting the exposure. When the shutter is released without the use of the viewfinder, as in shooting with the self-timer, attach the eyepiece cover.

### 1 Carefully slide the eyecup off by pushing on each side of the eyecup.

- Put your fingers under the eyecup, and slide it upward.

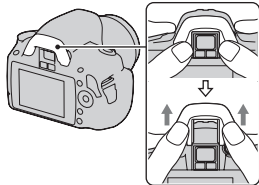

### 2 Slide the eyepiece cover over the viewfinder.

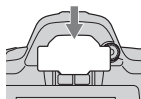

#### Note

- The eyepiece sensors located below the viewfinder may be activated depending on the situation, and the focus may be adjusted or the LCD monitor may continue to flash. In such cases, turn off both [Eye-Start AF] (page 71) and [Auto off w/ VF] (page 117).

# Checking the number of recordable images

Once you insert a memory card into the camera and set the power switch to ON, the number of images that can be recorded (should you continue to shoot using the current settings) is displayed on the LCD monitor.

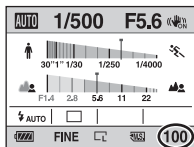

## Notes

- When “0” (the number of recordable images) flashes in yellow, the memory card is full. Replace the memory card with another one, or delete images in the current memory card (page 102).
- When “NO CARD” (the number of recordable images) flashes in yellow, it means no memory card has been inserted. Insert a memory card.

## The number of images that can be recorded on a memory card

The table shows the approximate number of images that can be recorded on a memory card formatted with this camera. The values are defined using Sony standard memory cards for testing. The values may vary depending on the shooting conditions.

**Image size: L 10M**

**Aspect ratio: 3:2\***

**“Memory Stick PRO Duo” media**

**(Units: Images)**

Size \ Capacity	1GB	2GB	4GB	8GB	16GB
Standard	320	647	1281	2575	5221
Fine	237	480	951	1910	3874
RAW & JPEG	48	98	195	392	797
RAW	60	123	245	494	1004

## SD memory card

(Units: Images)

Size \ Capacity	1GB	2GB	4GB	8GB	16GB
Standard	319	634	1277	2571	5221
Fine	236	470	947	1908	3874
RAW & JPEG	47	96	194	392	797
RAW	60	121	245	494	1004

\* When [Aspect ratio] is set to [16:9], you can record more images than the numbers shown in the table above. However, if it is set to [RAW], the number is the same as that of the [3:2] aspect ratio.

## The number of images that can be recorded using a battery pack

The approximate number of images that can be recorded is 510 when you use the camera with the battery pack (supplied) at full capacity.

Note that the actual numbers may be less than those indicated depending on the conditions of use.

- The number is calculated with a battery pack at full capacity and in the following situation:
  - At an ambient temperature of 25°C (77°F).
  - [Quality] is set to [Fine].
  - [Autofocus mode] is set to **AF-A** (Automatic AF).
  - Shooting once every 30 seconds.
  - The flash strobes once every two times.
  - The power turns on and off once every ten times.
- The measurement method is based on the CIPA standard.  
(CIPA: Camera & Imaging Products Association)

# Cleaning

## Cleaning the LCD monitor

Wipe the screen surface with a commercially available LCD cleaning kit to remove fingerprints, dust, etc.

## Cleaning the lens

- When cleaning the lens surface, remove dust using a commercially available blower. In case of dust that sticks to the surface, wipe it off with a soft cloth or tissue paper slightly moistened with lens cleaning solution. Wipe in a spiral pattern from the center to the outside. Do not spray lens cleaning solution directly onto the lens surface.
- Do not touch the inside of the camera, such as lens contacts, or the mirror. Since dust on the mirror or around the mirror may affect the autofocus system, blow away dust using a commercially available blower. If dust lands on the image sensor, it may appear on the photo image. Turn the camera to the cleaning mode, then clean it using a blower (page 30). Do not use a spray blower to clean the inside of the camera. Using this may cause a malfunction.
- Do not use a cleaning solution containing organic solvents, such as thinner, or benzene.

## Cleaning the camera surface

Clean the camera surface with a soft cloth slightly moistened with water, then wipe the surface with a dry cloth. Do not use the following as they may damage the finish or the casing.

- Chemical products such as thinner, benzene, alcohol, disposable cloths, insect repellent, sunscreen or insecticide, etc.
- Do not touch the camera with the above on your hand.
- Do not leave the camera in contact with rubber or vinyl for a long time.

## Cleaning the image sensor

If dust or debris enters the camera and lands on the image sensor (the part that acts as the film), it may appear on the photo image, depending on the shooting environment. If there is dust on the image sensor, use a commercially available blower and clean the image sensor following the steps below. You can easily clean the image sensor using only the blower and the anti-dust function.

### Notes

- Cleaning can be performed only when the battery level is  (three remaining battery icons) or more. Low battery power during cleaning can cause damage to the shutter. The cleaning should be completed quickly. The use of an AC-PW10AM AC Adaptor (sold separately) is recommended.
- Do not use a spray blower because it may scatter water droplets inside the camera body.

---

### 1 Confirm that the battery is fully charged (page 16).

---

### 2 Press the MENU button, then select 3 with / on the control button.

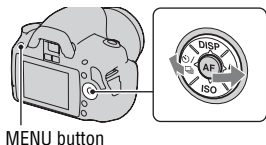

---

### 3 Select [Cleaning mode] with / , then press the center of the control button.

The message “After cleaning, turn camera off. Continue?” appears.

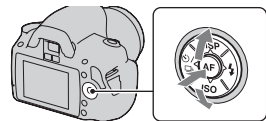

---

### 4 Select [OK] with on the control button, and press the center of the control button.

After the image sensor vibrates for a short time, the mirror in front is lifted.

---

## 5 Detach the lens (page 19).

---

## 6 Use the blower to clean the image sensor surface and the surrounding area.

- Do not touch the image sensor with the tip of the blower. Complete the cleaning quickly.
- Hold the camera's face downward to prevent the dust from resettling in the camera.
- When cleaning the image sensor, do not put the tip of a blower into the cavity beyond the mount.

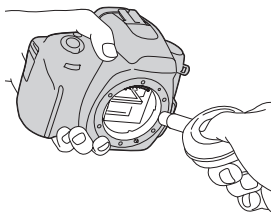

---

## 7 Attach the lens and turn the camera off.

---

### Note

- The camera starts beeping if the battery pack becomes low during cleaning. Stop cleaning immediately and turn the camera off.

# Identifying parts and screen indicators

See the pages in parentheses for details of operation.

## Front side

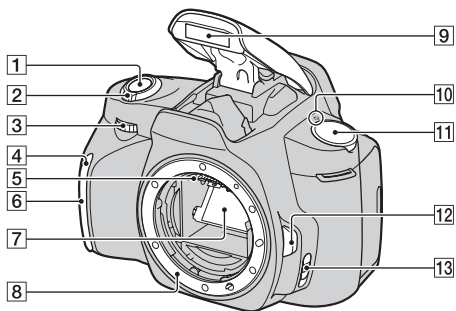

1 Shutter button (48)

2 Power switch (23)

3 Control dial (62, 113)

4 Self-timer lamp (90)

5 Lens contacts\*

6 Remote sensor

7 Mirror\*

8 Mount

9 Built-in flash\* (75)

10 ⊖ Image sensor position  
mark (71)

11 Mode dial (48 – 68)







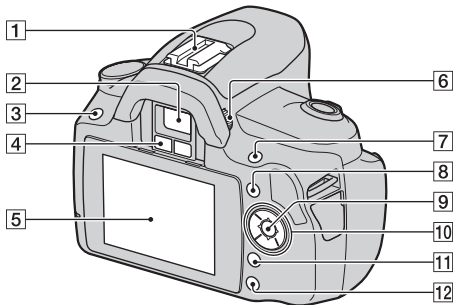

12 Lens release button (19)

13 Focus mode switch (69, 74)

**\* Do not directly touch these parts.**





- 1 Accessory shoe (78)
- 2 Viewfinder\* (24)
- 3 MENU button (43)
- 4 Eyepiece sensors (71, 117)
- 5 LCD monitor (36, 94, 98)
- 6 Diopter-adjustment dial (24)
- 7 For shooting:  (Exposure) button (79)  
For viewing:  (Zoom in) button (95)
- 8 Fn (Function) button (43)
- 9 Control button (Enter) (41)/  
Spot AF button (73)
- 10 Control button  
When the menu is turned on: /  
 (41)  
When the menu is turned off:  
DISP (35, 94)/ /  (89)/ISO  
(82)/ (75)
- 11  (Delete) button (102)
- 12  (Playback) button (94)

\* **Do not directly touch these parts.**

## Sides/Bottom

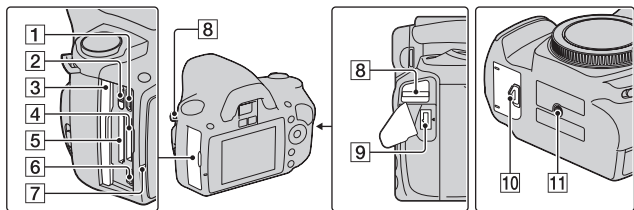

1 HDMI terminal (104)

2 Memory card switch

3 Memory card cover

4 “Memory Stick PRO Duo”  
media insertion slot (20)

5 SD memory card insertion slot  
(20)

6  (USB) terminal (122, 138)

7 Access lamp (21)

8 Hooks for shoulder strap (25)

9 DC IN terminal

- When connecting the AC-PW10AM AC Adaptor (sold separately) to the camera, turn the camera off, then plug the connector of the AC Adaptor to the DC IN terminal on the camera.

10 Battery cover (15)

11 Tripod receptacle

- Use a tripod with a screw length of less than 5.5 mm (7/32 inch). You will be unable to firmly secure the camera to tripods having screws longer than 5.5 mm (7/32 inch), and may damage the camera.

## Switching the recording information display (DISP)

Press DISP on the control button to switch between the Graphic Display and the Standard Display.

When you rotate the camera to a vertical position, the display automatically rotates to adjust to the camera position.

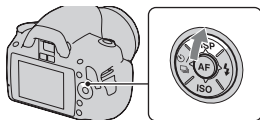

Graphic Display  
(Default setting)

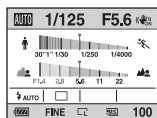

Standard Display

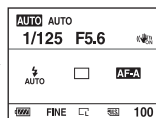

No display

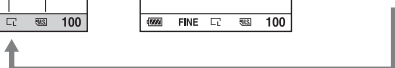

## LCD monitor (Graphic Display)

The Graphic Display graphically shows the shutter speed and aperture value and clearly illustrates how the exposure works. In AUTO or Scene Selection mode, only the items that can be set are displayed. See the pages in parentheses for details of operation.

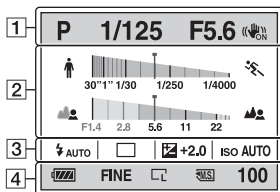

1

Display	Indication
AUTO P A S M 	Mode dial (48 – 68)
1/125	Shutter speed (63)
F5.6	Aperture (61)
	SteadyShot (46)





2

Display	Indication
	Shutter speed indicator* (63)
	Aperture indicator* (61)

\* The pointer indicates the current value.

3

Display	Indication
	Flash mode (75)/Red-eye reduction (77)
	Drive mode (89)
	Exposure compensation (79)
ISO AUTO	ISO sensitivity (82)

Display	Indication
	Remaining battery (16)
<b>RAW</b> <b>RAW+J</b> <b>FINE STD</b>	Image quality (109)
 	Image size (108)/Aspect ratio (108)
 	Memory card (20)
<b>100</b>	Remaining number of recordable images (27)

## LCD monitor (Standard Display)

See pages in parentheses for details of operation.

### In AUTO or Scene Selection mode

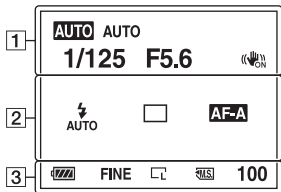

### In P/A/S/M mode

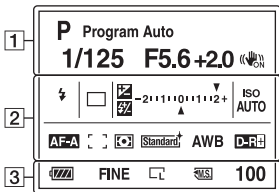

1





Display	Indication
<b>AUTO P A S M</b>	Mode dial (48 – 68)
<b>1/125</b>	Shutter speed (63)
<b>F5.6</b>	Aperture (61)
<b>+2.0</b>	Exposure (79)
	SteadyShot (46)

2

Display	Indication
	Flash mode (75)/Red-eye reduction (77)
	Exposure compensation (79)
	Flash compensation (80)
	EV scale (66, 92)
<b>ISO AUTO</b>	ISO sensitivity (82)
	Drive mode (89)

Display	Indication
<b>AF-A AF-S</b>	Focus mode (72)
<b>AF-C MF</b>	
	AF area (73)
	Metering mode (81)
	Creative Style (86)
<b>AWB</b>	White balance (Auto, Preset, Custom, Color temperature, Color filter) (83)
<b>7500K G9</b>	
<b>D-R D-R+</b>	D-Range Optimizer (86)
<b>D OFF</b>	

3

Display	Indication
	Remaining battery (16)
<b>RAW</b> <b>RAW+J</b> <b>FINE</b> <b>STD</b>	Image quality (109)
 	Image size (108)/Aspect ratio (108)
 	Memory card (20)
<b>100</b>	Remaining number of recordable images (27)

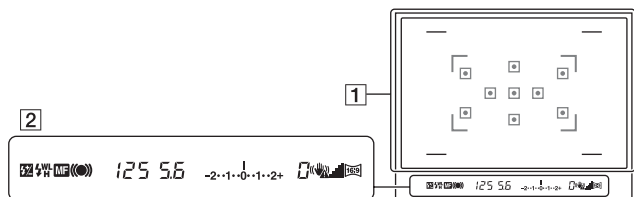

1

Display	Indication
	AF area (73)
	Shooting area for aspect ratio 16:9 (108)

2

Display	Indication
	Flash compensation (80)
	Flash charging (75)
<b>WL</b>	Wireless flash (78)
<b>H</b>	High-speed sync*
<b>MF</b>	Manual focus (74)
	Focus
<b>125</b>	Shutter speed (63)
<b>5.6</b>	Aperture (61)
<b>-2..1..0..1..2+</b>	EV scale (66, 92)
<b>0</b>	“Shooting unavailable” warning (89)
	Camera shake warning (46)
	SteadyShot scale (46)
	Aspect ratio 16:9 (108)

\* When using the HVL-F58AM/HVL-F42AM Flash (sold separately), you can shoot with the High-speed sync feature at any shutter speed. For details, refer to the operating instructions supplied with the flash.



# Selecting a function/setting

You can select a function for shooting or playback from the menu list. To display the menu list, press the control button, Fn (Function) button, or MENU button.

Example: When the Fn button is pressed.

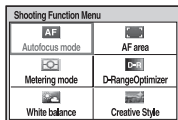

From the menu list, use the control button to move the cursor to the setting of your choice and execute the selection.

◀▶: Press ▲/▼/◀/▶ on the control button to move the cursor.

●: Press the center button to execute the selection.

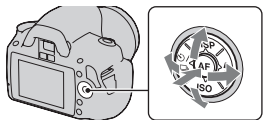

In this Instruction Manual, the process of selecting a function with the control button from the menu list is described as follows:

## Example: Fn button → [White balance] → Select the desired setting

When you start an operation, an operation guide of control button functions will be displayed at the bottom of the screen. Please refer to the guide when operating the camera. The step-by-step description of the above example is as follows:

### 1 Press the Fn button.

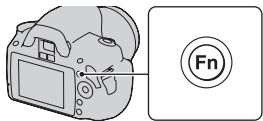

**2** Select [White balance] with ▲/▼/◀/▶ on the control button, then press the center ● to execute.

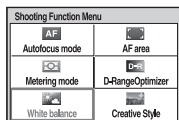

**3** Following the operation guide, select and execute the desired function.

For example, to change ☀, select ☀ with ▲/▼, adjust the value to +/- with ◀/▶, then press the center ● to execute.

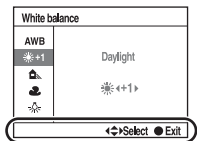

Operation guide

### The operation guide list

The operation guide also indicates operations other than the control button operation. The indications of icons are as follows.

	MENU button
	Returns with MENU button
	Fn button
	(Delete) button
	(Zoom in) button
	(Playback) button
	Control dial

### The functions selected by the Control button

Functions that will be used frequently in various shooting situations are assigned to the control button. You can set up these shooting functions directly and also switch the display status with the control button.

DISP (Display) (pages 35, 94)

⚡ (Flash) (page 75)

ISO (page 82)

⏻ / (Drive mode) (page 89)

- Single-shot adv. (page 89)

- Continuous adv. (page 89)
- Self-timer (page 90)
- Self-timer(Cont.) (page 90)
- Bracket: Cont. (page 91)
- Remote Commander (page 93)

## The functions selected by the Fn (Function) button

This button calls up the screens that are used for setting up or executing functions used frequently in shooting or viewing.

### Shooting mode

Autofocus mode (72)  
 Metering mode (81)  
 White balance (83)  
 AF area (73)  
 D-RangeOptimizer (86)  
 Creative Style (86)

### Viewing mode

Delete (102)  
 Image Index (96)  
 Specify Printing (135)  
 Slide show (97)  
 Protect (101)  
 Rotate (95)

## The functions selected by the MENU button

You can set up the basic settings for the camera as a whole or execute functions such as shooting, playback, or other operations.

### Recording menu

 1	Image size (108) Aspect ratio (108) Quality (109) Flash compens. (80) AF illuminator (77) SteadyShot (46)
---	--

 2	Color Space (88) Long exp.NR (112) High ISO NR (112)
---	--

### Custom menu



 1	Eye-Start AF (71) Ctrl dial setup (113) Red eye reduc. (77) Auto review (116) Auto off w/ VF (117)
---	--

## Playback menu

 <b>1</b>	Delete (102) Format (111) Slide show (97) Protect (101) Specify Printing (135) PlaybackDisplay (94)
---	--

## Setup menu

 <b>1</b>	LCD brightness (116) Power save (114) CTRL FOR HDMI (106) Display Color (114) Help Guide disp. (114)
---	--

 <b>2</b>	Date/Time setup (115)  Language (115) File number (110) Folder name (110) Select folder (111) • New folder (111)
--	--

 <b>3</b>	USB connection (122, 137) Audio signals (114) Cleaning mode (30) Version (118) Reset default (119)
---	--

# Shooting an image without camera shake

“Camera shake” refers to unwanted movement of the camera that occurs after the shutter button has been pressed, resulting in a blurred image. To reduce camera shake, follow the instructions below.

## Correct posture

**Stabilize your upper body and take a position that keeps the camera from moving.**

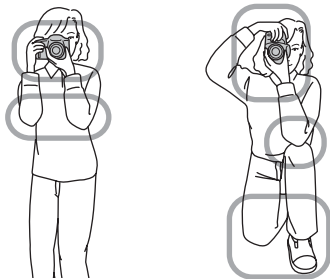

### Point ①

One hand holds the grip of the camera, and the other hand supports the lens.

### Point ②

Take a secure stance with your feet shoulder-width apart.

### Point ③

Lightly tuck your elbows against your body.

When shooting in a kneeling position, steady your upper body by placing your elbow on your knee.

## Camera shake warning indicator

Due to potential camera shake, the  (Camera shake warning) indicator flashes in the viewfinder. In this case, use a tripod or the flash.

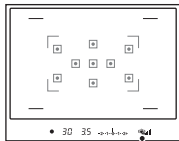

 (Camera shake warning) indicator

### Note

- The  (Camera shake warning) indicator is displayed only in the modes that automatically set the shutter speed. This indicator is not displayed in M/S modes.

## Using the SteadyShot function

This SteadyShot function can reduce the effect of camera shake by the equivalent of approximately 2.5 to 3.5 increments of shutter speed. The SteadyShot function is set to [On] in the default setting.

### The SteadyShot scale indicator

The  (SteadyShot scale) indicator shows the camera shake status. Wait until the scale becomes low, then start shooting.

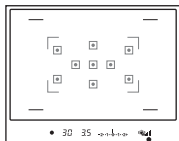

 (SteadyShot scale) indicator

### To deactivate the SteadyShot function

**MENU button** →  1 → [SteadyShot] → [Off]

### Note

- The SteadyShot function may not work optimally when the power has just been turned on or when the shutter button has been pressed all the way down without stopping halfway. Wait for the  (SteadyShot scale) indicator scale to go down, and then press the shutter button down slowly.

## Using a tripod

In the following cases, we recommend that you mount the camera on a tripod.

- Shooting without a flash under dark conditions.
- Shooting with slow shutter speeds, which are typically used in night-time shooting.
- Shooting a close subject, such as in macro shooting.
- Shooting with a telescopic lens.

### Note

- When using a tripod, deactivate the SteadyShot function because there is a potential for malfunction of the SteadyShot function (page 46).

# **AUTO/** Shooting with the automatic setting

The “AUTO” mode allows you to easily shoot any subject under any conditions because the camera makes appropriate judgments on the situation to adjust the settings.

Select  when shooting in a location where the use of a flash is restricted. When you turn the mode dial, the explanation of the selected mode and methods of shooting are displayed on the screen (Help Guide disp.). You can clear the Help Guide (page 114).

## **1 Set the mode dial to **AUTO** or (Flash Off).**

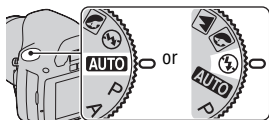

## **2 Hold the camera and look into the viewfinder.**

The subject inside the focus area comes into focus automatically (Eye-Start AF, page 71).

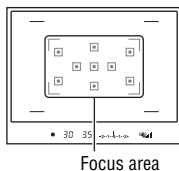

## **3 Place the desired subject within the focus area.**

- If the  (Camera shake warning) indicator flashes, carefully shoot the subject, holding the camera steady, or by using a tripod.

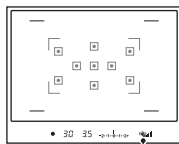

 (Camera shake warning) indicator



---

**4** When using a zoom lens, turn the zoom ring, then decide on your shot.

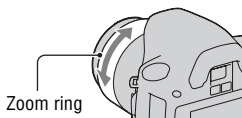

---

**5** Press the shutter button halfway down to focus.

When the focus is confirmed, ● or ● (Focus indicator) lights up (page 70).

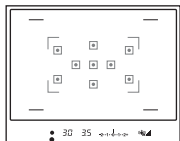
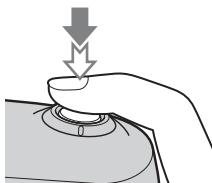



Focus indicator

---

**6** Press the shutter button fully down to shoot.

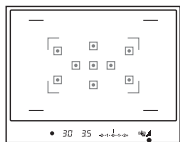
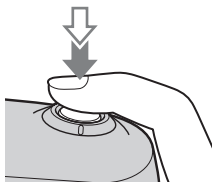
- Pressing the shutter button after the  (SteadyShot scale) indicator becomes low makes the SteadyShot function more effective.



 (SteadyShot scale) indicator

**Note**

- Since the camera turns on the automatic setting function, many features will be unavailable, such as exposure compensation, ISO setting. If you want to adjust various settings, set the mode dial to P, then shoot your subject.

# Shooting with a suitable setting for the subject (Scene Selection)

Selecting an appropriate mode for the subject or the shooting conditions allows you to shoot the image with a suitable setting for the subject.

When you turn the mode dial, the explanation of the selected mode and methods of shooting are displayed on the screen (Help Guide disp.). You can clear the Help Guide (page 114).

## Note

- The camera makes appropriate judgments on the situation to adjust the settings. Since the camera turns on the automatic setting function, many features will be unavailable, such as exposure compensation, ISO setting.



## Taking portrait photos

### This mode is suitable for

- Blurring away backgrounds and sharpening the subject.
- Expressing skin tones softly.



Set the mode dial to  (Portrait).

### Shooting techniques

- To blur the background more, set the lens to the telephoto position.
- You can shoot a vivid image by focusing on the eye that is closer to the lens.
- Use the lens hood (sold separately) to shoot backlit subjects.
- Use the red-eye reduction function if the eyes of your subject turn red from the flash (page 77).
- Set the flash mode to  (Flash Off) when you shoot without the flash (page 75).



## Taking landscape photos

### This mode is suitable for

- Shooting the entire range of scenery in sharp focus with vivid colors.



Set the mode dial to  (Landscape).

### Shooting techniques

- To accentuate the openness of the scenery, set the lens to wide angle.
- Set the flash mode to  (Fill-flash) when you shoot with the flash (page 75).



## Taking small-subject photos



### This mode is suitable for

- Shooting close subjects such as flowers, insects, dishes, or small goods.



Set the mode dial to  (Macro).

### Shooting techniques

- Get close to the subject and shoot at the minimum distance of the lens.
- You can shoot a closer subject using a macro lens (sold separately).
- Set the flash mode to  (Flash Off) when you shoot a subject within 1 m (3.3 feet).
- When shooting in macro mode, the SteadyShot function will not be fully effective. Use a tripod to achieve better results.
- Set the flash mode to  (Flash Off) when you shoot without the flash (page 75).



## Taking moving-subject photos

### This mode is suitable for

- Shooting moving subjects outdoors or in bright places.



Set the mode dial to  (Sports Action).

### Shooting techniques

- The camera shoots images continuously while the shutter button is pressed.
- Press and hold the shutter button halfway down until the right moment.
- Set the flash mode to  (Fill-flash) when you shoot with the flash (page 75).

### This mode is suitable for

- Shooting the red of the sunset beautifully.



Set the mode dial to  (Sunset).

### Shooting techniques

- Used to shoot an image accentuating the red color compared with other modes. This is also suitable for shooting the beautiful red of the sunrise.
- Set the flash mode to  (Fill-flash) when you shoot with the flash (page 75).





## Taking night view photos

### This mode is suitable for

- Shooting night scenes at a distance without losing the dark atmosphere of the surroundings.



### Set the mode dial to (Night Port./View).

Set the flash mode to  (Flash Off) when you shoot a night view without persons (page 75).

### Shooting techniques

- Take care that the subject does not move to prevent the image from blurring.
- The shutter speed is slower, so using a tripod is recommended.

### Note

- The picture may not be taken properly when shooting a wholly dark night scene.

# Shooting an image the way you want it (Exposure mode)

With a single lens reflex camera, you can adjust the shutter speed (how long the shutter is open) and aperture (the range that is in focus: depth of field) to enjoy a variety of photographic expressions.

For example, you can use a fast shutter speed to shoot the ephemeral shape of a wave, or you can accentuate a flower by opening the aperture to put everything in front of and beyond the flower out of focus. These are a few of the effects you can enjoy with your camera (pages 61, 63).

Adjusting the shutter speed and aperture not only creates the photographic effects of movement and focus, but also determines the brightness of the image by controlling the amount of exposure (the amount of light the camera takes in), which is the most important factor in photo shooting.

## Changing the brightness of the picture by the amount of exposure



Amount of exposure

low



high

When using a faster shutter speed, the camera opens the shutter for a shorter time. This means less time for the camera to take in light, resulting in a darker picture. To take a brighter picture, you can open the aperture (the hole through which the light passes) to some extent in order to adjust the amount of light the camera takes in at one time.

The brightness of the picture adjusted by the shutter speed and aperture is called “exposure.”

This section will show you how to adjust the exposure and enjoy various photo expressions by the use of movement, focus, and light. You can find out the right way to shoot the image and the subject you like.

When you turn the mode dial, the explanation of the selected mode and methods of shooting are displayed on the screen (Help Guide disp.). You can clear the Help Guide (page 114).

## P Shooting with program auto

### This mode is suitable for

- Using the automatic exposure, while keeping the custom settings for ISO sensitivity, Creative Style, D-Range optimizer, etc.



---

### 1 Set the mode dial to P.

---

### 2 Set the shooting functions to your desired settings (pages 69 to 93).

- Set the flash mode to  (Fill-flash) when you shoot with the flash (page 75).

---

### 3 Adjust the focus and shoot the subject.

---

## A Shooting by controlling the blur of the background (Aperture priority)

### This mode is suitable for

- Putting the subject in sharp focus and blur everything in front of and beyond the subject. Opening the aperture narrows the range that is in focus. (Depth of field becomes shallower.)
- Shooting the depth of the scenery. Narrowing down the aperture widens the range that is in focus. (Depth of field becomes deeper.)



### 1 Set the mode dial to A.

## 2 Select the aperture value (F-number) with the control dial.

- Smaller F-number: The foreground and background of the subject are blurred. Larger F-number: The subject and its foreground and background are all in focus.
- You cannot check the blurring of an image in the viewfinder. Check the recorded image and adjust the aperture.

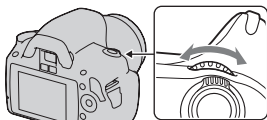

Aperture (F-number)

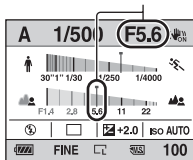

## 3 Adjust the focus and shoot the subject.

The shutter speed is automatically adjusted to obtain correct exposure.

- When the camera judges that the proper exposure is not obtained with the selected aperture value, the shutter speed flashes. In such cases, adjust the aperture again.

Shutter speed

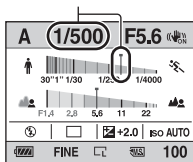

### Shooting techniques

- The shutter speed may become slower depending on the aperture value. When the shutter speed is slower, use a tripod.
- To blur the background more, use a telephoto lens or a lens that is equipped with a smaller diaphragm (bright lens).
- Set the flash mode to  (Fill-flash) when you shoot with the flash (page 75). However, the flash range differs according to the aperture value. When you shoot with the flash, check the flash range (page 77).

## S Shooting a moving subject with various expressions (Shutter speed priority)

### This mode is suitable for

- Shooting a moving subject at a moment in time. Use a faster shutter speed to crisply shoot an instant of the movement.
- Tracing the movement to express the dynamism and flow. Use a slower shutter speed to shoot a trailing image of the moving subject.



### 1 Set the mode dial to S.

## 2 Select the shutter speed with the control dial.

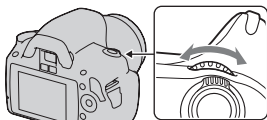

Shutter speed

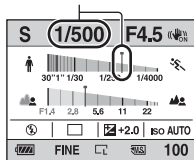

## 3 Adjust the focus and shoot the subject.

The aperture is automatically adjusted to obtain correct exposure.

- When the camera judges that the proper exposure is not obtained with the selected shutter speed, the aperture value flashes. In such cases, adjust the shutter speed again.

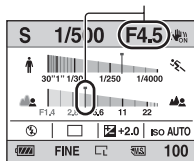

Aperture (F-number)



### Shooting techniques

- When the shutter speed is slower, use a tripod.
- When shooting an indoor sport, select a higher ISO sensitivity.

### Notes

- The  (Camera shake warning) indicator is not indicated in shutter speed priority mode.
- The higher the ISO sensitivity, the more conspicuous the noise.
- When the shutter speed is one second or more, noise reduction (Long exp.NR) will be done after shooting. You cannot do any further shooting during the reduction.
- Set the flash mode to  (Fill-flash) when you shoot with the flash (page 75).  
However, when using the flash, if you close the aperture (a larger F-number) by making the shutter speed slower, the light of the flash will not reach distant subjects.



## M Shooting with the exposure adjusted manually (Manual exposure)

### This mode is suitable for

- Shooting with the desired exposure setting by adjusting both the shutter speed and aperture.



### 1 Set the mode dial to M.

### 2 Rotate the control dial to adjust the shutter speed, and while pressing the button, rotate the control dial to adjust the aperture.

- You can select the item the control dial adjusts (shutter speed or aperture) with [Ctrl dial setup] (page 113).

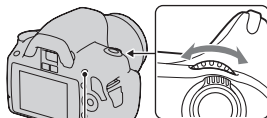

 button

Shutter speed

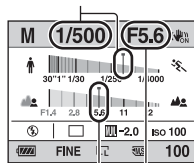

Aperture (F-number)

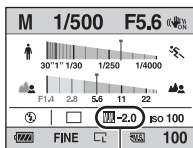

### 3 Shoot the image after the exposure is set.

- Toward +: Images become brighter.  
Toward -: Images become darker.
-  : Metered Manual





Exposure value

#### Notes

- The  (Camera shake warning) indicator is not indicated in manual exposure mode.
- When the mode dial is set to M, the ISO setting [AUTO] is set to [100]. In M mode, the ISO setting [AUTO] is not available. Set the ISO sensitivity as necessary (page 82).
- Set the flash mode to  (Fill-flash) when you shoot with the flash (page 75). However, the flash range differs according to the aperture value. When you shoot with the flash, check the flash range (page 77).

#### The EV scale in M mode

You can confirm the exposure value on the EV scale on the Standard Display or on the screen of the viewfinder.

The   arrow appears if the set exposure is beyond the range of the EV scale. The arrow starts flashing if the difference becomes greater.

LCD monitor (Standard Display)



Standard value

Viewfinder

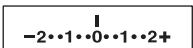

Standard value

## M Shooting trails with long exposure (BULB)

### This mode is suitable for

- Shooting trails of light, such as fireworks.
- Shooting trails of stars.



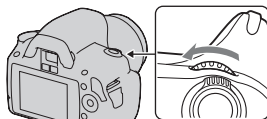

**1** Set the mode dial to M.

**2** Rotate the control dial to the left until [BULB] is indicated.

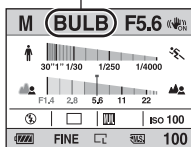

BULB



**3** While pressing the  button, rotate the control dial to adjust the aperture (F-number).

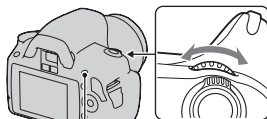

 button

---

## 4 Press the shutter button halfway down to adjust the focus.

---

## 5 Press and hold the shutter button for the duration of the shooting.

As long as the shutter button is pressed, the shutter remains open.

---

### Shooting techniques

- Use a tripod.
- Set the focus to infinity in manual focus mode when shooting fireworks, etc.
- Use the wireless Remote Commander (sold separately) (page 93).  
Pressing the SHUTTER button on the Remote Commander triggers BULB shooting and pressing it again stops BULB shooting. You do not need to press and hold the SHUTTER button on the Remote Commander.

### Notes

- When using a tripod, turn off the SteadyShot function (page 46).
- The longer the exposure time, the more conspicuous the noise on the image.
- After shooting, noise reduction (Long exp.NR) will be done for the same amount of time that the shutter was open. You cannot do any further shooting during the reduction.

# Selecting the focus method

There are two methods for adjusting the focus: autofocus and manual focus. Depending on the lens, the method for switching between the auto focus and manual focus is different.

The type of lens	The switch to be used	To switch to auto focus	To switch to manual focus
The lens is equipped with a focus mode switch	Lens (Always set the focus mode switch on the camera to AF.)	Set the focus mode switch on the lens to AF.	Set the focus mode switch on the lens to MF.
The lens is not equipped with a focus mode switch	Camera	Set the focus mode switch on the camera to AF.	Set the focus mode switch on the camera to MF.

## Using autofocus

- 1 Set the focus mode switch on the camera to AF.**

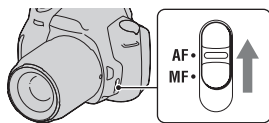

- 2 When the lens is equipped with the focus mode switch, set it to AF.**

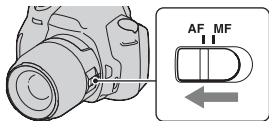

- 3 Look into the viewfinder.**

The subject inside the focus area comes into focus automatically (Eye-Start AF).

## 4 Press the shutter button halfway down to check the focus and shoot the image.

- When the focus is confirmed, the focus indicator changes to ● or (●) (below).
- The sensor used for focusing in the AF area illuminated in red (page 73).

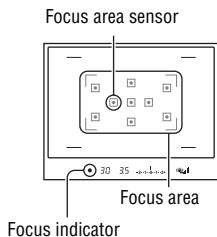

### Shooting technique

- To select the area used for focusing, set up [AF area] (page 73).

### Focus indicator

Focus indicator	Status
● lit	Focus locked. Ready to shoot.
(●) lit	Focus is confirmed. Focal point moves following a moving subject. Ready to shoot.
(C) lit	Still focusing. You cannot release the shutter.
● flashing	Cannot focus. The shutter is locked.

### Subjects that may require special focusing

Using the autofocus, it is hard to focus on the following subjects. In such cases, use the focus lock shooting feature (page 71) or manual focus (page 74).

- A subject that is low in contrast, such as blue sky or a white wall.
- Two subjects at different distances overlapping in the AF area.
- A subject that is composed of repeating patterns, such as the facade of a building.
- A subject that is very bright or glittering, such as the sun, the body of an automobile, or the surface of water.
- Ambient light is not sufficient.

## To measure the exact distance to the subject

The  $\ominus$  mark located on the top of the camera shows the location of the image sensor\*. When you measure the exact distance between the camera and the subject, refer to the position of the horizontal line.

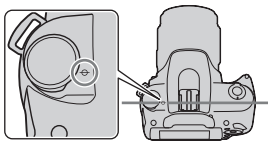

\* The image sensor is the part of the camera that acts as the film.

### Notes

- If the subject is closer than the minimum shooting distance of the attached lens, the focus cannot be confirmed. Make sure you put enough distance between the subject and the camera.
- When the focus mode switch on the camera is set to MF, the correct focus is not achieved, even if the focus mode switch on the lens is set to AF. To switch to auto focus, set the focus mode switch on the camera to AF.

## To deactivate the Eye-Start AF function

**MENU button** → **⚙ 1** → **[Eye-Start AF]** → **[Off]**

- When attaching the FDA-M1AM Magnifier (sold separately) or the FDA-A1AM Angle Finder (sold separately) to the camera, setting [Eye-Start AF] to [Off] is recommended because the eyepiece sensors located below the viewfinder may be activated.

## Shooting with your desired composition (Focus-lock)

- 1 Place the subject within the AF area and press the shutter button halfway down.**

The focus and exposure are fixed.



**2** Keep the shutter button halfway down, and put the subject back in the original position to re-compose the shot.

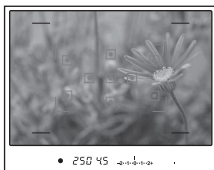

**3** Press the shutter button fully down to take the picture.

Selecting the focus method to suit the movement of the subject (Autofocus mode)

**Fn button** → [Autofocus mode] → **Select the desired setting**







<b>AF-S (Single-shot AF)</b>	The camera focuses and the focus is locked when you press the shutter button halfway down.
<b>AF-A (Automatic AF)</b>	The [Autofocus mode] is switched between Single-shot AF and Continuous AF according to the movement of the subject. When you press and hold the shutter button halfway down, if the subject is motionless, the focus is locked and if the subject is in motion, the camera continues to focus.
<b>AF-C (Continuous AF)</b>	The camera continues to focus while the shutter button is pressed and held halfway down. <ul style="list-style-type: none"><li>• The audio signals will not sound when the subject is in focus.</li></ul>

### Shooting techniques

- Use **AF-S** (Single-shot AF) when the subject is motionless.
- Use **AF-C** (Continuous AF) when the subject is in motion.



## Note



- **AF-A** (Automatic AF) is selected when the exposure mode is set to AUTO or one of the following Scene Selection modes:  (Portrait),  (Landscape),  (Sunset), or  (Night Port./View).
- **AF-S** (Single-shot AF) is selected when the exposure mode is set to  (Macro) in Scene Selection.
- **AF-C** (Continuous AF) is selected when the exposure mode is set to  (Sports Action) in Scene Selection.

## Selecting the focus area (AF area)

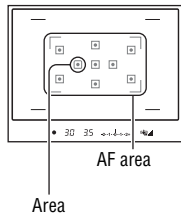
Select the desired AF area to suit the shooting conditions or your preference. The area used for focusing is illuminated briefly.



## Fn button → [AF area] → Select the desired setting

 (Wide)	The camera determines which of the nine AF areas is used in focusing within the AF area. If you press and hold the center of the control button, you can adjust the focus using the AF areas located in the center area.
 (Spot)	The camera uses the AF area located in the center area exclusively.
 (Local)	Choose the area for which you want to activate the focus from among nine areas with the control button. If you press and hold the center of the control button during the shooting, you can temporarily adjust the focus using the AF areas located in the center area.

## Notes

- When the exposure mode is set to AUTO or Scene Selection, [AF area] is fixed to  (Wide) and you cannot select the other settings.
- The AF area may not be illuminated during continuous shooting or when the shutter button is pressed all the way down without pause.

## Adjusting the focus manually (Manual focus)

When it is difficult to get the proper focus in autofocus mode, you can adjust the focus manually.

- 1 Set the focus mode switch on the lens to MF.**

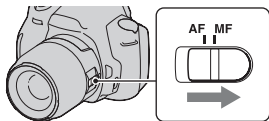

- 2 When the lens is not equipped with the focus mode switch, set the focus mode switch on the camera to MF.**

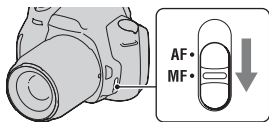

- 3 Rotate the focusing ring of the lens to achieve a sharp focus.**

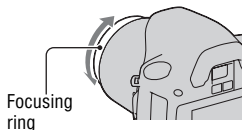

### Notes

- In the case of a subject that can be focused in autofocus mode, the ● indicator lights up in the viewfinder when the focus is confirmed. When the Wide AF area is used, the center area is used, and when the Local AF area is used, the area that is selected with the control button is used.
- When using a tele converter (sold separately), etc., rotation of the focusing ring may not be smooth.
- The correct focus in the viewfinder is not achieved if the diopter is not adjusted properly (page 24).
- The direct manual focus function is not available on this camera.

# Using the flash

In a dark location, using the flash allows you to shoot the subject brightly, and it also helps to prevent camera shake. When shooting into the sun, you can use the flash to shoot a bright image of the backlit subject.

When the mode dial is set to AUTO, the flash pops up automatically if it is dark or you are shooting into the light.

## 1 ⚡ on the control button → Select the desired setting

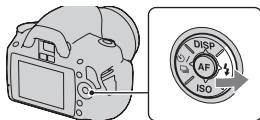

## 2 After the flash has finished charging, shoot the subject.

**⚡ Flashing:** The flash is being charged.





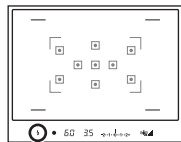

When the indicator flashes, you cannot release the shutter.

**⚡ Lit:** The flash has been charged and is ready to fire.

- When you press the shutter button halfway down under dark lighting in autofocus mode, the flash may be fired to help focus on a subject (AF illuminator).





⚡ (Flash charging) indicator

 <b>(Flash Off)</b>	Does not fire even if it is dark.
 <b>(Autoflash)</b>	Fires if it is dark or against light.
 <b>(Fill-flash)</b>	Fires every time you trigger the shutter.
 <b>(Slow sync.)</b>	Fires every time you trigger the shutter. Slow sync shooting allows you to shoot a clear image of both the subject and the background by slowing the shutter speed.
 <b>(Rear sync.)</b>	Fires right before the exposure is completed everytime you trigger the shutter.
 <b>(Wireless)</b>	Fires an external flash (sold separately) that is off the camera and away from it (Wireless flash shooting).

### Shooting techniques

- The lens hood (sold separately) may block the light of the flash. Remove the lens hood when using the flash.
- When using the flash, shoot the subject at a distance of 1 m (3.3 feet) or greater.
- When shooting indoors or shooting nightscapes, you can use slow sync to shoot a brighter image of people and backgrounds.
- You can use rear sync to shoot a natural image of the trail of a moving subject such as a moving bicycle or a walking person.

### Notes



- Do not hold the camera by grabbing the flash emitter.
- Shooting conditions required to prevent shadows from appearing on an image vary, depending on the lens.
- When the exposure mode is set to AUTO or Scene Selection, the  (Slow sync.),  (Rear sync.), and  (Wireless) items cannot be selected.

## The flash range

The range of the built-in flash depends on the ISO sensitivity and aperture value. Refer to the following table.

Aperture		F2.8	F4.0	F5.6
ISO setting	AUTO	1.4 – 7.1 m (4.6 – 23 feet)	1 – 5 m (3.3 – 16 feet)	1 – 3.6 m (3.3 – 11 feet)
	100	1 – 3.6 m (3.3 – 11 feet)	1 – 2.5 m (3.3 – 8.2 feet)	1 – 1.8 m (3.3 – 5.9 feet)
	200	1 – 5.1 m (3.3 – 16 feet)	1 – 3.5 m (3.3 – 11 feet)	1 – 2.5 m (3.3 – 8.2 feet)
	400	1.4 – 7.1 m (4.6 – 23 feet)	1 – 5 m (3.3 – 16 feet)	1 – 3.6 m (3.3 – 11 feet)
	800	2 – 10 m (6.6 – 32 feet)	1.4 – 7.1 m (4.6 – 23 feet)	1 – 5.1 m (3.3 – 16 feet)
	1600	2.8 – 14 m (9.2 – 46 feet)	2 – 10 m (6.6 – 32 feet)	1.4 – 7.1 m (4.6 – 23 feet)
	3200	4 – 20 m (13 – 66 feet)	2.8 – 14 m (9.2 – 46 feet)	2 – 10 m (6.6 – 32 feet)

## The AF illuminator

- AF illuminator does not operate when [Autofocus mode] is set to **AF-C** (Continuous AF) or the subject is moving in **AF-A** (Automatic AF). (The  or  indicator lights.)
- The AF illuminator may not operate with focal lengths of 300 mm or longer.
- When an external flash is attached, the AF illuminator of the external flash is used.

## To deactivate the AF illuminator

**MENU button** →  **1** → [AF illuminator] → [Off]

## To use the red-eye reduction

The red-eye reduction reduces the red-eye phenomenon by providing pre-flash (low-flash light) a few times before shooting when using the flash.

**MENU button** →  **1** → [Red eye reduc.] → [On]

## Performing wireless flash shooting

With an external wireless flash (sold separately), you can shoot with the flash without a cord when the external flash is not attached to the camera. By changing the position of the flash, you can shoot an image with a three dimensional feel by highlighting the contrast of light and shadow on the subject.

For the actual steps of shooting, refer to the operating instructions of the flash.

---

### 1 Attach the wireless flash to the accessory shoe and turn both the camera and the flash on.

---

### 2 on the control button → (Wireless)

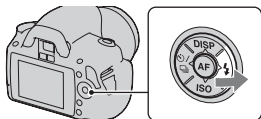

---

### 3 Remove the wireless flash from the accessory shoe.

---

#### Notes

- The camera cannot perform a pre-flash test of the wireless flash. Confirm that the flash fires properly by releasing the shutter.
- The camera cannot carry out the wireless lighting ratio control.
- Turn off the wireless flash mode after wireless flash shooting. If the built-in flash is used while the wireless flash mode is still active, inaccurate flash exposures will result.
- Change the channel of the external flash when another photographer is using a wireless flash nearby and his/her built-in flash light causes your external flash to fire. To change the channel of the external flash, refer to the operating instructions supplied with it.

# Adjusting the brightness of the image (Exposure, Flash compensation, Metering)

## Using brightness compensation for the entire image (Exposure compensation)

Except for recording mode M, the exposure is automatically selected (Automatic exposure).

Based on the exposure acquired by the automatic exposure, you can perform exposure compensation by shifting the exposure to either the + side or the - side, depending on your preference. You can make the entire image brighter by shifting to the + side. The entire image becomes darker when you shift it to the - side.

Adjust in the -  
direction



Base exposure



Adjust in the +  
direction



- 1 Press the  button to display the exposure compensation screen.

 button



- 2 Adjust the exposure with the control dial.

Toward + (over): Brightens an image.

Toward - (under): Darkens an image.

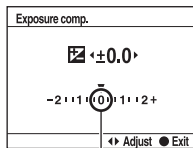

Standard exposure

---

## 3 Adjust the focus and shoot the subject.

---

### Shooting techniques

- Adjust the compensation level by checking the recorded image.
- Using bracket shooting, you can shoot multiple images with the exposure shifted to the plus or minus sides (page 91).

#### Note

- This item cannot be set when the exposure mode is set to AUTO or Scene Selection.

### Adjusting the amount of flash light (Flash compensation)

When shooting with the flash, you can adjust the amount of flash light alone, without changing the exposure compensation. You can only change the exposure of a main subject which is within the flash range.

#### **MENU button** → **1** → **[Flash compens.]** → **Select the desired setting**

Toward +: Makes the flash level higher.

Toward -: Makes the flash level lower.

#### Notes

- This item cannot be set when the exposure mode is set to AUTO or Scene Selection.
- If you have adjusted the flash level,  appears in the viewfinder when the built-in flash is pulled up. When you adjust it, be careful not to forget to reset the value.
- The higher flash effect may not be visible due to the limited amount of flash light, if the subject is outside the maximum range of the flash. If the subject is very close, the lower flash effect may not be visible.

#### **Exposure compensation and flash compensation**

Exposure compensation changes the shutter speed, aperture, and ISO sensitivity (when [AUTO] is selected) to perform the compensation. If the flash is used, the amount of flash light is also changed.

However, flash compensation only changes the amount of flash light.



## Selecting the method for measuring the brightness of a subject (Metering mode)

**Fn button → [Metering mode] → Select the desired mode**

<input checked="" type="checkbox"/> <b>(Multi segment)</b>	This mode measures light on each area after dividing the total area into multiple areas and determines the proper exposure of the entire screen.
<input checked="" type="checkbox"/> <b>(Center weighted)</b>	While emphasizing the central area of the screen, this mode measures the average brightness of the entire screen.
<input type="checkbox"/> <b>(Spot)</b>	This mode measures light at or around the focus area located in the center of the frame.

### Shooting technique

- Use  (Multi segment) metering for general shooting.

#### Note

- When the exposure mode is set to AUTO or Scene Selection, [Metering mode] is fixed to  (Multi segment) and you cannot select other modes.

# Setting ISO

Sensitivity to light is expressed by the ISO number (recommended exposure index). The larger the number, the higher the sensitivity.

---

## 1 Press ISO on the control button to display the ISO screen.

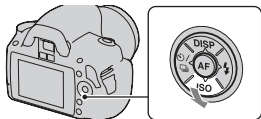

---

## 2 Select the desired value with ▲/▼ on the control button.

- The larger the number, the higher the noise level.





---

### Notes

- When the exposure mode is set to AUTO or Scene Selection, ISO is fixed to AUTO and you cannot select other ISO numbers.
- When the exposure mode is set to P/A/S and ISO is set to [AUTO], ISO is automatically set between ISO 100 and ISO 400.
- The [AUTO] setting is not provided in recording mode M. If you change the recording mode to M with the [AUTO] setting, it is switched to [100]. Set the ISO according to your shooting conditions.

# Adjusting the color tones (White balance)

The color tone of the subject changes depending on the characteristics of the light source. The table below shows how the color tone changes based on various light sources, compared with a subject that appears white under the sunlight.

Weather/lighting	Daylight	Cloudy	Fluorescent	Incandescent
				
Characteristics of light	White	Bluish	Green-tinged	Reddish

White balance is a feature that adjusts the color tone to approximate what you see. Use this feature when the color tone of the image did not come out as you expected, or when you want to change the color tone on purpose for photographic expression.







## Notes

- When the exposure mode is set to AUTO or Scene Selection, [White balance] is fixed to AWB (Auto WB) and you cannot select other modes.
- If the only light source available is a mercury lamp or a sodium lamp, the camera will not be able to acquire the accurate white balance because of the characteristics of the light source. Use the flash in such cases.

## Adjusting the white balance to suit a specific light source (Auto/Preset white balance)

### **Fn button** → **[White balance]** → **Select the desired setting**

- When [AWB] is not selected, you can fine tune the color tone with ◀▶ on the control button. Adjusting it toward + turns the image reddish and adjusting it toward – turns the image bluish.

<b>AWB (Auto WB)</b>	The camera automatically detects a light source and adjusts the color tones.
 <b>(Daylight)</b>	If you select an option to suit a specific light source, the color tones are adjusted for the light source (preset white balance).
 <b>(Shade)</b>	
 <b>(Cloudy)</b>	
 <b>(Tungsten)</b>	
 <b>(Fluorescent)</b>	
 <b>(Flash)</b>	

### Shooting technique

- When you select  (Custom), you can register your setting (below).

### Registering the color tones (Custom white balance)

In a scene where the ambient light consists of multiple types of light source, use of custom white balance is recommended in order to accurately reproduce the whiteness.

---

**1** Fn button → [White balance] → 

---

**2** Select [ SET] with ◀/▶ on the control button, then press the center of the control button.

---

**3** Hold the camera so that the white area fully covers the focus area located in the center, and then press the shutter button down.

The shutter clicks and the calibrated values (ColorTemperature and Color filter) are displayed.

---

## 4 Press the center of the control button.

The monitor returns to the recording information display with the memorized custom white balance setting retained.

- The custom white balance setting registered in this operation is effective until a new setting is registered.

---

### Note

- The message “Custom WB error” indicates that the value is beyond the expected range. (When the flash is used on a subject in close proximity or a subject with a bright color is in the frame.) If you register this value, the  indicator turns yellow on the recording information display on the LCD monitor. You can shoot at this point, but it is recommended that you set the white balance again to get a more correct white balance value.

### To call the custom white balance setting

**Fn button** → [White balance] →  (Custom)



### Note

- If the flash is used when the shutter button is pressed, a custom white balance is registered with the flash light taken into account. Take pictures with the flash in later shootings.











# Image processing

## Correcting the brightness of the image (D-Range Optimizer)

**Fn button → [D-RangeOptimizer] → Select the desired setting**

 <b>(Off)</b>	No optimization.
 <b>(Standard)</b>	When there is a sharp contrast of light and shadow between the subject and the background, which is common when shooting into the sun, the camera attenuates the contrast across the entire image to produce an image with proper brightness and contrast.
 <b>(Advanced)</b>	By dividing the image into small areas, the camera analyses the contrast of light and shadow between the subject and the background, producing the image with the optimal brightness and gradation.







### Notes



-  (Advanced) is selected when the exposure mode is set to AUTO or one of the following Scene Selection modes:  (Portrait),  (Landscape) or  (Macro).
-  (Standard) is selected when the exposure mode is set to  (Sports Action) in Scene Selection.
-  (Off) is selected when the exposure mode is set to  (Sunset) or  (Night Port./View) in Scene Selection.
- For enlarged RAW images, the effects of the D-Range optimizer other than  (Standard) cannot be checked on the camera.
- When shooting with the D-Range optimizer, the image may be noisy.



## Selecting your desired image processing (Creative Style)

**1 Fn button → [Creative Style] → Select the desired setting**



**2 When you want to adjust  (Contrast),  (Saturation), or  (Sharpness), select the desired item with / , then adjust the value with / .**

 <b>(Standard)</b>	For shooting various scenes with rich gradation and beautiful colors.
 <b>(Vivid)</b>	The saturation and contrast are heightened for shooting striking images of colorful scenes and subjects such as flowers, spring greenery, blue sky, or ocean views.
 <b>(Portrait)</b>	For shooting the skin color in a soft tone, ideally suited to shooting portraits.
 <b>(Landscape)</b>	The saturation, contrast, and sharpness are heightened for shooting vivid and crisp scenery. Distant landscapes also stand out more.
 <b>(Night view)</b>	The contrast is attenuated for shooting a nightscape that is more faithful to the real view.
 <b>(Sunset)</b>	For shooting the beautiful red of the setting sun.
 <b>(B/W)</b>	For shooting images in black and white monotone.

 (Contrast),  (Saturation), and  (Sharpness) can be adjusted for each Creative Style item.

 <b>(Contrast)</b>	The higher the value selected, the more the difference of light and shadow is accentuated, thus making an impact on an image.
 <b>(Saturation)</b>	The higher the value selected, the more vivid the color. When a lower value is selected, the color of the image is restrained and subdued.
 <b>(Sharpness)</b>	Adjusts the sharpness. The higher the value selected, the more the contours are accentuated, and the lower the value selected, the more the contours are softened.

### Notes

- When the exposure mode is set to AUTO or Scene Selection, [Creative Style] is fixed to  (Standard) and you cannot select other settings.
- When  (B/W) is selected, you cannot adjust the saturation.

## Changing the range of color reproduction (Color Space)

The way colors are represented with combinations of numbers or the range of color reproduction is called “color space.” You can change the color space, depending on your purpose.

**MENU button** →  **2** → **[Color Space]** → **Select the desired setting**

<b>sRGB</b>	This is the standard color space of the digital camera. Use sRGB in normal shooting, such as when you intend to print out the images without any modification.
<b>Adobe RGB</b>	This has a wide range of color reproduction. When a large part of the subject is vivid green or red, Adobe RGB is effective. <ul style="list-style-type: none"><li>• The file name of the image starts with “_DSC.”</li></ul>

### Notes

- Adobe RGB is for applications or printers that support color management and DCF2.0 option color space. Using some applications or printers that do not support them may result in or print images that do not faithfully reproduce the color.
- When displaying images that were recorded with Adobe RGB on the camera or non-Adobe RGB-compliant devices, the images are displayed with low saturation.



## / **Selecting the drive mode**

This camera has five drive modes, such as single-shot advanced, and continuous advanced. Use them to suit your purpose.

### Shooting single shot

This mode is for normal shooting.

 /  **on the control button** →   
**(Single-shot adv.)**

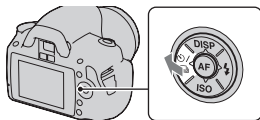



#### Note

- When the exposure mode is set to  (Sports Action) in Scene Selection, you cannot shoot single shot.

### Shooting continuously

The camera records the images continuously at a maximum of 2.5 images per second\*.

\* Our measurement conditions. The speed of continuous shooting is slower, depending on shooting conditions.

**1**  /  **on the control button** →  
 **(Continuous adv.)**

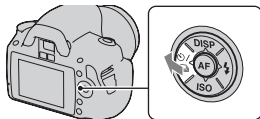

### **2** Adjust the focus and shoot the subject.

- When you press and hold the shutter button, the recording continues.

## The maximum number of continuous shots

The number of continuous shooting images obtainable has an upper limit.

<b>Fine/Standard</b>	No limit (Until the memory card is full)
<b>RAW &amp; JPEG</b>	3 images
<b>RAW</b>	6 images



### Notes

- You cannot shoot images continuously when “0” flashes in the viewfinder. Wait until the indicator disappears.
- When the exposure mode is set to a Scene Selection mode other than  (Sports Action), you cannot shoot continuously.
- The speed of continuous shooting may be slower when the battery level is insufficient or at low ambient temperatures.

## Using the self-timer

The 10-second self-timer is convenient when the photographer appears in a photo and the 2-second self-timer is convenient to reduce the camera shake. [Self-timer(Cont.)] is convenient to prevent failure because the camera continuously shoots either three or five images after a 10 second pause.

### 1 / on the control button → (Self-timer) → Select the desired setting

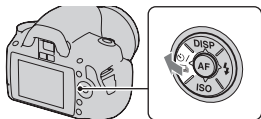

- The number after  is the number of seconds that is currently selected.
- Select  to use the continuous self-timer.



### 2 Adjust the focus and shoot the subject.

- When the self-timer is activated, audio signals and the self-timer lamp indicate the condition. The self-timer lamp flashes quickly and the audio signal sounds quickly right before the shooting.

### To cancel the self-timer

Press  /  on the control button.

## Note

- When you press the shutter button without looking into the viewfinder, use the eyepiece cover (page 26).

## Shooting images with the exposure shifted (Exposure bracket)



Base exposure



- direction



+ direction

Bracket shooting allows you to shoot several images, each with different degrees of exposure. This camera is equipped with an auto bracket function. Specify the value of deviation (steps) from the base exposure, and the camera shoots while automatically shifting the exposure. You can choose an image that has the brightness you like after shooting is finished. When the flash is fired, flash bracket shooting is used to shift the amount of flash light. To shoot, press the shutter button shot by shot.

- 1 on the control button → **BRK C (Bracket: Cont.)** → Select the desired bracket step

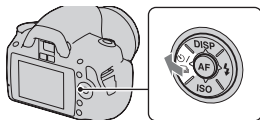

## 2 Adjust the focus and shoot the subject.

The base exposure is set at the first shot in the bracket.



<b>BRK C</b> * (Bracket: Cont.)	Shoots three images with the exposure shifted by a selected step. Press and hold the shutter button until the recording stops. When the flash is fired, press the shutter button shot by shot.
---------------------------------	--

\* \_ EV displayed with **BRK C** is the step currently selected.

## Notes

- When the mode dial is set to M, the exposure is shifted by adjusting the shutter speed.
- When you adjust the exposure, the exposure is shifted based on the compensated value.
- The bracket cannot be used when the recording mode is set to AUTO or Scene Selection.

## The EV scale in bracket shooting

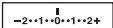
	Ambient light* bracket 0.3 steps, three shots Exposure compensation 0	Flash bracket 0.7 steps, three shots Flash compensation -1.0
LCD monitor (Standard Display)	 Shown in the top row.	 Shown in the bottom row.
Viewfinder		

\* Ambient light: Any light other than the flash light that shines on the scene for an extended period of time, such as natural light, a light bulb, or a fluorescent light.

- In bracket shooting, the same number of indices as the number of recordable images is displayed on the EV scale. However, in flash bracket shooting, the indices are not displayed in the viewfinder.
- When the bracket shooting starts, the indices that indicate already recorded images start to disappear one by one.
- If the shutter button is pressed halfway down and released, “br 1” appears. “Fbr 1” appears for the flash bracket. When flash bracket shooting starts, it indicates what number the next frame is, for instance, “Fbr 2,” “Fbr 3.”

## Shooting with the Remote Commander

You can shoot using the SHUTTER and 2SEC (the shutter is released after 2 seconds) buttons on the RMT-DSLR1 Wireless Remote Commander (sold separately). Also, refer to the operating instructions supplied with the Wireless Remote Commander.

- 1**  on the control button →   
**(Remote Commander)**

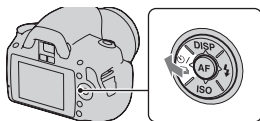

- 2** Focus on the subject, point the transmitter of the Remote Commander to the remote sensor, and shoot the image.

### Note

- Use the eyepiece cover (page 26).

# Playing back images

The last recorded image is displayed on the LCD monitor.

**1** Press the  button.



 button

**2** Select an image with /  on the control button.

**To return to the shooting mode**

Press the  button again.

**To switch the recording data display**

Press DISP on the control button.

Each time you press DISP on the control button, the screen changes as follows.

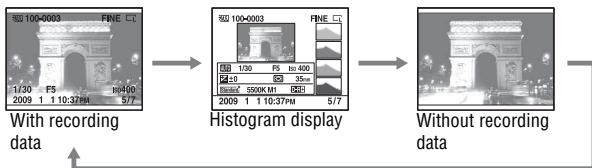

**To select the orientation when playing back an image recorded in the portrait position**

**MENU button** →  **1** → **[PlaybackDisplay]** → **Select the desired setting**

## Note

- When you play back the image on a TV or a computer, the image will be displayed in the portrait position even if [Manual rotate] is selected.

## Rotating an image

### 1 Fn button → [Rotate]

### 2 Press the center of the control button.

The image is rotated counter-clockwise. When you want to do another rotation, repeat step 2.

- Once you rotate the image, the image is played back in the rotated position, even if you turn off the power.

### To return to the normal playback screen

Press the  button.

#### Note

- When you copy rotated images to a computer, “PMB” contained on the CD-ROM (supplied) can display the rotated images correctly. However, the images may not be rotated depending on the software.

## Enlarging images

An image can be enlarged for closer examination. This is convenient to check the focus condition of a recorded image.

### 1 Display the image you want to enlarge, then press the button.

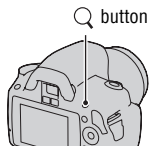

### 2 Zoom the image in or out with the control dial.

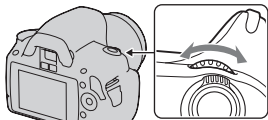

---

### 3 Select the portion you want to enlarge with ▲/▼/◀/▶ on the control button.

---

#### To cancel the enlarged playback

Press the  button so that the image returns to the normal size.

#### Scaling range

The scaling range is as follows.

Image size	Scaling range
L	Approx. $\times 1.1$ – $\times 12$
M	Approx. $\times 1.1$ – $\times 9.1$
S	Approx. $\times 1.1$ – $\times 6.1$

### Switching to the display of the image list

#### Fn button → [Image Index] → Select the desired number of images to be displayed

The screen changes to the image index screen.

#### To return to the single-image screen

Press the center of the control button when you select the desired image.

#### To select a folder

- ① Select the folder bar with ◀/▶ on the control button, then press the center.
- ② Select the desired folder with ▲/▼, then press the center.



Folder bar



## Playing back images automatically (Slide show)

The slide show can be operated either using the Fn button or the MENU button. Here operation using the Fn button is described.

### **Fn button → [Slide show] → [OK]**

Plays back recorded images in order (Slide show). The slide show automatically stops after all the images have been played back.

- You can view the previous/next image with ◀/▶ on the control button.

### **To pause the slide show**

Press the center of the control button. Pressing again starts the slide show again.

### **To end in the middle of the slide show**

Press the ▶ button.

### **To choose the interval between the images in slide show**

**Fn button → [Slide show] → [Interval] → Select the desired number of seconds**

### **To play back repeatedly**

**Fn button → [Slide show] → [Repeat] → [On]**

# Checking the information of recorded images

Each time you press DISP on the control button, the information display changes (page 94).

## Basic information display

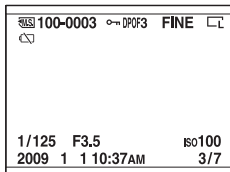

Display	Indication
	Memory card (20)
<b>100-0003</b>	Folder - file number (127)
	Protect (101)
<b>DPOF3</b>	DPOF set (135)
<b>RAW</b> <b>RAW+J</b> <b>FINE</b> <b>STD</b>	Image quality (109)
	Image size (108)/Aspect ratio (108)
	Remaining battery warning (16)
<b>1/125</b>	Shutter speed (63)
<b>F3.5</b>	Aperture (61)
<b>ISO100</b>	ISO sensitivity (82)
<b>2009 1 1</b> <b>10:37AM</b>	Date of recording
<b>3/7</b>	File number/total number of images

# Histogram display

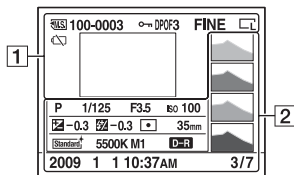

1

Display	Indication
	Memory card (20)
<b>100-0003</b>	Folder - file number (127)
	Protect (101)
<b>DPOF3</b>	DPOF set (135)
<b>RAW</b> <b>RAW+J</b> <b>FINE</b> <b>STD</b>	Image quality (109)
	Image size (108)/Aspect ratio (108)
	Remaining battery warning (16)

2

Display	Indication
	Histogram (100)
<b>AUTO P A S M</b>  	Mode dial (48 – 68)
<b>1/125</b>	Shutter speed (63)
<b>F3.5</b>	Aperture (61)
<b>ISO100</b>	ISO sensitivity (82)
<b>-0.3</b>	Exposure compensation (79)

Display	Indication
<b>-0.3</b>	Flash compensation (80)
	Metering mode (81)
<b>35mm</b>	Focal length (142)
 	Creative Style (86)
<b>AWB</b> <b>+1</b> <b>5500K M1</b>	White balance (Auto, Preset, Color temperature, Color filter) (83)
 	D-Range Optimizer (86)
<b>2009 1 1</b> <b>10:37AM</b>	Date of recording
<b>3/7</b>	File number/total number of images

## How to check the histogram

The histogram displays the luminance distribution that shows how many pixels of a particular brightness exist in the picture. To display the histogram, press DISP on the control button (page 94).

When the image has a high-key or low-key portion, that portion is flashed on the histogram display (Luminance limit warning).

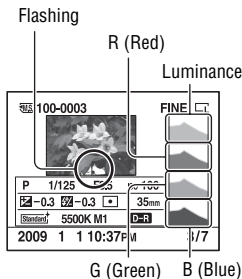
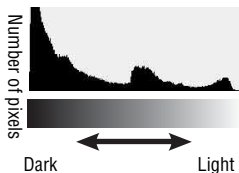

The exposure compensation will change the histogram accordingly. The right illustration is an example.

Shooting with the exposure compensation on the positive side brightens the whole picture, making the entire histogram shift to the bright side (right side). If the exposure compensation is applied on the negative side, the histogram will shift to the other side. Both ends of the histogram show a high-key or low-key portion. It is impossible to restore these area with a computer later. Adjust the exposure if necessary and shoot again.



# Protecting images (Protect)

You can protect images against accidental erasure.

The protect function can be operated either using the Fn button or the MENU button. Here operation using the Fn button is described.

Protecting selected images/canceling the protection of the selected images

**1** Fn button → [Protect] → [Marked images]

**2** Select the image you want to protect with ◀/▶ on the control button, then press the center of the control button.

A  mark appears on the selected image.

- To cancel a selection, press the center again.

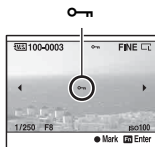

**3** To protect other images, repeat step 2.

**4** Press the Fn button.

**5** Select [OK] with ▲ on the control button, then press the center of the control button.

Protecting all the images/canceling the protection of all the images

Fn button → [Protect] → [All images] or [Cancel all] → [OK]

# Deleting images (Delete)

Once you have deleted an image, you cannot restore it. Check whether to delete the image or not beforehand.

The delete function can be operated either from the Fn button or from the MENU button. Here operation using the Fn button is described.

## Note

- Protected images cannot be deleted.

## Deleting the image that is currently displayed

- 1 Display the image you want to delete and press the  button.

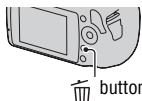

- 2 Select [Delete] with  $\blacktriangle$ , then press the center of the control button.

## Deleting the selected images

- 1 Fn button  $\rightarrow$  [Delete]  $\rightarrow$  [Marked images]

- 2 Select the images you want to delete with the control button, then press the center of the control button.

A  mark appears on the selected image.

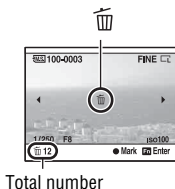

- 3 To delete other images, repeat step 2.

---

**4** Press the Fn button.

---

**5** Select [Delete] with ▲ on the control button, then press the center of the control button.

---

### Deleting all the images in the folder

**1** Fn button → [Image Index] → Select the desired number of images

---

**2** Select the folder bar with ◀ on the control button.

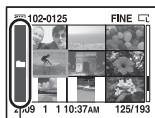

Folder bar

**3** Press the center of the control button, then select the folder you want to delete with ▲/▼.

---

**4** Press the  button.

---

**5** Select [Delete] with ▲, then press the center of the control button.

---

### Deleting all the images all at once

Fn button → [Delete] → [All images] → [Delete]

#### Note

- It may take a long time to delete a lot of images by selecting [All images]. It is recommended that you delete images on a computer or format the memory card using the camera.

# Viewing images on a TV screen

To view images recorded on the camera on a TV set, an HDMI cable (sold separately) and an HD TV equipped with an HDMI connector are required.

## 1 Turn off both your camera and the TV, and connect the camera to the TV.

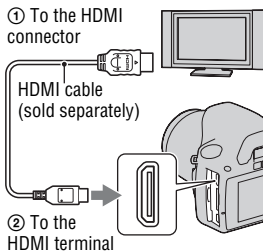

## 2 Turn on the TV and switch the input.

- See also the operating instructions supplied with the TV.

## 3 Turn on the camera.

Images shot with the camera appear on the TV screen.

Select the desired image with ◀/▶ on the control button.

- The LCD monitor on the camera does not turn on.

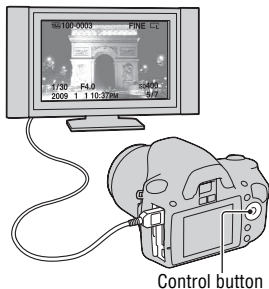

### Notes

- Use an HDMI cable with the HDMI logo.
- Use an HDMI mini connector on one end (for the camera), and a connector suitable for connection to your TV on the other end.



- By connecting your camera to Sony's VIDEO-A compatible TV using an HDMI cable, the TV automatically selects the appropriate image quality for viewing still pictures. Please refer to the operating instructions of Sony's VIDEO-A compatible TV for more details.
- Some devices may not work properly.
- Do not connect the output connector of the device with the HDMI terminal on the camera. This may cause a malfunction.

### On "PhotoTV HD"

This camera is compatible with the "PhotoTV HD" standard.

By connecting Sony's PhotoTV HD-compatible devices using an HDMI cable, a whole new world of photos can be enjoyed in breathtaking Full HD quality.

"PhotoTV HD" allows for a highly-detailed, photo-like expression of subtle textures and colors.

### To use your camera abroad

The camera automatically detects the color system to match that of the connected video device.

### On TV color systems

If you want to view images on a TV screen, you need a TV with a video input jack and the video cable. The color system of the TV must match that of your digital still camera. Check the following lists for the TV color system of the country or region where the camera is used.

#### NTSC system

Bahama Islands, Bolivia, Canada, Central America, Chile, Colombia, Ecuador, Jamaica, Japan, Korea, Mexico, Peru, Surinam, Taiwan, the Philippines, the U.S.A., Venezuela, etc.

#### PAL system

Australia, Austria, Belgium, China, Czech Republic, Denmark, Finland, Germany, Holland, Hong Kong, Hungary, Italy, Kuwait, Malaysia, New Zealand, Norway, Poland, Portugal, Singapore, Slovak Republic, Spain, Sweden, Switzerland, Thailand, United Kingdom, etc.

#### PAL-M system

Brazil

## **PAL-N system**

Argentina, Paraguay, Uruguay

## **SECAM system**

Bulgaria, France, Guiana, Iran, Iraq, Monaco, Russia, Ukraine, etc.

## Using “BRAVIA” Sync

By connecting the camera to a TV that supports “BRAVIA” Sync using an HDMI cable, you can operate the camera with the TV Remote Control.

### **1 Connect a TV that supports “BRAVIA” Sync to the camera (page 104).**

The input is automatically switched and the image shot with the camera appears on the TV screen.

### **2 Press the LINK MENU button on the TV Remote Control.**

### **3 Operate with the control button on the TV Remote Control.**

#### **The items for Link Menu**

<b>Delete</b>	Selects the method for deleting images from single or all images (page 102).
<b>Image Index</b>	Switches to the image index screen.
<b>Slide show</b>	Plays back images automatically (page 97).
<b>Protect</b>	Protects all the images/cancels the protections of all the images (page 101).
<b>Specify Printing</b>	Specifies/unspecifies DPOF on all the images (page 135). Specifies the number of images to be printed. Dates images or not.
<b>Single-image playback</b>	Returns to the single-image screen.

#### **Notes**

- The operations available are restricted when the camera is connected to a TV using an HDMI cable.
- Only TVs that support “BRAVIA” Sync can provide these operations. For details, refer to the operating instructions supplied with the TV.

- If the camera performs unnecessary operations in response to the TV Remote Control when the camera is connected to another manufacturer's TV using an HDMI connection, set [CTRL FOR HDMI] in the  Setup menu to [Off].

# Setting image size and image quality

## Image size

**MENU button** →  **1** → **[Image size]** → **Select the desired size**

**[Aspect ratio]: [3:2]**

<b>L:10M</b>	3872 × 2592 pixels
<b>M:5.6M</b>	2896 × 1936 pixels
<b>S:2.5M</b>	1920 × 1280 pixels

**[Aspect ratio]: [16:9]**

<b>L:8.4M</b>	3872 × 2176 pixels
<b>M:4.7M</b>	2896 × 1632 pixels
<b>S:2.1M</b>	1920 × 1088 pixels

### Note

- When you select a RAW image with [Quality], the image size of the RAW image corresponds to L. This size is not displayed on the LCD monitor.

## Aspect ratio

**MENU button** →  **1** → **[Aspect ratio]** → **Select the desired ratio**

<b>3:2</b>	A normal ratio.
<b>16:9</b>	An HDTV ratio.

**MENU button** →  **1** → **[Quality]** → **Select the desired setting**

<b>RAW (RAW)</b>	File format: RAW (raw data) This format does not perform any digital processing on the images. Select this format to process images on a computer for professional purposes. • The image size is fixed to the maximum size. The image size is not displayed on the LCD monitor.
<b>RAW+J (RAW &amp; JPEG)</b>	File format: RAW (raw data) + JPEG A RAW image and a JPEG image are created at the same time. This is suitable when you need two image files, a JPEG for viewing, and a RAW for editing. • The image quality is fixed to [Fine] and the image size is fixed to [L].
<b>FINE (Fine)</b>	File format: JPEG
<b>STD (Standard)</b>	The image is compressed in the JPEG format when recorded. Since the compression rate of <b>STD</b> (Standard) is higher than that of <b>FINE</b> (Fine), the file size of <b>STD</b> is smaller than that of <b>FINE</b> . This will allow more files to be recorded on one memory card, but the image quality will be lower.

### Note

- For details on the number of images that can be taken when the image quality is changed, see page 27.

### About RAW images

You need the “Image Data Converter SR” software included on the CD-ROM (supplied) in order to open a RAW image recorded on this camera. With this software, a RAW image can be opened and converted to a common format, such as JPEG or TIFF, and its white balance, color saturation, contrast, etc., can be readjusted.

- The RAW format image cannot be printed using a DPOF (print) designated printer or a PictBridge compliant printer.
- You cannot verify the effects of D-Range Optimizer other than those of **D-R** (Standard) if you play back and enlarge an image recorded in RAW format.

# Setting the method for recording on a memory card

Selecting the method for assigning file numbers to images

**MENU button** →  **2** → **[File number]** → **Select the desired setting**

<b>Series</b>	The camera does not reset numbers and assigns numbers to files in sequence until the number reaches “9999.”
<b>Reset</b>	The camera resets numbers in the following cases and assigns numbers to files from “0001.” When the recording folder contains a file, a number one higher than the largest number is assigned. <ul style="list-style-type: none"><li>– When the folder format is changed.</li><li>– When all the images in the folder are deleted.</li><li>– When the memory card is replaced.</li><li>– When the memory card is formatted.</li></ul>

Selecting the folder name format

The recorded images are stored in automatically-created folders in the DCIM folder of the memory card.

**MENU button** →  **2** → **[Folder name]** → **Select the desired setting**

<b>Standard form</b>	The folder name format is as follows: folder number + MSDCF. Example: 100MSDCF
<b>Date form</b>	The folder name format is as follows: folder number + Y (the last digit)/MM/DD. Example: 10090405 (Folder name: 100, date: 04/05/2009)

## Creating a new folder

You can create a folder in a memory card for recording images. A new folder is created with a number incremented one higher than the largest number currently used, and the folder becomes the current recording folder.

**MENU button** →  **2** → **[New folder]**

## Selecting the recording folder

When a standard form folder is selected and there are two or more folders, you can select the recording folder to be used to record images.

**MENU button** →  **2** → **[Select folder]** → **Select the desired folder**

### Note

- You cannot select the folder when you select the setting [Date form].

## Formatting the memory card

Note that formatting irrevocably erases all data on a memory card, including protected images.

**MENU button** →  **1** → **[Format]** → **[OK]**

### Notes

- During the format, the access lamp lights up. Do not eject the memory card while the lamp is lit.
- Format the memory card using the camera. If you format it on a computer, the memory card may not be usable with the camera, depending on the format type used.
- Formatting may take several minutes depending on the memory card.

# Changing the noise reduction setting

## Disabling the noise reduction during long exposure shootings

When you set the shutter speed to a second or longer (Long exposure shooting), noise reduction is turned on for the same duration that the shutter is open.

This is to reduce the grainy noise typical in a long exposure. When noise reduction is in progress, a message appears and you cannot take another picture. Select [On] to prioritize the image quality. Select [Off] to prioritize the timing of shooting.

**MENU button** →  2 → [Long exp.NR] → [Off]

### Notes

- Noise reduction is not performed on continuous shooting, continuous bracketing, or continuous self-timer images even when it is set to [On].
- When the exposure mode is set to AUTO or Scene Selection, you cannot turn off noise reduction.

## Disabling the noise reduction at high ISO sensitivity settings

When shooting with the ISO set at 1600 or above, the camera reduces the noise that becomes more noticeable when the camera sensitivity is high. Select [On] to prioritize the image quality. Select [Off] to prioritize the timing of shooting.

**MENU button** →  2 → [High ISO NR] → [Off]

### Notes

- Noise reduction is not performed on continuous shooting, continuous bracketing, or continuous self-timer images even when it is set to [On].
- When the exposure mode is set to AUTO or Scene Selection, you cannot turn off noise reduction.



# Changing the functions of the control dial

## Changing the function of the control dial

When the recording mode is M (Manual exposure), you can set the camera so that the adjustable item (the shutter speed or the aperture value) can be selected using only the control dial.

It is convenient if you select the most commonly-used item when adjusting the exposure.

**MENU button** → **⚙ 1** → **[Ctrl dial setup]** → **Select the desired setting**

# Changing other settings

## Setting the sound on/off

Selects the sound produced when the shutter is locked, during self-timer countdown, etc.

**MENU button** →  **3** → **[Audio signals]** → **Select the desired setting**

## Selecting the background color of the screen display

You can select the background color of the LCD monitor from [Black], [White], [Brown], or [Pink].

**MENU button** →  **1** → **[Display Color]** → **Select the desired setting**

## Removing the Help Guide from the screen

You can turn off the Help Guide that is displayed when you operate the camera. This is convenient when you want to perform the next operation quickly.

**MENU button** →  **1** → **[Help Guide disp.]** → **[Off]**

## Setting the time to turn the camera to the power save mode

You can set different time intervals for the camera to switch to power save mode (Power save). Pressing the shutter button halfway down returns the camera to the shooting mode.

**MENU button** →  **1** → **[Power save]** → **Select the desired time**

### Note

- Regardless of the setting here, the camera turns to power save mode after 30 minutes when the camera is connected to a TV or the drive mode is set to  (Remote Commander).

## Setting the date

Resets the date. See page 23 for details.

**MENU button** →  **2** → **[Date/Time setup]** → **Set up the date and time**

## Selecting the language

**MENU button** →  **2** → **[A Language]** → **Select the language**

# Setting the LCD monitor

Setting the brightness of the LCD monitor manually

**MENU button** →  **1** → **[LCD brightness]** → **Select the desired setting**

Setting the displayed time of the image right after shooting (Auto review)

You can check the recorded image on the LCD monitor right after the shooting. You can change the displayed time.

**MENU button** →  **1** → **[Auto review]** → **Select the desired setting**

## Note

- In auto review, the image will not be displayed in the vertical position even if [PlaybackDisplay] is set to [Auto rotate] (page 94).

## Keeping the LCD monitor tuned on while looking into the viewfinder

In the default setting, while looking into the viewfinder, the LCD monitor is turned off to prevent the battery pack from wearing down.

If you want to turn on the LCD monitor while looking into the viewfinder, select [Off].

**MENU button** →  **1** → **[Auto off w/ VF]** → **[Off]**

# Confirming the version of the camera

## Displaying the version

Displays the version of your camera. Confirm the version when a firmware update is released.

**MENU button** →  **3** → **[Version]**

### Note

- An update can be performed only when the battery level is  (three remaining battery icons) or more. We recommend that you use a sufficient battery or the AC-PW10AM AC Adaptor (sold separately).

# Resetting to the default

You can reset the main functions of the camera.

**MENU button** →  **3** → **[Reset default]** → **[OK]**

The items to be reset are as follows.

Items	Reset to
Exposure compensation (79)	±0.0
Recording information display (35)	Graphic Display
Playback display (94)	Single-image screen (with recording information)
Drive mode (89)	Single-shot adv.
ISO (82)	AUTO
Flash mode (75)	Autoflash or Flash Off
Metering mode (81)	Multi segment
Autofocus mode (72)	AF-A
White balance (83)	AWB (Auto white balance)
Custom white balance (84)	5500K
D-RangeOptimizer (86)	Standard
Creative Style (86)	Standard

## Recording menu

Items	Reset to
Image size (108)	L:10M
Aspect ratio (108)	3:2
Quality (109)	Fine
Flash compens. (80)	±0.0
AF illuminator (77)	Auto
Long exp.NR (112)	On
High ISO NR (112)	On

## Custom menu

Items	Reset to
Eye-Start AF (71)	On
Ctrl dial setup (113)	Shutter speed
Red eye reduc. (77)	Off
Auto review (116)	2 sec
Auto off w/ VF (117)	On

## Playback menu

Items	Reset to
Specify Printing – Date imprint (139)	Off
Slide show – Interval (97)	3 sec
Slide show – Repeat (97)	Off
PlaybackDisplay (94)	Auto rotate

## Setup menu

Items	Reset to
LCD brightness (116)	±0
Power save (114)	10 sec
CTRL FOR HDMI (106)	On
Display Color (114)	White
Help Guide disp. (114)	On
File number (110)	Series
Folder name (110)	Standard form
USB connection (122, 138)	Mass Storage
Audio signals (114)	On



# Copying images to your computer

This section describes how to copy images in a memory card to a computer connected using a USB cable.

## Recommended computer environment

The following environment is recommended for a computer connected to the camera to import images.

### ■ Windows

OS (pre-installed): Microsoft Windows 2000 Professional SP4/ Windows XP\*<sup>1</sup> SP3/Windows Vista\*<sup>2</sup> SP1

- Operation is not assured in an environment based on an upgrade of the operating systems described above or in a multi-boot environment.

\*1 64-bit editions and Starter (Edition) are not supported.

\*2 Starter (Edition) is not supported.

USB jack: Provided as standard

### ■ Macintosh

OS (pre-installed): Mac OS X (v10.1.3 – v10.5)

USB jack: Provided as standard

### Notes on connecting your camera to a computer

- Operations are not guaranteed for all the recommended computer environments mentioned above.
- If you connect two or more USB devices to a single computer at the same time, some devices, including your camera, may not operate, depending on the types of USB devices you are using.
- Operations are not guaranteed when using a USB hub or an extension cable.
- Connecting your camera using a USB interface that is compatible with Hi-Speed USB (USB 2.0 compliant) allows advanced transfer (high speed transfer) as this camera is compatible with Hi-Speed USB (USB 2.0 compliant).
- When your computer resumes from a suspend or sleep mode, communication between your camera and your computer may not recover at the same time.

## Stage 1: Connecting the camera and your computer

**1 Insert a memory card with recorded images into the camera.**

**2 Select the type of memory card you want to copy images from using the memory card switch.**

**3 Insert the sufficiently charged battery pack in the camera, or connect the camera to a wall outlet (wall socket) with the AC Adaptor (sold separately).**

- When you copy images to your computer using an insufficiently charged battery pack, copying may fail or image data may become corrupted if the battery pack shuts down too soon.

**4 Turn on the camera and the computer.**

**5 Check that [USB connection] in  3 is set to [Mass Storage].**

**6 Connect the camera and your computer.**

The AutoPlay wizard appears on the desktop.

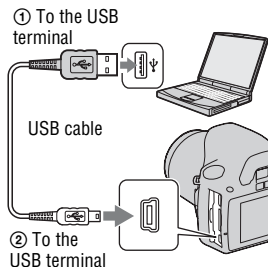

## Stage 2: Copying images to a computer

### For Windows

This section describes an example of copying images to a “Documents” (For Windows XP: “My Documents”) folder.

When you use the supplied “PMB” software, you can copy images easily (page 129).

### 1 Click [Open folder to view files] (For Windows XP: [Open folder to view files] → [OK]) as the wizard screen appears automatically on the desktop.

- When the wizard screen does not appear, click [Computer] (For Windows XP: [My Computer]) → [Removable Disk].



Open folder to view files using Windows Explorer

### 2 Double-click [DCIM].

- You can also import images directly using “PMB.”

### 3 Double-click the folder where the image files you want to copy are stored.

Then, right-click an image file to display the menu and click [Copy].

- On the storage destination of the image files, see page 127.



---

**4 Double-click the [Documents] folder. Then, right-click on the “Documents” window to display the menu and click [Paste].**

The image files are copied to the “Documents” folder.

- When an image with the same file name exists in the copy destination folder, the overwrite confirmation message appears. When you overwrite an existing image with a new one, the original file data is deleted. To copy an image file to the computer without overwriting, change the file name to a different name and then copy the image file. However, note that if you change the file name, you may not be able to play back that image with your camera (page 127).

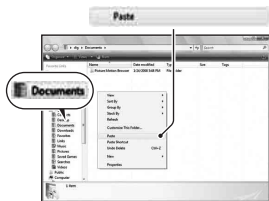

---

**For Macintosh**

---

**1 Double-click the newly recognized icon → [DCIM] → the folder where the images you want to copy are stored.**

---

**2 Drag and drop the image files to the hard disk icon.**

The image files are copied to the hard disk.

---

# Viewing images on your computer

## For Windows

This section describes the procedure for viewing copied images in the “Documents” (For Windows XP: “My Documents”) folder.

To view RAW images, the supplied “Image Data Converter SR” software is required (page 132).

### 1 Click [Start] → [Documents].

- If you are using Windows 2000, double-click [My Documents] on the desktop.



### 2 Double-click the desired image file.

The image is displayed.

## For Macintosh



**Double-click the hard disk icon → the desired image file to open the image file.**

## Deleting the USB connection

Perform each procedure for Windows or Macintosh listed below beforehand when:

- Disconnecting the USB cable.
- Removing the memory card.
- Turning off the camera.

### ■ For Windows

Double-click  on the tasktray, then click  (USB Mass Storage Device) → [Stop]. Confirm the device on the confirmation window, then click [OK].

The device is disconnected.

### ■ For Macintosh

**Drag and drop the drive icon or the icon of the memory card to the “Trash” icon.**

The camera is disconnected from the computer.

## Image file storage destinations and file names

The image files recorded with your camera are grouped as folders on the memory card.

### Example: viewing folders on Windows Vista

- A** Folders containing image data recorded using this camera. (The first three digits show the folder number.)
- B** You can create a folder in date form (page 110).
- You cannot record/play back any images in the “MISC” folder.
- Image files are named as follows. □□□□ (file number) stands for any number within the range of 0001 to 9999. The numerical portions of the name of a RAW data file and its corresponding JPEG file are the same.
  - JPEG files: DSC0□□□□.JPG
  - JPEG files (Adobe RGB):  
\_DSC□□□□.JPG
  - RAW data file (other than Adobe RGB):  
DSC0□□□□.ARW
  - RAW data file (Adobe RGB):  
\_DSC□□□□.ARW
- The extension may not be displayed depending on the computer.

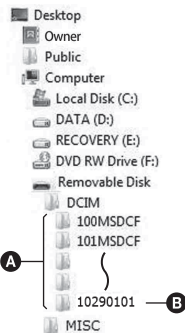

## Copying images stored on a computer to a memory card and viewing the images

This section describes the process using a Windows computer as an example. Step 1 is not necessary if the file name has not been changed. When you use the supplied “PMB” software, you can copy images easily (page 129).

---

## 1 Right-click the image file, then click [Rename]. Change the file name to “DSC0□□□□.”

- Enter a number from 0001 to 9999 for □□□□.
- If the overwrite confirmation message appears, enter a different number.
- An extension may be displayed depending on the computer settings. The extension for images is JPG. Do not change the extension.

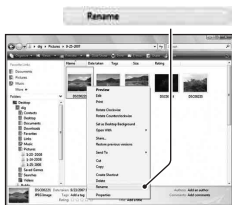

---

## 2 Copy the image file to the memory card folder in the following order.

- ① Right-click the image file, then click [Copy].
  - ② Double-click [Removable Disk] in [Computer] (For Windows XP: [My Computer]).
  - ③ Right-click the [□□□MSDCF] folder in the [DCIM] folder, then click [Paste].
- □□□ stands for any number within the range of 100 to 999.



---

### Notes

- You may be unable to play back some images depending on the image size.
- When an image file has been processed by a computer or when the image file was recorded using a model other than that of your camera, playback on your camera is not guaranteed.
- When there is no folder, first create a folder with your camera (page 111) and then copy the image file.



# Using the software

To utilize images recorded with the camera, the following software is provided:

- Sony Image Data Suite
  - “Image Data Converter SR”
  - “Image Data Lightbox SR”
- Sony Picture Utility
  - “PMB” (Picture Motion Browser)

## Note

- “PMB” is not compatible with Macintosh computers.

## Recommended computer environment

### ■ Windows

Recommended environment for using “Image Data Converter SR Ver.3”/“Image Data Lightbox SR”

OS (pre-installed): Microsoft Windows XP\*<sup>1</sup> SP3/Windows Vista\*<sup>2</sup> SP1

\*1 64-bit editions and Starter (Edition) are not supported.

\*2 Starter (Edition) is not supported.

CPU/Memory: Pentium 4 or faster is recommended, RAM 1 GB or more is recommended.

Display: 1024 × 768 dots or more

Recommended environment for using “PMB”

OS (pre-installed): Microsoft Windows XP\*<sup>1</sup> SP3/Windows Vista\*<sup>2</sup> SP1

\*1 64-bit editions and Starter (Edition) are not supported.

\*2 Starter (Edition) is not supported.

CPU/Memory: Pentium III 500 MHz or faster, 256 MB of RAM or more (Recommended: Pentium III 800 MHz or faster and 512 MB of RAM or more)

Hard Disk: Disk space required for installation—500 MB or more

Display: 1024 × 768 dots or more

## ■ Macintosh

Recommended environment for using “Image Data Converter SR Ver.3”/  
“Image Data Lightbox SR”

OS (pre-installed): Mac OS X (v10.4/v10.5)

CPU: Power PC G4/G5 series (1.0 GHz or faster is recommended)/Intel  
Core Solo/Core Duo/Core 2 Duo or faster

Memory: 1 GB or more is recommended.

Display: 1024 × 768 dots or more

## Installing the software

### ■ Windows

- Log on as Administrator.

## 1 Turn on your computer, and insert the CD-ROM (supplied) into the CD-ROM drive.

The installation menu screen appears.

- If it does not appear, double-click [Computer] (For Windows XP: [My Computer]) →  (SONYPICTUTIL) → [Install.exe].
- Under Windows Vista, the AutoPlay screen may appear. Select “Run Install.exe” and follow the instructions that appear on the screen to proceed with the installation.

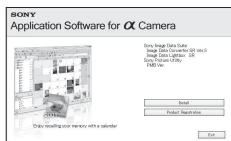

## 2 Click [Install].

- Verify that both “Sony Image Data Suite” and “Sony Picture Utility” are checked and follow the instructions on the screen.

---

### **3 Remove the CD-ROM after the installation is complete.**

The following software is installed and shortcut icons appear on the desktop.

- Sony Image Data Suite
    - “Image Data Converter SR”
    - “Image Data Lightbox SR”
  - Sony Picture Utility
    - “PMB”
    - “PMB Guide”
- 

#### **■ Macintosh**

- Log on as Administrator.
- 

### **1 Turn on your Macintosh computer, and insert the CD-ROM (supplied) into the CD-ROM drive.**

---

### **2 Double-click the CD-ROM icon.**

---

### **3 Copy the [IDS\_INST.pkg] file in the [MAC] folder to the hard disk icon.**

---

### **4 Double-click the [IDS\_INST.pkg] file in the copy-to folder.**

- Follow the instructions on the screen to complete the installation.
- 

#### **Note**

- When the restart confirmation message appears, restart the computer following the instructions on the screen.

## Using “Image Data Converter SR”

### Note

- If you save an image as RAW data, the image is saved in the ARW2.1 format.

With “Image Data Converter SR” you can:

- Edit images recorded in RAW format with various corrections, such as tone curve, and sharpness.
- Adjust images with white balance, exposure, and creative style, etc.
- Save the images displayed and edited on a computer. You can either save the image as RAW format or save it in the general file format.
- For details on “Image Data Converter SR,” refer to Help.

To start Help, click [Start] → [All Programs] → [Sony Image Data Suite] → [Help] → [Image Data Converter SR Ver.3].

### To start up/exit “Image Data Converter SR”

#### ■ Windows

Double-click the shortcut of “Image Data Converter SR Ver.3” on the desktop.

When starting up from the Start menu, click [Start] → [All Programs] → [Sony Image Data Suite] → [Image Data Converter SR Ver.3].

To exit, click the  button on the upper-right corner of the screen.

#### ■ Macintosh

Double-click [Image Data Converter SR Ver.3] in the [Sony Image Data Suite] folder from the [Applications] folder.

To exit, click a quit item from the [IDC SR] menu.

## Using “Image Data Lightbox SR”

With “Image Data Lightbox SR” you can:

- Display and compare RAW/JPEG images recorded with this camera.
- Rate the images on a scale of five.
- Set color labels and so on.
- Display an image with “Image Data Converter SR” and make adjustments to it.
- For details on “Image Data Lightbox SR,” refer to Help.

To start Help from the Start menu, click [Start] → [All Programs] → [Sony Image Data Suite] → [Help] → [Image Data Lightbox SR].

## To start up/exit “Image Data Lightbox SR”

### ■ Windows

Double-click [Image Data Lightbox SR] on the desktop.

When starting up from the Start menu, click [Start] → [All Programs] → [Sony Image Data Suite] → [Image Data Lightbox SR].

To exit, click the  button on the upper-right corner of the screen.

The dialogue used for saving a collection appears.

### ■ Macintosh

Double-click [Image Data Lightbox SR] in the [Sony Image Data Suite] folder from the [Applications] folder.

To exit, click a quit item from the [Image Data Lightbox SR] menu.

## Using “PMB”

### Note

- “PMB” is not compatible with Macintosh computers.

With “PMB” you can:

- Import images shot with the camera and display them on the computer.
- Organize images on the computer on a calendar by shooting date to view them.
- Retouch (Red Eye Correction, etc.), print, and send still images as e-mail attachments, change the shooting date and more.
- Print or save still images with the date.
- Create a data disc using a CD burner drive or DVD burner drive.
- For details on “PMB,” refer to “PMB Guide.”

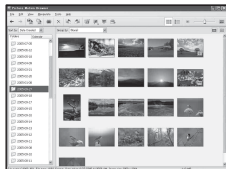

To start “PMB Guide,” double-click the shortcut of  (PMB Guide) on the desktop. When starting up from the start menu, click [Start] → [All Programs] → [Sony Picture Utility] → [Help] → [PMB Guide].

## To start up/exit “PMB”

Double-click the  (PMB) icon on the desktop.

Or, from the Start menu: Click [Start] → [All Programs] → [Sony Picture Utility] → [PMB].

To exit the “PMB,” click  button on the upper-right corner of the screen.

### Note

- The confirmation message of the Information tool appears on the screen when starting “PMB” for the first time. Select [Start]. This function informs you of news, such as software updates. You can change the setting later.

# Specifying DPOF

Using the camera, you can specify the images and the number of images to print before you print images at a shop or with your printer. Follow the procedure below.

DPOF specifications are left with images after printing. It is recommended that you unspecify them after printing.

## Specifying /unspecifying DPOF on selected images

DPOF specifications can be operated either using the Fn button or the MENU button. Here operation using the Fn button is described.

---

**1** Fn button → [Specify Printing] → [DPOF setup] → [Marked images] → [OK]

---

**2** Select the image with ◀/▶ on the control button.

---

**3** Select the number of sheets with the center of the control button.

- To unspecify DPOF, set the number to “0.”
- 

**4** Press the Fn button.

---

**5** Select [OK] with ▲ on the control button, then press the center of the control button.

---

### Notes

- You cannot specify DPOF on RAW data files.
- You can specify any number up to 9.

## Specifying/unspecifying DPOF on all the images

Fn button → [Specify Printing] → [DPOF setup] → [All images] or [Cancel all] → [OK] → [OK]

- You can select a value for the number of images to be printed after you have selected [All images]. The same value will be used for all images.

## Dating images

You can date images when printing them. The position of the date (inside or outside the image, character size, etc.) depends on your printer.

**Fn button → [Specify Printing] → [Date imprint] → [On]**

### Note

- This function may not be provided, depending on the printer.



# Printing images by connecting the camera to a PictBridge compliant printer

Even if you do not have a computer, you can print images shot using your camera by connecting the camera directly to a PictBridge compliant printer.

“PictBridge” is based on the CIPA standard. (CIPA: Camera & Imaging Products Association)



## Note

- You cannot print RAW images.

## Stage 1: Setting the camera

### Note

- It is recommended to use the AC Adaptor (sold separately) to prevent the power from turning off partway through printing.

---

**1** MENU button →  **3** → [USB connection] → [PTP]

---

**2** Turn the camera off and insert the memory card that the images have been recorded on.

---

**3** Select the type of memory card you want to print images from using the memory card switch.

---

## Stage 2: Connecting the camera to the printer

### 1 Connect the camera to the printer.

① To the  
USB terminal

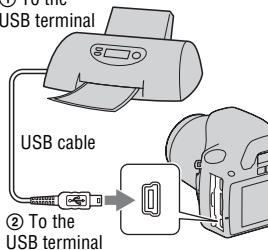

### 2 Turn on your camera and the printer.

The screen used for selecting images you want to print appears.

## Stage 3: Printing

### 1 Select the image to print with ◀/▶ on the control button, then press the center of the control button.

- To cancel, press the center again.

### 2 Repeat step 1 if you want to print other images.

### 3 Press the MENU button and set up each item.

- For details on setting items, see “PictBridge menu.”

### 4 Select [Print] → [OK] in the menu, then press the center of the control button.

The image is printed.

- After the screen indicating that the print is completed appears, press the center of the control button.

## To cancel the print

During printing, pressing the center of the control button cancels the print. Remove the USB cable or turn off the camera. When you want to print again, follow the procedure (Stages 1 to 3) above.

## PictBridge menu

### Print

Prints the selected images. For details, see “Stage 3: Printing.”

### Set print q'ty

You can specify the number of prints, up to 20. The same number of prints is specified on all the selected images.

### Paper size

Auto	Printer setup
9×13cm/3.5"×5"	89×127 mm
Hagaki	100×147 mm
10×15cm	10×15 cm
4"×6"	101.6×152.4 mm
A6/4.1"×5.8"	105×148.5 mm
13×18cm/5"×7"	127×178 mm
Letter	216×279.4 mm
A4/8.3"×11.7"	210×297 mm
A3/11.7"×16.5"	297×420 mm

### Date imprint

Day and time	Attaches the date and time.
Date	Attaches the date.
Off	Does not attach the date.

### Unmark all

After the message appears, select [OK], then press the center of the control button.  on each image is cleared after printing images. When you cancel your specification without printing images, select this item.

# Specifications

## Camera

### [System]

Camera Type	Digital Single Lens Reflex Camera with built-in flash and interchangeable lenses
Lens	All of $\alpha$ Lenses

### [Image sensor]

Total pixel number of camera	Approx. 10 800 000 pixels
Effective pixel number of camera	Approx. 10 200 000 pixels
Image format	23.6×15.8 mm (APS-C format) Interlace scan Primary Color

### [SteadyShot]

System	Image sensor-shift mechanism
SteadyShot Compensation capability	Approximately 2.5 to 3.5 EV decrease in shutter speed (varies according to shooting conditions and lens used)

### [Anti-Dust]

System	Charge protection coating on Low-Pass Filter and image sensor-shift mechanism
--------	---

### [Auto Focus System]

System	TTL phase-detection system, CCD line sensors (9 points, 8 lines with center cross-hair sensor)
--------	--

Sensitivity Range	0 to 18 EV (at ISO 100 equivalent)
-------------------	------------------------------------

AF illuminator	Approx. 1 to 5 m (3.3 to 16.4 feet)
----------------	-------------------------------------

### [Viewfinder]

Type	Fixed eye-level pentaprism-mirror
Field of View	0.95
Magnification	0.83 × with 50 mm lens at infinity, $-1 \text{ m}^{-1}$
Eye Relief	Approximately 16.5 mm from the eyepiece, 10.9 mm from the eyepiece frame at $-1$ diopter ( $-1 \text{ m}^{-1}$ )
Diopter Adjustment	$-2.5$ to $+1.0 \text{ m}^{-1}$

### [Exposure control]

Metering Cell	SPC
Metering method	40-segment honeycomb-pattern
Metering Range	1 to 20 EV (3 to 20 EV with Spot metering), (at ISO 100 with F1.4 lens)

ISO sensitivity (Recommended exposure index)	AUTO, ISO 100 to 3200
--	-----------------------

Exposure compensation	$\pm 2.0$ EV (1/3 EV step)
-----------------------	----------------------------

### [Shutter]

Type	Electronically-controlled, vertical-traverse, focal-plane type
------	--

Speed range 1/4000 second to 30 seconds, bulb, (1/3 EV step)

Flash sync speed  
1/160 second

### [Built-In-Flash]

Flash G.No.  
GN 10 (in meters at ISO 100)

Recycling time  
Approx. 4 seconds

Flash coverage  
Covering 18 mm lens (focal length that the lens indicates)

Flash compensation  
 $\pm 2.0$  EV (1/3 EV step)

### [Recording media]

“Memory Stick PRO Duo”  
media, SD memory card,  
SDHC memory card

### [LCD monitor]

LCD panel 6.7 cm (2.7 type) TFT drive

Total number of dots  
230 400 (960 × 240) dots

### [Input/output terminals]

USB miniB

HDMI HDMI type C minijack

### [Power, general]

Used battery pack  
Rechargeable battery pack  
NP-FH50

### [Others]

PictBridge Compatible

Exif Print Compatible

PRINT Image Matching III  
Compatible

Dimensions Approx. 128 × 97 × 67.5 mm (5 1/8 × 3 7/8 × 2 3/4 inches) (W/H/D, excluding protrusions)

Mass Approx. 450 g (15.9 oz) (without batteries, memory card and body accessories)

Operating temperature  
0 to 40°C (32 to 104°F)

File format JPEG (DCF Ver. 2.0, Exif Ver. 2.21, MPF Baseline) compliant, DPOF compatible

USB communication  
Hi-Speed USB (USB 2.0 compliant)

### BC-VH1 Battery charger

Input rating 100 V – 240 V AC, 50/60 Hz, 4 W

Output rating  
8.4 V DC, 0.28 A

Operating temperature range  
0 to 40°C (32 to 104°F)

Storage temperature range  
–20 to +60°C (–4 to +140°F)

Maximum dimensions  
Approx. 60 × 25 × 95 mm (2 3/8 × 1 × 3 3/4 inches) (W/H/D)

Mass Approx. 75 g (2.6 oz)

## Rechargeable battery pack NP-FH50

### Used battery

Lithium-ion battery

### Maximum voltage

DC 8.4 V

### Nominal voltage

DC 6.8 V

### Maximum charge current

1.75 A

### Maximum charge voltage

DC 8.4 V

### Capacity

Typical 6.1 Wh (900 mAh)

Minimum 5.9 Wh (870 mAh)

### Maximum dimensions

Approx. 31.8 × 18.5 × 45.0  
mm (1 5/16 × 3/4 × 1 13/16  
inches) (W/H/D)

### Mass

Approx. 50 g (1.8 oz)

Design and specifications are subject to change without notice.

## On focal length



The picture angle of this camera is narrower than that of a 35 mm-format film camera. You can find the approximate equivalent of the focal length of a 35 mm-format film camera, and shoot with the same picture angle, by increasing the focal length of your lens by half.

For example, by using a 50 mm lens, you can get the approximate equivalent of a 75 mm lens of a 35 mm-format film camera.

## On image data compatibility

- This camera conforms with DCF (Design rule for Camera File system) universal standard established by JEITA (Japan Electronics and Information Technology Industries Association).
- Playback of images recorded with your camera on other equipment and playback of images recorded or edited with other equipment on your camera are not guaranteed.

## Trademarks

- **α** is a trademark of Sony Corporation.
- “Memory Stick,” , “Memory Stick PRO,” **MEMORY STICK PRO**, “Memory Stick Duo,” **MEMORY STICK DUO**, “Memory Stick PRO Duo,” **MEMORY STICK PRO DUO**, “Memory Stick PRO-HG Duo,” **MEMORY STICK PRO-HG DUO**, “Memory Stick Micro,” “MagicGate,” and **MAGICGATE** are trademarks of Sony Corporation.
- “InfoLITHIUM” is a trademark of Sony Corporation.
- “PhotoTV HD” is a trademark of Sony Corporation.
- Microsoft, Windows, and Windows Vista are either registered trademarks or trademarks of Microsoft Corporation in the United States and/or other countries.
- HDMI, the HDMI logo and High-Definition Multimedia Interface are trademarks or registered trademarks of HDMI Licensing LLC.
- Macintosh and Mac OS are trademarks or registered trademarks of Apple Inc.
- PowerPC is a registered trademark of IBM Corporation in the United States.
- The SDHC logo is a trademark.
- MultiMediaCard is a trademark of MultiMediaCard Association.
- Intel, Intel Core, MMX, and Pentium are trademarks or registered trademarks of Intel Corporation.
- Adobe is a registered trademark or a trademark of Adobe Systems Incorporated in the United States and/or other countries.
- D-Range Optimizer Advanced uses technology provided by  Apical Limited.
- In addition, system and product names used in this manual are, in general, trademarks or registered trademarks of their respective developers or manufacturers. However, the <sup>TM</sup> or ® marks are not used in all cases in this manual.

# Troubleshooting

If you experience trouble with your camera, try the following solutions. Check the items on pages 144 to 152. Consult your Sony dealer or local authorized Sony service facility.

❶ Check the following items.

❷ Remove the battery pack, and insert the battery pack again after about one minute, and turn on the power.

❸ Reset the settings (page 119).

❹ Consult your Sony dealer or local authorized Sony service facility.

## Battery pack and power

### **The battery pack cannot be installed.**

- As you insert the battery pack, use the tip of the battery pack to push the lock lever (page 15).
- Check the model number of the battery pack (pages 11, 16).

---

### **The remaining battery indicator is incorrect, or sufficient remaining battery indicator is displayed but the power runs out too quickly.**

- This phenomenon occurs when you use the camera in an extremely hot or cold location (page 156).
- The battery pack is discharged. Install a charged battery pack (page 12).
- The battery pack is dead (page 16). Replace it with a new one.

---

### **Cannot turn on the camera.**

- Install the battery pack correctly (page 15).
- The battery pack is discharged. Install a charged battery pack (page 12).
- The battery pack is dead (page 16). Replace it with a new one.



---

### **The power turns off suddenly.**

- If you do not operate the camera for given period of time, the camera turns to power saving mode and nearly shuts down. To cancel the power save, operate the camera, such as pressing the shutter button halfway down (page 114).

---

### **The CHARGE lamp flashes when charging the battery pack.**

- Remove and re-insert the battery pack correctly.
- Charge the battery pack under the suitable temperatures between 10 and 30°C (50 and 86°F).

## Shooting images

---

### **Nothing is displayed on the LCD monitor when the power is turned on.**

- In the default setting, the LCD monitor will turn off if no operation is registered for more than 10 seconds to minimize the battery consumption.

---

### **The image is not clear in the viewfinder.**

- Adjust the diopter scale properly using the diopter-adjustment dial (page 24).

---

### **The image has not been recorded.**

- A memory card is not inserted.

---

### **The shutter does not release.**

- You are using a memory card with a write-protect switch, and the switch is set to the LOCK position. Set the switch to the recording position.
- The position of the memory card switch is wrong. Set it to the correct position (page 20).
- Check the free capacity of the memory card (page 27). If it is full, do one of the following:
  - Delete unnecessary images (page 102).
  - Change the memory card.
- You cannot record images while charging the built-in flash (page 75).
- The shutter cannot be released when the subject is out of focus.
- The lens is not attached properly. Attach the lens properly (page 18).
- When an astronomical telescope, etc., is attached to the camera, set the recording mode to M and do your shooting.

- The subject may require special focusing (page 70). Use the focus-lock or manual focus function (pages 71, 74).
- 

### **Recording takes a long time.**

- The noise reduction function is turned on (page 112). This is not a malfunction.
  - You are shooting in RAW mode (page 109). Since the RAW data file is large, the RAW mode shooting may take time.
- 

### **The image is out of focus.**

- The subject is too close. Check the minimum focal distance of the lens.
  - You are shooting in manual focus mode, set the focus mode lever to AF (autofocus) (page 69).
  - When the focus mode switch is equipped with the lens, set it to AF.
  - Ambient light is insufficient.
- 

### **Eye-Start AF does not work.**

- Set [Eye-Start AF] to [On] (page 71).
  - Press the shutter button halfway down.
- 

### **The flash does not work.**

- The flash mode is set to [Autoflash]. If you want to make sure the flash fires without fail, set the flash mode to [Fill-flash] (page 75).
- 

### **Fuzzy specks appear in images shot using the flash.**

- Dust in the air reflected the flash light and appeared in the image. This is not a malfunction.
- 

### **The flash takes too long to recharge.**

- The flash has been fired in succession in a short period. When the flash has been fired in succession, the recharging process may take longer than usual to avoid overheating of the camera.
- 

### **A picture taken with the flash is too dark.**

- If the subject is beyond the flash range (the distance that the flash can reach), the pictures will be dark because the flash light does not reach the subject. If the ISO is changed, the flash range also changes with it (page 77).

- In the following cases, the image may be dark. Remove these accessories, then shoot.
    - An ND filter or a PL filter.
    - A diffuser.
    - A wide panel for the HVL-F36AM flash.
- 

### **The date and time are recorded incorrectly.**

- Set the correct date and time (pages 23, 115).
- 

### **The aperture value and/or shutter speed flashes when you press the shutter button halfway down.**

- Since the subject is too bright or too dark, it is beyond the available range of the camera. Adjust the setting again.
- 

### **The image is whitish (Flare).**

#### **Blurring of light appears on the image (Ghosting).**

- The picture was taken under a strong light source, and excessive light has entered the lens. Attach a lens hood (sold separately).
- 

### **The corners of the picture are too dark.**

- If any filter or hood is used, take it off and try shooting again. Depending on the thickness of the filter and improper attachment of the hood, the filter or the hood may partially appear in the image. The optical properties of some lenses may cause the periphery of the image to appear too dark (insufficient light).
- 

### **The eyes of the subject come out red.**

- Activate the red eye reduction function (page 77).
  - Get close to the subject, and shoot the subject within the flash range using the flash (page 77).
- 

### **Dots appear and remain on the LCD monitor.**

- This is not a malfunction. These dots are not recorded (page 7).
- 

### **The image is blurred.**

- The picture was taken in a dark location without the flash, resulting in camera shake. The use of a tripod or the flash is recommended (pages 47, 75).

---

### **The EV scale ◀ ▶ is flashing in the viewfinder.**

- The subject is too bright or too dark for the metering range of the camera.

## Viewing images

### **Your camera cannot play back images.**

- The folder/file name has been changed on your computer (page 127).
- When an image file has been processed by a computer or when the image file was recorded using a model other than that of your camera, playback on your camera is not guaranteed.
- The camera is in USB mode. Delete the USB connection (page 125).

---

### **The image does not appear on the TV screen.**

- Check whether the connection is correct (page 104).

## Deleting/Editing images

### **Your camera cannot delete an image.**

- Cancel the protection (page 101).

---

### **You have deleted an image by mistake.**

- Once you have deleted an image, you cannot restore it. We recommend that you protect images that you do not want to delete (page 101).

---

### **You cannot mark a DPOF mark.**

- You cannot mark DPOF marks on RAW images.

## Computers

### **You do not know if the OS of your computer is compatible with the camera.**

- Check “Recommended computer environment” (pages 121, 129).

---

### **Your computer does not recognize your camera.**

- Check that the camera is turned on.
- When the battery level is low, install the charged battery pack (page 12), or use the AC Adaptor (sold separately).

- Use the USB cable (supplied) (page 122).
- Disconnect the USB cable, and connect it again firmly.
- Set [USB connection] to [Mass Storage] (page 122).
- Disconnect all equipment other than the camera, the keyboard and the mouse from the USB jacks of your computer.
- Connect the camera directly to your computer without passing through a USB hub or other device (page 121).

---

**You cannot copy images.**

- Make the USB connection by properly connecting the camera with your computer (page 122).
- Follow the designated copy procedure for your OS (page 123).
- When you shoot images with a memory card formatted by a computer, you may not be able to copy the images to a computer. Shoot using a memory card formatted by your camera (page 111).

---

**The image cannot be played back on a computer.**

- If you are using “PMB,” refer to the “PMB Guide.”
- Consult the computer or software manufacturer.

---

**After making a USB connection, “PMB” does not start automatically.**

- Make the USB connection after the computer is turned on (page 122).

---

**You do not know how to operate the software (supplied).**

- See help or the guide of each software.

## Memory card

---

**Cannot insert a memory card.**

- Insertion direction of the memory card is wrong. Insert it in the correct direction (page 20).

---

**Cannot record on a memory card.**

- The memory card is full. Delete unnecessary images (page 102).
- An unusable memory card is inserted (page 21).

---

**You have formatted a memory card by mistake.**

- All the data on the memory card is deleted by formatting. You cannot restore it.

---

**“Memory Stick PRO Duo” media are not recognized by a computer with a “Memory Stick” media slot.**

- If “Memory Stick PRO Duo” media are not supported on your computer’s “Memory Stick” media slot, connect the camera to the computer (page 122). The computer will recognize the “Memory Stick PRO Duo” media.

## Printing

Also see “PictBridge compliant printer” (as follows) in conjunction with the following items.

---

**The color of the image is strange.**

- When you print the images recorded in Adobe RGB mode using sRGB printers that are not compatible with Adobe RGB (DCF2.0/Exif2.21), the images are printed at a lower intensity level (page 88).

---

**Images are printed with both edges cut off.**

- Depending on your printer, the left, right, top, and bottom edges of the image may be cut off. Especially when you print an image shot with the aspect ratio set to [16:9], the lateral end of the image may be cut off.
- When printing images using your own printer, cancel the trimming or borderless settings. Consult the printer manufacturer as to whether the printer provides these functions or not.
- When having images printed at a digital print shop, ask the shop whether they can print the images without cutting off both edges.

---

**Cannot print images with the date.**

- Using “PMB,” you can print images with date (page 133).
- This camera does not have a feature for superimposing dates on images. However, because the images shot with the camera include information on the recording date, you can print images with the date superimposed if the printer or the software can recognize Exif information. For compatibility with Exif information, consult the manufacturer of the printer or the software.
- When you print images at a shop, images can be printed with the date if you ask them to do so.

## PictBridge compliant printer

For details, refer to the operating instructions supplied with the printer or consult with the manufacturer of the printer.

---

### **A connection cannot be established.**

- The camera cannot be connected directly to a printer that is not compliant with the PictBridge standard. Consult the printer manufacturer as to whether the printer is compliant with PictBridge or not.
- Set [USB connection] to [PTP] (page 137).
- Disconnect and connect the USB cable again. If an error message is indicated on the printer, refer to the operating instructions supplied with the printer.

---

### **Cannot print images.**

- Check that the camera and the printer are properly connected using the USB cable.
- RAW images cannot be printed.
- Images shot using cameras other than this camera or images modified with a computer may not be printed.

---

### **“---- -- --” is printed on the date-inserted part of the image.**

- Images that do not have the recording data/time information cannot be printed with the date inserted. Set [Date imprint] to [Off] and print the image again (page 139).

---

### **Cannot print the image at the size selected.**

- Disconnect the USB cable and reconnect it whenever you change the paper size after the printer has been connected to the camera.
- The print setting of the camera differs from that of the printer. Change the setting of either the camera (page 139) or the printer.

---

### **Cannot operate the camera after canceling printing.**

- Wait for a while as the printer is carrying out the cancellation. It may take some time depending on the printer.

### **The lens gets fogged.**

- Moisture condensation has occurred. Turn off the camera and leave it for about an hour before using it (page 156).

---

### **The message “Set date and time?” appears when you turn on the camera.**

- The camera has been left unused for sometime with a low battery or no battery pack. Charge the battery pack and set the date again (pages 23, 156). If the date setting is lost every time the battery pack is charged, consult your Sony dealer or local authorized Sony service facility.

---

### **The number of recordable images does not decrease or decreases two at a time.**

- This is because the compression rate and the image size after compression change depending on the image when you shoot a JPEG image (page 109).

---

### **The setting is reset without the resetting operation.**

- The battery pack was removed when the power switch was set to ON. When removing the battery pack, make sure the camera is turned off and the access lamp is not illuminated (pages 15, 34).

---

### **The camera does not work properly.**

- Turn off the camera. Remove the battery pack and insert it again. If an AC Adaptor (sold separately) is used, disconnect the power cord. If the camera is hot, allow it to cool down before trying this corrective procedure. If the camera does not work after doing these solutions, consult your Sony dealer or local authorized Sony service facility.

---

### **The five bars of the SteadyShot scale flashes.**

- The SteadyShot function does not work. You can continue to shoot but the SteadyShot function will not work. Turn the camera off and on. If the SteadyShot scale continues to flash, consult your Sony dealer or local authorized Sony service facility.

---

### **“--E-” is indicated on the screen.**

- Remove the memory card, and insert it again. If this procedure does not turn off the indication, format the memory card.



# Warning messages

If the following messages appear, follow the instructions below.

---

## Incompatible battery. Use correct model.

- An incompatible battery pack is being used (page 16).

---

## Set date and time?

- Set the date and time. If you have not used the camera for a long time, charge the internal rechargeable battery (pages 23, 156).

---

## Power insufficient

- You tried to perform [Cleaning mode] when the battery level is insufficient. Charge the battery pack or use the AC Adaptor (sold separately).

---

## Unable to use “Memory Stick.” Format?

## Unable to use SD memory card. Format?

- The memory card was formatted on a computer and the file format was modified.  
Select [OK], then format the memory card. You can use the memory card again, however, all previous data in the memory card is erased. It may take a some time to complete the format.

If the message still appears, change the memory card.

---

## Card error

- An incompatible memory card is inserted or the format has failed.

---

## Reinsert “Memory Stick.”

## Reinsert SD memory card.

- The inserted memory card cannot be used in your camera.
- The memory card is damaged.
- The terminal section of the memory card is dirty.

---

## This “Memory Stick” is not supported.

- Use “Memory Stick” media available on this camera (page 21).

---

## No “Memory Stick” inserted.

## Shutter is locked.

## No SD memory card inserted.

## Shutter is locked.

- No memory card of the type selected using the memory card switch is inserted. Insert a memory card, or change the type of the memory card using the memory card switch.

---

## Processing...

- When Long exposure noise reduction will be done for the same amount of time that the shutter was open. You cannot do any further shooting during this reduction.

---

**Unable to display.**

- Images recorded with other cameras or images modified with a computer may not be able to be displayed.

---

**No lens attached. Shutter is locked.**

- The lens is not attached properly, or the lens is not attached.
- When attaching the camera to an astronomical telescope or something similar, set the recording mode to M.

---

**No images**

- There is no image in the memory card.

---

**Image protected**

- You tried to delete protected images.

---

**Unable to print.**

- You tried to mark RAW images with a DPOF mark.

---

**Initializing USB connection...**

- A USB connection has been established. Do not disconnect the USB cable.

---

**Check the connected device.**

- A PictBridge connection cannot be established. Disconnect the USB cable and connect it again.

---

**Camera overheating. Allow it to cool.**

- The camera has become hot because you have been shooting continuously.  
Turn the power off. Cool the camera and wait until the camera is ready to shoot again.

---

**Camera error  
System error**

- Turn the power off, remove the battery pack, then re-insert it. If the message appears frequently, consult your Sony dealer or local authorized Sony service facility.

---

**Unable to magnify.****Unable to rotate image.**

- Images recorded with other cameras may not be enlarged or rotated.

---

**No images changed**

- You attempted to protect images or specified DPOF without changing the specification of those images.

---

**Cannot create more folders.**

- The folder with a name beginning with “999” exists on the memory card. You cannot create any folders if this is the case.

---

**Printing canceled**

- The print job was canceled. Disconnect the USB cable or turn the camera off.

---

**Unable to mark.**

- You attempted to mark RAW images on the PictBridge screen.

---

**Printer error**

- Check the printer.
- Check if the image you want to print is corrupted.

---

**Printer busy**

- Check the printer.

# Precautions

## Do not use/store the camera in the following places

- In an extremely hot, dry or humid place  
In places such as in a car parked in the sun, the camera body may become deformed and this may cause a malfunction.
- Under direct sunlight or near a heater  
The camera body may become discolored or deformed, and this may cause a malfunction.
- In a location subject to rocking vibration
- Near strong magnetic place
- In sandy or dusty places  
Be careful not to let sand or dust get into the camera. This may cause the camera to malfunction, and in some cases this malfunction cannot be repaired.

## On storing

Be sure to attach the lens cap or body cap when not using the camera. When attaching the body cap, remove all the dust from the cap before placing it on the camera. When you purchase the DT 18 – 55 mm F3.5 – 5.6 SAM Lens Kit, purchase the Rear Lens Cap ALC-R55 also.

## On operating temperatures

Your camera is designed for use under the temperatures between 0 and 40°C (32 and 104°F). Shooting in extremely cold or hot places that exceed this range is not recommended.

## On moisture condensation

If the camera is brought directly from a cold to a warm location, moisture may condense inside or outside the camera. This moisture condensation may cause a malfunction of the camera.

### How to prevent moisture condensation

When bringing the camera from a cold place to a warm place, seal the camera in a plastic bag and allow it to adapt to conditions at the new location over about an hour.

### If moisture condensation occurs

Turn off the camera and wait about an hour for the moisture to evaporate. Note that if you attempt to shoot with moisture remaining inside the lens, you will be unable to record clear images.

## On the internal rechargeable battery

This camera has an internal rechargeable battery for maintaining the date and time and other settings regardless of whether the power is on or off.

This rechargeable battery is continually charged as long as you are using the camera. However, if you use the camera for only short periods, it discharges gradually, and if you do not use the camera at all for about 3 months it becomes completely discharged. In this case, be sure to charge this rechargeable battery before using the camera.

However, even if this rechargeable battery is not charged, you can still use the camera as long as you do not record the date and time. If the camera resets the settings to the defaults each time you charge the battery, the internal rechargeable battery may be dead. Consult your Sony dealer or local authorized Sony service facility.

### **Charging method of the internal rechargeable battery**

Insert a charged battery pack in the camera, or connect the camera to a wall outlet (wall socket) using the AC Adaptor (sold separately), and leave the camera for 24 hours or more with the power off.

### **Notes on recording/playback**

- Before you record one-time events, make a trial recording to make sure that the camera is working correctly.
- This camera is neither dust-proof, nor splash-proof, nor water-proof.
- Do not look at the sun or a strong light through a removed lens or the viewfinder. This may cause irrecoverable damage to your eyes.

Or it may cause a malfunction of your camera.

- Do not use the camera near a location that generates strong radio waves or emits radiation. The camera may not be able to record or play back properly.
- Using the camera in sandy or dusty locations may cause malfunctions.
- If moisture condensation occurs, remove it before using the camera (page 156).
- Do not shake or strike the camera. In addition to malfunctions and an inability to record images, this may render the memory card unusable, or cause image data breakdown, damage or loss.
- Clean the flash surface before use. The heat of flash emission may cause dirt on the flash surface to become discolored or to stick to the flash surface, resulting in insufficient light emission.
- Keep the camera, supplied accessories, etc., out of the reach of children. A memory card, etc., may be swallowed. If such a problem occurs, consult a doctor immediately.

# Index

## Numerics

- 40-segment honeycomb pattern  
metering.....140

## A

- Adobe RGB .....88
- AF area .....73
- AF illuminator .....77
- Ambient light.....92
- Amount of exposure .....58
- Anti-dust function.....30
- Aperture .....58, 61
- Aperture priority .....61
- Aspect ratio.....108
- Audio signals .....114
- Auto off w/ VF .....117
- Auto review .....116
- Autoflash .....75
- Autofocus .....69
- Autofocus mode.....72

## B

- Battery pack.....12, 15
- Bracket.....91
- BULB shooting.....67

## C

- Center weighted.....81
- Charging battery pack.....12
- Cleaning mode.....30

- Color Space..... 88
- Compression ratio..... 109
- Continuous AF..... 72
- Continuous bracket ..... 91
- Continuous shooting ..... 89
- Contrast..... 86
- Control button..... 41, 42
- Creative Style..... 86
- Ctrl dial setup..... 113
- CTRL FOR HDMI..... 106
- Custom white balance..... 84

## D

- Date imprint ..... 136
- Date/Time setup..... 23, 115
- DC IN terminal ..... 34
- Delete ..... 102
- Depth of field..... 58
- Diopter-adjustment ..... 24
- Display Color..... 114
- DPOF setup..... 135
- D-Range Optimizer..... 86
- Drive mode ..... 89

## E

- Enlarged image ..... 95
- EV scale ..... 66, 92
- Exposure ..... 58
- Exposure compensation ..... 79
- Exposure mode ..... 58

Eyecup .....	26	ISO sensitivity .....	82
Eyepiece cover .....	26		
Eyepiece sensors .....	117	<b>J</b>	
Eye-Start AF .....	71	JPEG .....	109
<b>F</b>		<b>L</b>	
File number .....	110	Landscape .....	53
Fill-flash .....	75	Language .....	115
Flash bracket .....	91	LCD brightness .....	116
Flash compensation .....	80	LCD monitor .....	35, 98
Flash mode .....	75	Lens .....	18
Flash Off .....	48, 75	Long exp.NR .....	112
Fn button .....	41	<b>M</b>	
Focal length .....	142	Macro .....	54
Focus .....	69	Manual exposure .....	65
Focus indicator .....	70	Manual focus .....	74
Focus mode .....	72	Memory card switch .....	20
Focus-lock .....	71	“Memory Stick Duo” .....	20
Folder name .....	110	“Memory Stick PRO Duo” .....	20
Format .....	111	Menu .....	43
<b>H</b>		Metering mode .....	81
Help Guide disp. ....	114	Moisture condensation .....	156
High ISO NR .....	112	Multi segment .....	81
High-speed sync .....	40	<b>N</b>	
Histogram .....	100	New folder .....	111
<b>I</b>		Night Port./View .....	57
Image Data Converter SR .....	132	Noise reduction .....	112
Image Data Lightbox SR .....	132	Number of recordable images	
Image Index .....	96	.....	27, 28
Image quality .....	109		
Image size .....	108		

<b>P</b>	
PictBridge .....	137
PlaybackDisplay .....	94
PMB .....	133
Portrait .....	52
Power Save .....	114
Preset white balance .....	83
Pressing halfway down .....	49
Print .....	135, 137
Program auto .....	60
Protect .....	101
<b>Q</b>	
Quality .....	109
<b>R</b>	
RAW .....	109, 132
Rear sync. ....	75
Red eye reduc. ....	77
Reducing camera shake .....	45
Remote Commander .....	93
Reset .....	119
Rotate .....	95
<b>S</b>	
Saturation .....	86
Scene Selection .....	51
SD memory card .....	20
Select folder .....	111
Self-timer .....	90
Set the clock .....	23, 115
Sharpness .....	86
Shooting .....	48
Shoulder strap .....	25
Shutter speed .....	58, 63
Shutter speed priority .....	63
Single-shot AF .....	72
Slide show .....	97
Slow sync .....	75
Specifications .....	140
Sports Action .....	55
Spot .....	81
SteadyShot function .....	46
Sunset .....	56
<b>U</b>	
USB connection .....	122, 138
<b>V</b>	
Version .....	118
Viewfinder .....	40
Viewing image .....	94
Viewing images on a TV screen .....	104
<b>W</b>	
White balance .....	83
Wireless flash .....	78





