

SONY®

3-277-950-15 (1)

α

Preparing the camera

Before your operation

Shooting images

Using the shooting
function

Using the viewing
function

Changing your setup

Viewing images on a
computer

Printing images

Additional information on this product and answers to frequently asked questions can be found at our Customer Support Website.

<http://www.sony.net/>



Printed on 70% or more recycled paper using
VOC (Volatile Organic Compound)-free
vegetable oil based ink.

Printed in Japan



3277950150

α200

Digital Single Lens Reflex Camera
Instruction Manual

DSLR-A200



© 2008 Sony Corporation

Owner's Record

The model and serial numbers are located on the bottom.

Record the serial number in the space provided below.

Refer to these numbers whenever you call upon your Sony dealer regarding this product.

Model No. DSLR-A200

Serial No. _____

WARNING

To reduce fire or shock hazard, do not expose the unit to rain or moisture.

For Customers in the U.S.A.

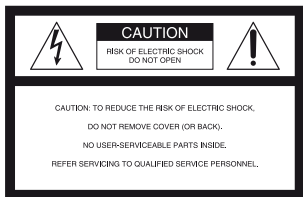

This symbol is intended to alert the user to the presence of uninsulated "dangerous voltage" within the product's enclosure that may be of sufficient magnitude to constitute a risk of electric shock to persons.



This symbol is intended to alert the user to the presence of important operating and maintenance (servicing) instructions in the literature accompanying the appliance.

IMPORTANT SAFEGUARDS

For your protection, please read these safety instructions completely before operating the appliance, and keep this manual for future reference.

Carefully observe all warnings, precautions and instructions on the appliance, or the one described in the operating instructions and adhere to them.

Use

Power Sources

This set should be operated only from the type of power source indicated on the marking label. If you are not sure of the type of electrical power supplied to your home, consult your dealer or local power company. For those sets designed to operate from battery power, or other sources, refer to the operating instructions.

Polarization

This set may be equipped with a polarized ac power cord plug (a plug having one blade wider than the other).

This plug will fit into the power outlet only one way. This is a safety feature. If you are unable to insert the plug fully into the outlet, try reversing the plug. If the plug should still fail to fit, contact your electrician to have a suitable outlet installed. Do not defeat the safety purpose of the polarized plug by forcing it in.

Overloading

Do not overload wall outlets, extension cords or convenience receptacles beyond their capacity, since this can result in fire or electric shock.

Object and Liquid Entry

Never push objects of any kind into the set through openings as they may touch dangerous voltage points or short out parts that could result in a fire or electric shock. Never spill liquid of any kind on the set.

Attachments

Do not use attachments not recommended by the manufacturer, as they may cause hazards.

Cleaning

Unplug the set from the wall outlet before cleaning or polishing it. Do not use liquid cleaners or aerosol cleaners. Use a cloth lightly dampened with water for cleaning the exterior of the set.

Installation

Water and Moisture

Do not use power-line operated sets near water – for example, near a bathtub, washbowl, kitchen sink, or laundry tub, in a wet basement, or near a swimming pool, etc.

Power-Cord Protection

Route the power cord so that it is not likely to be walked on or pinched by items placed upon or against them, paying particular attention to the plugs, receptacles, and the point where the cord exits from the appliance.

Accessories

Do not place the set on an unstable cart, stand, tripod, bracket, or table. The set may fall, causing serious injury to a child or an adult, and serious damage to the set. Use only a cart, stand, tripod, bracket, or table recommended by the manufacturer.

Ventilation

The slots and openings in the cabinet are provided for necessary ventilation. To ensure reliable operation of the set, and to protect it from overheating, these slots and openings must never be blocked or covered.

– Never cover the slots and openings with a cloth or other materials.

- Never block the slots and openings by placing the set on a bed, sofa, rug, or other similar surface.
- Never place the set in a confined space, such as a bookcase, or built-in cabinet, unless proper ventilation is provided.
- Do not place the set near or over a radiator or heat register, or where it is exposed to direct sunlight.

Lightning

For added protection for this set during a lightning storm, or when it is left unattended and unused for long periods of time, unplug it from the wall outlet and disconnect the antenna or cable system. This will prevent damage to the set due to lightning and power-line surges.

Service

Damage Requiring Service

Unplug the set from the wall outlet and refer servicing to qualified service personnel under the following conditions:

- When the power cord or plug is damaged or frayed.
- If liquid has been spilled or objects have fallen into the set.
- If the set has been exposed to rain or water.
- If the set has been subject to excessive shock by being dropped, or the cabinet has been damaged.
- If the set does not operate normally when following the operating instructions. Adjust only those controls that are specified in the operating instructions. Improper adjustment of other controls may result in damage and will often require extensive work by a qualified technician to restore the set to normal operation.
- When the set exhibits a distinct change in performance – this indicates a need for service.

Servicing

Do not attempt to service the set yourself as opening or removing covers may expose you to dangerous voltage or other hazards.

Refer all servicing to qualified service personnel.

Replacement parts

When replacement parts are required, be sure the service technician has used replacement parts specified by the manufacturer that have the same characteristics as the original parts. Unauthorized substitutions may result in fire, electric shock, or other hazards.

Safety Check

Upon completion of any service or repairs to the set, ask the service technician to perform routine safety checks (as specified by the manufacturer) to determine that the set is in safe operating condition.

Read this first

CAUTION

Replace the battery with the specified type only. Otherwise, fire or injury may result. Do not expose the batteries to excessive heat such as sunshine, fire or the like.

For Customers in the U.S.A. and Canada

RECYCLING LITHIUM-ION BATTERIES

Lithium-Ion batteries are recyclable.

You can help preserve our environment by returning your used rechargeable batteries to the collection and recycling location nearest you.



For more information regarding recycling of rechargeable batteries, call toll free 1-800-822-8837, or visit <http://www.rbrcl.org/>

Caution: Do not handle damaged or leaking Lithium-Ion batteries.

Battery pack

This device complies with Part 15 of the FCC Rules, Operation is subject to the following two conditions:

(1) This device may not cause harmful interference, and (2) this device must accept any interference received, including interference that may cause undesired operation.

This Class B digital apparatus complies with Canadian ICES-003.

For Customers in the U.S.A.

If you have any questions about this product, you may call:

Sony Customer Information Services
Center
1-800-222-SONY (7669)

The number below is for the FCC related matters only.

Regulatory Information

Declaration of Conformity
Trade Name: SONY
Model No.: DSLR-A200
Responsible Party: Sony Electronics Inc.
Address: 16530 Via Esprillo,
San Diego, CA 92127 U.S.A.
Telephone No.: 858-942-2230

This device complies with Part 15 of the FCC Rules. Operation is subject to the following two conditions: (1) This device may not cause harmful interference, and (2) this device must accept any interference received, including interference that may cause undesired operation.

CAUTION

You are cautioned that any changes or modifications not expressly approved in this manual could void your authority to operate this equipment.

Note:

This equipment has been tested and found to comply with the limits for a Class B digital device, pursuant to Part 15 of the FCC Rules.

These limits are designed to provide reasonable protection against harmful interference in a residential installation. This equipment generates, uses, and can radiate radio frequency energy and, if not installed and used in accordance with the instructions, may cause harmful interference to radio communications. However, there is no guarantee that interference will not occur in a particular installation. If this equipment does cause harmful interference to radio or television reception, which can be determined by turning the equipment off and on, the user is encouraged to try to correct the interference by one or more of the following measures:

- Reorient or relocate the receiving antenna.
- Increase the separation between the equipment and receiver.
- Connect the equipment into an outlet on a circuit different from that to which the receiver is connected.
- Consult the dealer or an experienced radio/TV technician for help.

The supplied interface cable must be used with the equipment in order to comply with the limits for a digital device pursuant to Subpart B of Part 15 of FCC Rules.

For the State of California, USA only

Perchlorate Material - special handling may apply, See

www.dtsc.ca.gov/hazardouswaste/perchlorate

Perchlorate Material: Lithium battery contains perchlorate.

For Customers in Europe

This product has been tested and found compliant with the limits set out in the EMC Directive for using connection cables shorter than 3 meters (9.8 feet).

Attention

The electromagnetic fields at the specific frequencies may influence the picture and sound of this unit.

Notice

If static electricity or electromagnetism causes data transfer to discontinue midway (fail), restart the application or disconnect and connect the communication cable (USB, etc.) again.

Disposal of Old Electrical & Electronic Equipment (Applicable in the European Union and other European countries with separate collection systems)



This symbol on the product or on its packaging indicates that this product shall not be treated as household waste. Instead it shall be handed over to the applicable collection point for the recycling of electrical and electronic equipment. By ensuring this product is disposed of correctly, you will help prevent potential negative consequences for the environment and human health, which could otherwise be caused by inappropriate waste handling of this product. The recycling of materials will help to conserve natural resources. For more detailed information about recycling of this product, please contact your local Civic Office, your household waste disposal service or the shop where you purchased the product.

Disposal of waste batteries (applicable in the European Union and other European countries with separate collection systems)



This symbol on the battery or on the packaging indicates that the battery provided with this product shall not be treated as household waste.

By ensuring these batteries are disposed of correctly, you will help prevent potentially negative consequences for the environment and human health which could otherwise be caused by inappropriate waste handling of the battery. The recycling of the materials will help to conserve natural resources.



In case of products that for safety, performance or data integrity reasons require a permanent connection with an incorporated battery, this battery should be replaced by qualified service staff only. To ensure that the battery will be treated properly, hand over the product at end-of-life to the applicable collection point for the recycling of electrical and electronic equipment.

For all other batteries, please view the section on how to remove the battery from the product safely. Hand the battery over to the applicable collection point for the recycling of waste batteries.

For more detailed information about recycling of this product or battery, please contact your local Civic Office, your household waste disposal service or the shop where you purchased the product.

Notice for customers in the United Kingdom

A moulded plug complying with BS 1363 is fitted to this equipment for your safety and convenience.

Should the fuse in the plug supplied need to be replaced, a fuse of the same rating as the supplied one and approved by ASTA or BSI to BS 1362, (i.e., marked with an  or  mark) must be used.

If the plug supplied with this equipment has a detachable fuse cover, be sure to attach the fuse cover after you change the fuse. Never use the plug without the fuse cover. If you should lose the fuse cover, please contact your nearest Sony service station.

Notice for the customers in the countries applying EU Directives

The manufacturer of this product is Sony Corporation, 1-7-1 Konan Minato-ku Tokyo, 108-0075 Japan. The Authorized Representative for EMC and product safety is Sony Deutschland GmbH, Hedelfinger Strasse 61, 70327 Stuttgart, Germany. For any service or guarantee matters please refer to the addresses given in separate service or guarantee documents.

Notes on using your camera

No compensation for contents of the recording

The contents of the recording cannot be compensated for if recording or playback is not possible due to a malfunction of your camera or a memory card, etc.

Back up recommendation

To avoid the potential risk of data loss, always copy (back up) data to other medium.

Notes on the LCD monitor and lens

- The LCD monitor is manufactured using extremely high-precision technology so over 99.99% of the pixels are operational for effective use. However, there may be some tiny black points and/or bright points (white, red, blue or green in color) that constantly appear on the LCD monitor. These points are normal in the manufacturing process and do not affect the images in any way.

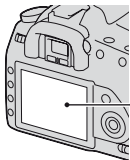

Black, white, red,
blue and green
points

- Do not expose the camera to direct sunlight. If sunlight is focused on a nearby object, it may cause a fire. When you must place the camera under direct sunlight, attach the lens cap.
- Images may trail across on the LCD monitor in a cold location. This is not a malfunction. When turning on the camera in a cold location, the LCD monitor may become temporarily dark. When the camera warms up, the monitor will function normally.
- Do not press against the LCD monitor. The monitor may be discolored and that may cause a malfunction.

Warning on copyright









Television programs, films, videotapes, and other materials may be copyrighted.

Unauthorized recording of such materials may be contrary to the provisions of the copyright laws.

The pictures used in this manual

The photographs used as examples of pictures in this manual are reproduced images, and are not actual images shot using this camera.

Table of Contents

	IMPORTANT SAFEGUARDS	3
	Read this first	5
	Notes on using your camera	8
Preparing the camera	Checking the accessories supplied	13
	Preparing the battery pack	14
	Attaching a lens	19
	Inserting a memory card	21
	Preparing the camera	25
	Using the accessories supplied	27
	Checking the number of recordable images	29
	Cleaning	31
Before your operation	Identifying parts and screen indicators	34
	Front side	34
	Rear side	35
	Sides/Bottom	36
	LCD monitor (Recording information display)	37
	Viewfinder	40
	Selecting a function/setting	41
	The functions selected by the Fn (Function) button ...	43
	The functions selected by the  /  (Drive) button	43
	Functions selected by the MENU button	43
Shooting images	Shooting an image without camera shake	45
	Correct posture	45
	Using the Super SteadyShot function	46
	Using a tripod	47
	AUTO /  Shooting with the automatic setting.....	48
	Shooting with a suitable setting for the subject (Scene Selection)	50
	 Taking portrait photos	50
	 Taking landscape photos	51
	 Taking small-subject photos	52
	 Taking moving-subject photos	53
	 Taking sunset photos	54
	 Taking night view photos	55

Shooting an image the way you want it (Exposure mode)	56
P Shooting with program auto	57
A Shooting by controlling the blur of the background (Aperture priority)	59
S Shooting a moving subject with various expressions (Shutter speed priority)	61
M Shooting with the exposure adjusted manually (Manual exposure)	63
M Shooting trails with long exposure (BULB)	65

Using the shooting function

Selecting the focus method	67
Using autofocus	67
Shooting with your desired composition (Focus-lock)	69
Selecting the focus method to suit the movement of the subject (Autofocus mode)	69
Selecting the focus area (AF area)	70
Adjusting the focus manually (Manual focus)	71
Using the flash	72
Selecting the flash mode	74
Performing wireless flash shooting	74
Adjusting the brightness of the image (Exposure, Flash compensation, Metering)	76
Shooting with fixed brightness (AE Lock)	76
Using brightness compensation for the entire image (Exposure compensation)	78
Adjusting the amount of flash light (Flash compensation)	79
Selecting the flash control mode to set the amount of flash light (Flash control)	79
Selecting the method for measuring the brightness of a subject (Metering mode)	80
Setting ISO	82

	Adjusting the color tones (White balance)	83
	Adjusting the white balance to suit a specific light source (Auto/Preset white balance)	83
	Setting the color temperature and a filter effect (Color Temperature/Color filter)	84
	Registering the color tones (Custom white balance) ..	85
	Image processing	87
	Correcting the brightness of the image (D-Range Optimizer)	87
	Selecting your desired image processing (Creative Style)	87
	☺ /  Selecting the drive mode	89
	Shooting single shot	89
	Shooting continuously	89
	Using the self-timer	90
	Shooting images with the exposure shifted (Exposure bracket)	90
	Shooting with white balance shifted (WB bracket) ...	92
Using the viewing function	Playing back images	93
	Checking the information of recorded images	98
	Protecting images (Protect)	101
	Deleting images (Delete)	102
	Viewing images on a TV screen	104
Changing your setup	Setting image size and image quality	106
	Setting the method for recording on a memory card	108
	Changing the noise reduction setting	110
	Changing the conditions under which the shutter can close	111
	Changing the functions of the button and dial	112
	Changing other settings	113
	Setting the LCD monitor	114
	Resetting to the default	116
Viewing images on a computer	Copying images to your computer	119
	Viewing images on your computer	123
	Using the software	127
Printing images	Specifying DPOF	133
	Printing images by connecting the camera to a PictBridge compliant printer	135

Others	Specifications	139
	Troubleshooting	143
	Warning messages	152
	Precautions	154
Index		156

Checking the accessories supplied

The number in parentheses indicates the number of pieces.

- BC-VM10 Battery charger (1)/
Power cord (mains lead) (1)



- Rechargeable battery pack NP-FM500H (1)



- USB cable (1)

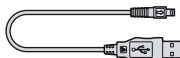

- Video cable (1)

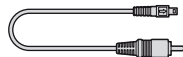

- Shoulder strap (1)

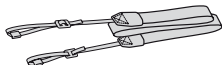

- Eyepiece cover (1)



- Body cap (1) (Attached on the camera)



- Eyecup (1) (Attached on the camera)
- CD-ROM (Application Software for α camera) (1)
- Quick Start Guide (1)
- Instruction Manual (This manual) (1)

Preparing the battery pack

When using the camera for the first time, be sure to charge the NP-FM500H “InfoLITHIUM” battery pack (supplied).

Charging the battery pack

The “InfoLITHIUM” battery pack can be charged even when it has not been fully depleted.

It can also be used when it has not been fully charged.

1 Insert the battery pack on the battery charger.

Push the battery pack until it clicks.

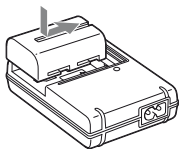

2 Connect the power cord (mains lead).

Light on: Charging

Light off: Normal charge completed

One hour after the lamp is turned off: Full charge completed

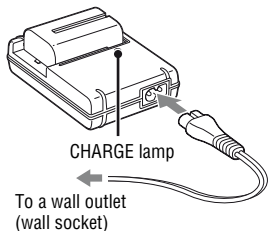

About charging time

- Time required to charge a fully depleted battery pack (supplied) at a temperature of 25°C (77°F) is as follows.

Full charge	Normal charge
Approx. 235 min.	Approx. 175 min.

- The charging time differs depending on the remaining capacity of the battery pack or charging conditions.

- We recommend charging the battery pack in an ambient temperature of between 10 to 30°C (50 to 86°F). You may not be able to efficiently charge the battery pack outside of this temperature range.

Notes

- Connect the battery charger to an easily accessible wall outlet (wall socket) close by.
- Even if the CHARGE lamp is not lit, the battery charger is not disconnected from the AC power source (mains) as long as it is connected to the wall outlet (wall socket). If some trouble occurs while using the battery charger, immediately shut off the power by disconnecting the plug from the wall outlet (wall socket).
- When charging is finished, disconnect the power cord (mains lead) from the wall outlet (wall socket), and remove the battery pack from the battery charger. If you leave the charged battery pack on the charger, battery life may be decreased.
- Do not charge any battery pack other than the “InfoLITHIUM” M series battery pack in the battery charger (supplied) with your camera. Batteries other than the specified kind may leak, overheat, or explode if you attempt to charge them, posing a risk of injury from electrocution and burns.
- When the CHARGE lamp flashes, this may indicate a battery error or that a battery pack other than the specified type have been installed. Check that the battery pack is the specified type. If the battery pack is the specified type, remove the battery pack, replace it with new one or another one and check if the battery charger operates correctly. If the battery charger operates correctly, a battery error may have occurred.
- If the battery charger is dirty, charging may not be performed successfully. Clean the battery charger with dry cloth, etc.

To use your camera abroad — Power sources

You can use your camera and the battery charger and the AC-VQ900AM AC Adaptor/charger (not supplied) in any country or region where the power supply is within 100 V to 240 V AC, 50/60 Hz. Use a commercially available AC plug adaptor [a], if necessary, depending on the design of the wall outlet (wall socket) [b].

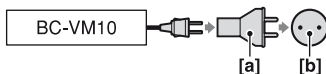

Note

- Do not use an electronic transformer (travel converter), as this may cause a malfunction.

Inserting the charged battery pack

- 1** While sliding the battery cover open lever, open the battery cover.

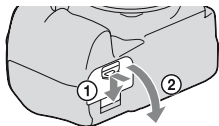

- 2** Firmly insert the battery pack all the way while pressing the lock lever with the tip of the battery.

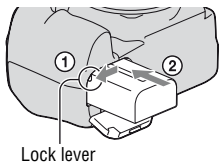

- 3** Close the battery cover.

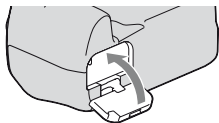

To remove the battery pack

Turn off the camera and slide the lock lever in the direction of the arrow. Be careful not to drop the battery pack.

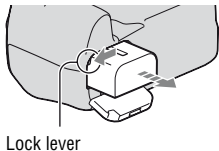

To remove the battery cover

The battery cover can be removed to attach a vertical grip (not supplied). To remove the cover, push the lever in the direction of the arrow and slide it out. To attach the cover, put the knob in the hole, pull down the lever, and slide it in.

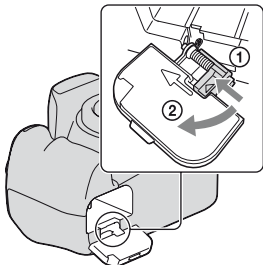

To check the remaining battery level

Set the POWER switch to ON and check the level on the LCD monitor. The level is indicated with the percent figures, in addition to the following indicators.

Battery level						“Battery exhausted”
	High Low					You cannot shoot any more pictures.

What is an “InfoLITHIUM” battery pack?

An “InfoLITHIUM” battery pack is a lithium-ion battery pack that has functions for exchanging information related to operating conditions with your camera. Using the “InfoLITHIUM” battery pack, the remaining battery time in percent figures is displayed according to the operating conditions of your camera.

Notes

- The displayed level may not be correct under certain circumstances.
- Do not expose the battery pack to water. The battery pack is not water-resistant.
- Do not leave the battery pack in extremely hot places, such as in a car or under direct sunlight.

Available battery packs

Use only an NP-FM500H battery pack. Note that the NP-FM55H, NP-FM50 and NP-FM30 cannot be used.

Effective use of the battery pack

- Battery performance decreases in low temperature surroundings. So, the time that the battery pack can be used is shorter in cold places. We recommend the following to ensure longer battery pack use: put the battery pack in a pocket close to your body to warm it up, and insert it in your camera immediately before you start shooting.
- The battery pack will run out quickly if you use the flash frequently.

Battery life

- The battery life is limited. Battery capacity decreases little by little as you use it more and more, and as time passes. If the battery operating time seems shortened considerably, a probable cause is that the battery pack has reached the end of its life. Buy a new battery pack.
- The battery life varies according to how it is stored and the operating conditions and environment in which each battery pack is used.

How to store the battery pack

If the battery pack is not to be used for a long time, fully charge it and then fully use it up once a year on your camera before storing the battery pack in a dry, cool place to prolong the battery life.

Attaching a lens

- 1 Remove the body cap from the camera and the rear cap from the lens.

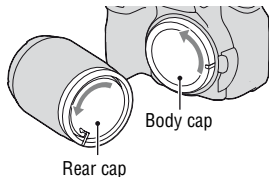

- 2 Mount the lens by aligning the orange index marks on the lens and camera.

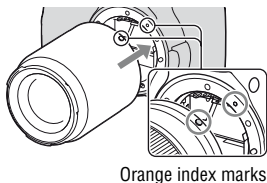

- 3 Turn the lens clockwise until it clicks into the locked position.

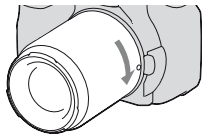

Notes

- When attaching a lens, do not press the lens release button.
- Do not use force when attaching a lens.

Lens hood

Using a lens hood is recommended to prevent unnecessary light from affecting your images. For attaching, refer to the operating instructions supplied with the lens.

To remove the lens

1 Press the lens release button all the way in and turn the lens counterclockwise until it stops.

- When changing the lens, quickly change the lens away from dusty locations so as to keep dust from getting inside the camera.

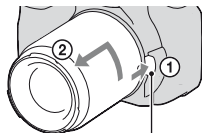

Lens release button

2 Replace the cap on the lens and attach the body cap to the camera.

- Before you attach the cap, remove dust from the cap.

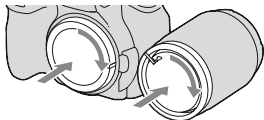

Note on changing the lens

When changing the lens, if dust or debris gets inside the camera and lands on the surface of the image sensor (the part that acts as the film), it may appear on the image, depending on the shooting environment.

The camera is equipped with an anti-dust function to prevent dust from landing on the image sensor. However, quickly change the lens away from dusty locations when attaching/removing a lens.

If dust or debris lands on the image sensor

Clean the image sensor using [Cleaning mode] in the  Setup menu (page 32).

Inserting a memory card

You can use a CompactFlash card (CF card), Microdrive, or “Memory Stick Duo” as a memory card.

1 Open the memory card cover.

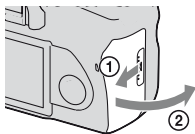

2 Insert a memory card (not supplied) from the terminal side (the terminal side has a number of small holes) with its label side facing toward the LCD monitor.

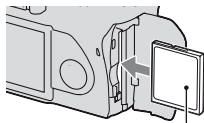

Face side with a label

- For a “Memory Stick Duo” (not supplied), insert it in a Memory Stick Duo Adaptor for CompactFlash slot (not supplied), then insert the adaptor in the camera.

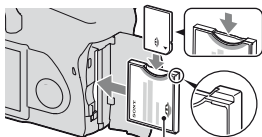

Face side with a label

3 Close the memory card cover.

To remove the memory card

Check that the access lamp is not lit, then open the memory card cover, push down the memory card eject lever. After the card is ejected a little, pull out the memory card.

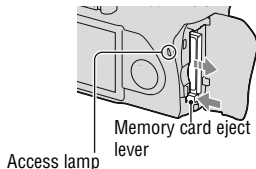

Notes on using memory cards

- The memory card may be hot just after it has been used for a long time. Be careful when you handle it.
- When the access lamp is lit, do not remove the memory card or the battery pack, or turn off the power. The data may be corrupted.
- Data may be damaged if you place the memory card near strongly-magnetized material or use the memory card in a static-prone or electrically noisy environment.
- We recommend backing up important data, such as to a hard disk of a computer.
- When you carry or store the memory card, put it in the case supplied with it.
- Do not expose the memory card to water.
- Do not touch the terminal section of the memory card with your hand or a metal object.

On the CF card/Microdrive

- Be sure to format the CF card/Microdrive using this camera when you use it for the first time.
- Do not remove the label of a CF card/Microdrive or attach a new label over the label.
- Do not press on the label strongly.

Notes on use of the Microdrive

A Microdrive is a compact and lightweight hard disk drive that complies with CompactFlash Type II.

- The Microdrive is a compact hard disk drive. Since the Microdrive is a rotating disk, the Microdrive is not strong enough to resist vibration and shock compared to a memory card.

Be sure not to transmit vibration or shock to the Microdrive during playback or shooting.

- Note that the use of the Microdrive under 5°C (41°F) may bring performance degradation.

Operating temperature range when using the Microdrive: 5 to 40°C (41 to 104°F)

- Note that the Microdrive cannot be used under low atmospheric pressure (above 3 000 meters above sea-level).
- Do not write on the label.

On the “Memory Stick”

- “Memory Stick”: You cannot use the “Memory Stick” with your camera.



- “Memory Stick Duo”: You can use the “Memory Stick Duo” with your camera by inserting it in a Memory Stick Duo Adaptor for CompactFlash slot (not supplied).

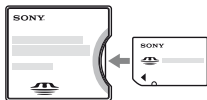

- “Memory Stick PRO Duo” or “Memory Stick PRO-HG Duo” with a capacity up to 8 GB have been confirmed to operate properly with this camera.
- A “Memory Stick Duo” formatted with a computer is not guaranteed to operate with this camera.
- Data read/write speeds differ depending on the combination of the “Memory Stick Duo” and the equipment used.

Notes on using a “Memory Stick Duo”

- Do not press down hard when you write down on the memo area.
- Do not attach a label on the “Memory Stick Duo” itself.
- Do not strike, bend or drop the “Memory Stick Duo.”
- Do not disassemble or modify the “Memory Stick Duo.”
- Do not leave the “Memory Stick Duo” within the reach of small children. They might accidentally swallow it.

- Do not use or store the “Memory Stick Duo” under the following conditions:
 - High temperature locations such as the hot interior of a car parked in direct sunlight.
 - Locations exposed to direct sunlight.
 - Humid locations or locations with corrosive substances present.

Preparing the camera

Setting up the date

When you turn the camera on for the first time, the date/time setup screen appears.

1 Set the POWER switch to ON to turn the camera on.

- To turn the camera off, set it to OFF.



2 Verify that [OK] is selected on the LCD monitor, then press the center of the controller.

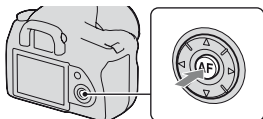

3 Select each item with ◀/▶ and set the numeric value with ▲/▼.

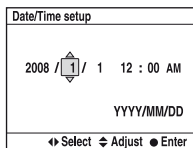
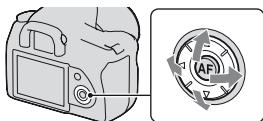

4 Repeat step 3 to set other items, then press the center of the controller.

- When changing the sequence of [YYYY/MM/DD], first select [YYYY/MM/DD] with ◀/▶, then change it with ▲/▼.

5 Verify that [OK] is selected, then press the center of the controller.

To cancel the date/time setting operation

Press the MENU button.

Adjusting the focus of the finder (diopter adjustment)

Adjust the diopter-adjustment dial to your eyesight until the indicators appear clearly in the viewfinder.

- Turn the dial toward + when you are far-sighted, toward – when you are near-sighted.
- Training the camera on the light allows you to adjust the diopter easily.

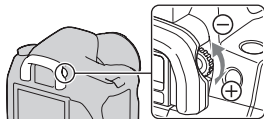

When it is hard to rotate the diopter-adjustment dial

Insert your fingers under the eyecup, and slide it upward.

- When attaching the FDA-M1AM Magnifier (not supplied) or the FDA-A1AM Angle Finder (not supplied) to the camera, remove the eyecup as illustrated and attach them.



Using the accessories supplied

This section describes how to use the shoulder strap and the eyepiece cover. The other accessories are described in the following pages.

- Rechargeable battery pack (page 14)
- Battery charger, Power cord (mains lead) (page 14)
- Eyecup (page 26)
- USB cable (pages 120, 136)
- Video cable (page 104)
- CD-ROM (page 128)

Attaching the shoulder strap

Attach the both ends of the strap on the camera.

- You can also attach the eyepiece cover (below) on the strap.

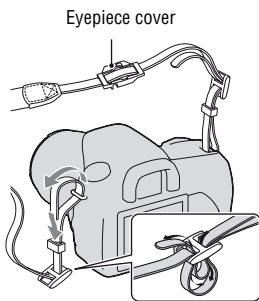

Using the eyepiece cover

You can prevent light from entering through the viewfinder and affecting the exposure. When the shutter is released without the use of the viewfinder, as in shooting with the self-timer, attach the eyepiece cover.

1 Carefully slide the eyecup off by pushing on each side of the eyecup.

- Insert your fingers under the eyecup, and slide it upward.

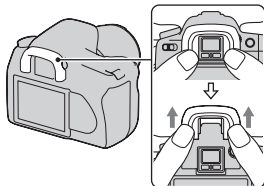

2 Slide the eyepiece cover over the viewfinder.

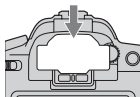

Note

- The eyepiece sensors located below the viewfinder may be activated depending on the situation, and the focus may be adjusted or the LCD monitor may continue to flash. In such cases, set [Eye-Start AF] (page 69) and [Auto off w/ VF] (page 115) to [Off].

Checking the number of recordable images

Once you insert a memory card into the camera and set the POWER switch to ON, the number of images that can be recorded (should you continue to shoot using the current settings) is displayed on the LCD monitor.

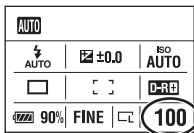

Notes

- If “0” is flashing in yellow, the memory card is full. Replace the memory card with another one, or delete images in the current memory card (pages 21, 102).
- When “----” (the number of recordable images) flashes in yellow, it means no memory card is inserted. Insert a memory card.

The number of images that can be recorded on a memory card

The table shows the approximate number of images that can be recorded on a memory card formatted with this camera. The values may vary depending on the shooting conditions.

The number of recordable images (Units: Images)

Image size: L 10M

Aspect ratio: 3:2*

Size \ Capacity	1GB	2GB	4GB	8GB
Standard	325	653	1307	2606
Fine	241	484	969	1933
RAW & JPEG	48	98	198	397
RAW	61	124	250	500

* When [Aspect ratio] is set to [16:9], you can record more images than the numbers shown in the table above. However, if it is set to [RAW], the number is the same as that of the [3:2] aspect ratio.

The number of images that can be recorded using a battery pack

The approximate number of images that can be recorded is 750 when you use the camera with the battery pack (supplied) at full capacity.

Note that the actual numbers may be less than those indicated depending on the conditions of use.

- The number is calculated with a battery pack at full capacity and in the following situation:
 - At an ambient temperature of 25°C (77°F).
 - [Quality] is set to [Fine].
 - Focus mode is set to **AF-A** (Automatic AF).
 - Shooting once every 30 seconds.
 - The flash strobes once every two times.
 - The power turns on and off once every ten times.
- The measurement method is based on the CIPA standard.
(CIPA: Camera & Imaging Products Association)
- When using a Microdrive, the number of images recordable may differ.

Cleaning

Cleaning the LCD monitor

Wipe the screen surface with an LCD cleaning kit (not supplied) to remove fingerprints, dust, etc.

Cleaning the lens

- When cleaning the lens surface, remove dust using a blower. In case of dust that sticks to the surface, wipe it off with a soft cloth or tissue paper slightly moistened with lens cleaning solution. Wipe in a spiral pattern from the center to the outside. Do not spray lens cleaning solution directly onto the lens surface.
- Do not touch the inside of the camera, such as lens contacts, or the mirror. Since dust on the mirror or around the mirror may affect the autofocus system, blow away dust using a commercially available blower. If dust lands on the image sensor, it may appear on the photo image. Turn the camera to the cleaning mode, then clean it using a blower (page 32). Do not use a spray blower to clean the inside of the camera. Using this may cause a malfunction.
- Do not use a cleaning solution containing organic solvents, such as thinner, or benzene.

Cleaning the camera surface

Clean the camera surface with a soft cloth slightly moistened with water, then wipe the surface with a dry cloth. Do not use the following as they may damage the finish or the casing.

- Chemical products such as thinner, benzene, alcohol, disposable cloths, insect repellent, sunscreen or insecticide, etc.
- Do not touch the camera with the above on your hand.
- Do not leave the camera in contact with rubber or vinyl for a long time.

Cleaning the image sensor

If dust or debris enters the camera and lands on the image sensor (the part that acts as the film), it may appear on the photo image, depending on the shooting environment. If there is dust on the image sensor, use a commercially available blower and clean the image sensor following the steps below. You can easily clean the image sensor using only the blower and the anti-dust function.

Notes

- Cleaning can be performed only when the battery level is  (three remaining battery icons) or more. Low battery power during cleaning can cause damage to the shutter. The cleaning should be completed quickly. The use of an AC Adaptor/Charger (not supplied) is recommended.
- Do not use a spray blower because it may scatter vapor inside the camera body.

1 Confirm that the battery is fully charged (page 17).

2 Press the MENU button, then select 3 with / on the controller.

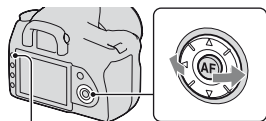

MENU button

3 Select [Cleaning mode] with / on the controller, then press the center of the controller.

The message “After cleaning, turn camera off. Continue?” appears.

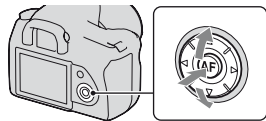

4 Select [OK] with on the controller, and press the center of the controller.

After the image sensor vibrates for a short time, the mirror in front is lifted.

5 Detach the lens (page 20).

6 Use the blower to clean the image sensor surface and the surrounding area.

- Do not touch the image sensor with the tip of the blower. Complete the cleaning quickly.
- Hold the camera's face downward to prevent the dust from resettling in the camera.
- When cleaning the image sensor, do not put the tip of a blower into the cavity beyond the lens mount.

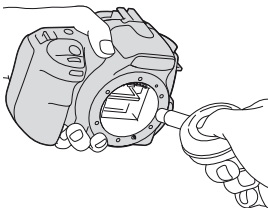

7 Attach the lens and set the POWER switch to OFF.

Note

- The camera starts beeping if the battery pack becomes low during cleaning. Stop the cleaning immediately and set the POWER switch to OFF.

Identifying parts and screen indicators

See the pages in parentheses for details of operation.



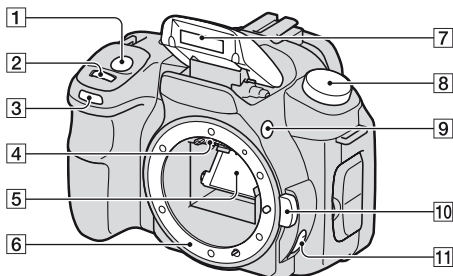





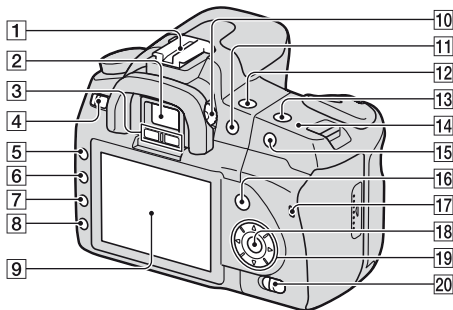



Front side



- 1 Shutter button (48)
- 2 Control dial (58, 112)
- 3 Self-timer lamp (90)
- 4 Lens contacts*
- 5 Mirror*
- 6 Lens mount
- 7 Built-in flash* (72)
- 8 Mode dial (48)
- 9  (Flash pop-up) button (72)
- 10 Lens release button (20)
- 11 Focus mode switch (67, 71)

* Do not directly touch these parts.



- | | |
|--|--|
| 1 Accessory shoe (40) | 13 ISO button (82) |
| 2 Viewfinder (26) | 14 ⊖ Image sensor position mark (68) |
| 3 Eyepiece sensors (69) | 15 For shooting: AEL (AE lock) button (64, 76)
For viewing: ⊕ (Zoom in) button (94) |
| 4 POWER switch (25) | 16 For shooting: Fn (Function) button (41)
For viewing: ⌂ (Image rotation) button (94) |
| 5 MENU button (41) | 17 Access lamp (22) |
| 6 DISP (Display) button/LCD brightness button (39, 93) | 18 Controller (Enter)/Spot AF button (70) |
| 7  (Delete) button (102) | 19 Controller (   ) |
| 8  (Playback) button (93) | 20  (Super SteadyShot) switch (46) |
| 9 LCD monitor (37, 39) | |
| 10 Diopter-adjustment dial (26) | |
| 11 For shooting:  (Exposure) button (78)
For viewing:  (Zoom out) button (94)/  (Index) button (96) | |
| 12  /  (Drive) button (89) | |

Sides/Bottom

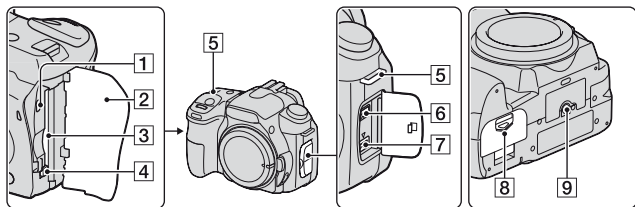

1 VIDEO OUT/USB terminal
(104, 120)

2 Memory card cover

3 Memory card insertion slot (21)

4 Memory card eject lever (22)

5 Hooks for shoulder strap (27)

6 REMOTE terminal

- When connecting the RM-S1AM/RM-L1AM Remote Commander (not supplied) to the camera, insert the plug of the Remote Commander in the REMOTE terminal, aligning the guide of the plug on the guide of the REMOTE terminal.

7 DC IN terminal

- When connecting the AC-VQ900AM AC Adaptor/Charger (not supplied) to the camera, turn the camera off, then plug the connector of the AC Adaptor/Charger to the DC IN terminal on the camera.

8 Battery cover (17)

9 Tripod receptacle

- Use a tripod with a screw length of less than 5.5 mm (7/32 inch). You will be unable to firmly secure the camera to tripods having screws longer than 5.5 mm (7/32 inch), and may damage the camera.

LCD monitor (Recording information display)

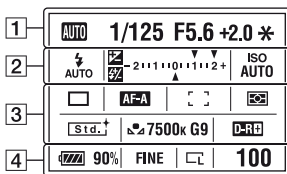

- The illustration above is for the detailed display. The enlarged display is displayed as the default setting.

1



Display	Indication
AUTO P A S M 	Mode dial (48)
1/125	Shutter speed (61)
F5.6	Aperture (59)
+2.0	Exposure (63)
*	AE lock (76)

2

Display	Indication
	Flash mode (74)/Red-eye reduction (73)
	Exposure-compensation (78)/Metered Manual (63)
	Flash compensation (79)
	EV scale (63, 91)
ISO AUTO	ISO sensitivity (82)

3

Display	Indication
	Drive mode (89)
AF-A	Focus mode (69)
AF-S	
AF-C	
	AF area (70)
	Metering (80)
	Creative Style (87)
	White balance (Auto, Preset, Color temperature, Color filter, Custom) (83)
7500K G9	
D-Range	D-Range Optimizer (87)

Display	Indication
 90%	Battery remaining (17)
RAW RAW+J FINE STD	Image quality (106)
 	Image size (106)/Aspect ratio (106)
100	Remaining number of recordable images (29)

Switching the recording information display

Press the DISP button to switch between the enlarged display and the detailed display.

When you rotate the camera to a vertical position, the display automatically rotates to adjust to the camera position.

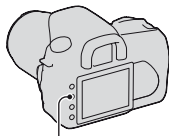

DISP button

Enlarged display

AUTO	1/125	F5.6	*
AUTO	+2.0	ISO	AUTO
90%	FINE		100

Detailed display

AUTO	1/125	F5.6	+2.0	*
AUTO	2.0	ISO	AUTO	
90%	FINE			100

No display

Note

- You can display the screen used for adjusting the brightness of the LCD monitor by pressing the DISP button a little longer (page 114).

Viewfinder

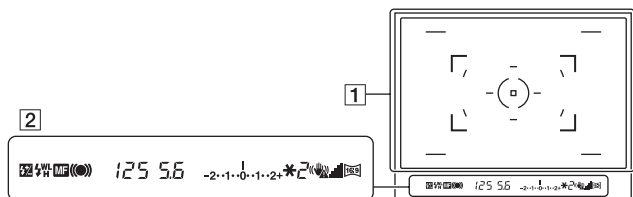

1

Display	Indication
	AF area (70)
	Spot AF area (70)
	Spot metering area (80)
	Shooting area for aspect ratio 16:9 (106)



2

Display	Indication
	Flash compensation (79)
	Flash charging (74)
WL	Wireless flash (74)
H	High-speed sync*
MF	Manual focus (71)
	Focus
125	Shutter speed (61)
5.6	Aperture (59)
	EV scale (63, 91)
*	AE lock (76)
2	Shots-remaining counter (89)
	Camera shake warning (46)







Display	Indication
	Super SteadyShot scale (46)
	Aspect ratio 16:9 (106)

* When using the HVL-F56AM/HVL-F36AM Flash (not supplied), you can shoot with a High-speed sync feature at any shutter speed. For details, refer to the operating instructions supplied with the flash.







Selecting a function/setting

You can select a function for shooting or playback from the menu list. To display the menu list, press the Fn (Function) button,  /  (Drive) button, or MENU button.

Example: When the Fn button is pressed.

Flash mode 	Metering mode 
Autofocus mode 	AF area 
White balance 	D-Range Optimizer 
 Select ● Enter	

From the menu list, use the controller to move the cursor to the setting of your choice and execute the selection.

 : Press  /  /  /  on the controller to move the cursor.

: Press the center button to execute the selection.

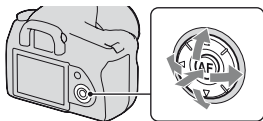

In this instruction manual, the process of selecting a function with the controller from the menu list is described as follows:

Example: Fn button → [White balance] → Select the desired setting

When you start the operation, an operation guide of controller functions will be displayed at the bottom of the screen. Please refer to the guide when operating the camera. The step-by-step description of the above example is as follows:

1 Press the Fn button.

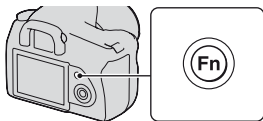

- 2** Following the operation guide, select [White balance] with ▲/▼/◀/▶ on the controller, then press the center ● to execute.

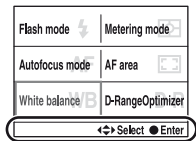

Operation guide

- 3** Following the operation guide, select and execute the desired function.

For example, to change [5500K] (the current setting), select [5500K] with ▲/▼, adjust the value of [ColorTemperature] with ◀/▶, then press the center ● to execute.

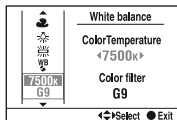

The operation guide list



The operation guide also indicates operations other than the controller operation. The indications of icons are as follows.

	MENU button
	Returns with MENU button
	Trash can button
	Zoom in button
	Zoom out button
	Play button

The functions selected by the Fn (Function) button

- Flash mode (page 74)
- Autofocus mode (page 69)
- White balance (page 83)
- Metering mode (page 80)
- AF area (page 70)
- D-RangeOptimizer (page 87)

The functions selected by the (Drive) button

-  Single-shot adv. (page 89)
-  Continuous adv. (page 89)
-  Self-timer (page 90)
- BRK C** Bracket: Cont. (page 90)
- BRK S** Bracket: Single (page 90)
- BRK WB** WB bracket (page 92)

Functions selected by the MENU button

Recording menu

 1	Image size (106) Aspect ratio (106) Quality (106) Creative Style (87) Flash control (79) Flash compens. (79)
---	---

 2	Priority setup (111) AF illuminator (73) Long exp.NR (110) High ISO NR (110) Rec mode reset (116)
---	---

Custom menu



 1	Eye-Start AF (69) AEL button (112) Ctrl dial setup (112) Red eye reduc. (73) Auto review (114) Auto off w/ VF (115)
---	--

Playback menu

 1	Delete (102) Format (109) Protect (101) DPOF setup (133) <ul style="list-style-type: none">• Date imprint (134)• Index print (134)
--	--

 2	PlaybackDisplay (93) Slide show (97) <ul style="list-style-type: none">• Interval (97)
---	---

Setup menu

 1	LCD brightness (114) Info.disp.time (114) Power save (113) Video output (105)  Language (113) Date/Time setup (113)
--	---

 2	File number (108) Folder name (108) Select folder (109) <ul style="list-style-type: none">• New folder (109) USB connection (120, 135) Audio signals (113)
---	---

 3	Cleaning mode (32) Reset default (117)
--	---

Shooting an image without camera shake

“Camera shake” refers to an unwanted movement of the camera that occurs after the shutter button has been pressed, resulting in a blurred image. To reduce camera shake, follow the instructions below.

Correct posture

Stabilize your upper body and take a position that keeps the camera from moving.

Point ①

One hand holds the grip of the camera, and the other hand supports the lens.

Point ②

Lightly tuck your elbows against your body.

When shooting in a kneeling position, steady your upper body by placing your elbow on your knee.

Point ③

Take a secure stance with your feet shoulder-width apart.

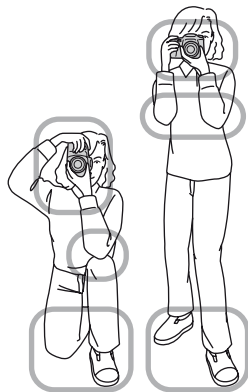

Camera shake warning indicator

Due to potential camera shake, the  (Camera shake warning) indicator flashes in the viewfinder. In this case, use the Super SteadyShot function, a tripod, or the flash.

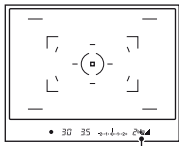

 (Camera shake warning) indicator

Note

- The  (Camera shake warning) indicator is displayed only in the modes that the shutter speed is automatically set. This indicator is not displayed in M/S/P_S modes.

Using the Super SteadyShot function

This Super SteadyShot function can reduce the effect of camera shake by the equivalent of approximately 2.5 to 3.5 increments of shutter speed.

Set the switch to “ON.”

- The  (Super SteadyShot scale) indicator appears. Wait until the scale becomes low, then start shooting.

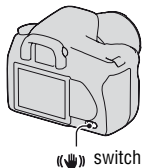

 switch

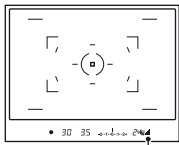

 (Super SteadyShot scale) indicator

Note

- The Super SteadyShot function may not work optimally when the power has just been turned on, when the subject has just entered the area, or when the shutter button has been pressed all the way down without stopping halfway. Wait for the  (Super SteadyShot scale) indicator scale to go down, and then press the shutter button down slowly.

Using a tripod

In the following cases, we recommend that you mount the camera on a tripod.

- Shooting without a flash under dark conditions.
- Shooting with slow shutter speeds, which are typically used in night-time shooting.
- Shooting a close subject, such as in macro shooting.
- Shooting with a telescopic lens.
- Shooting a moving subject.

Note

- When using a tripod, deactivate the Super SteadyShot function.

AUTO/ Shooting with the automatic setting

The “AUTO” mode allows you to easily shoot any subject under any conditions.

Select  when shooting in a location where the use of a flash is restricted.

- 1 Set the mode dial to **AUTO** or  (Flash Off).**

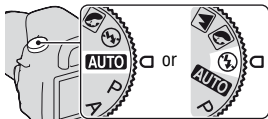

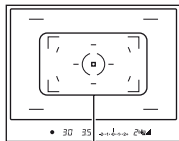

- 2 Hold the camera and look into the viewfinder.**

The subject inside the focus area comes into focus (Eye-Start AF, page 69).



Focus area

- 3 Place the desired subject within the focus area.**

- If the  (Camera shake warning) indicator flashes, set the  switch to ON to activate the Super SteadyShot function, or use a tripod.

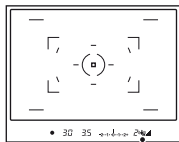

 (Camera shake warning) indicator

- 4 When using a zoom lens, turn the zoom ring, then decide on your shot.**



5 Press the shutter button halfway down to focus.

When the focus is confirmed, the focus indicator ● or (●) (Focus indicator) lights up (page 68).

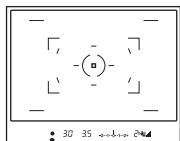
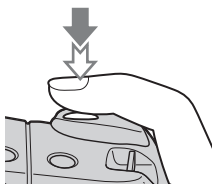

Focus indicator

6 Press the shutter button fully down to shoot.

- When the (👉) switch is set to ON, wait until the scale of the 📶 (Super SteadyShot scale) indicator becomes low, then start shooting.

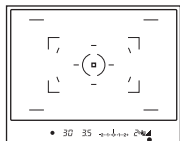
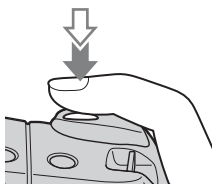

📶 (Super SteadyShot scale) indicator

Note

- If you turn the camera off or change the recording mode in AUTO or Scene Selection mode, the settings you set up with the Fn button, (🔄) / (📷) button, ISO button, or MENU button are reset to the default settings. The manual focus feature is also released.

Shooting with a suitable setting for the subject (Scene Selection)

Selecting an appropriate mode for the subject or the shooting conditions allows you to shoot the image with a more suitable setting for the subject than in “AUTO” mode.



Taking portrait photos

This mode is suitable to

- Blur away backgrounds and sharpen the subject.
- Reproduce skin tones softly.



Set the mode dial to  (Portrait).

Shooting techniques

- To blur the background more, set the lens to the telephoto position.
- You can shoot a vivid image by focusing on the eye that is closer to the lens.
- Use the lens hood to shoot backlit subjects.
- Use the red-eye reduction function if the eyes of your subject turn red from the flash (page 73).



Taking landscape photos

This mode is suitable to

- Shoot the entire range of scenery in sharp focus with vivid colors.



Set the mode dial to  (Landscape).

Shooting technique

- To accentuate the openness of the scenery, set the lens to wide angle.

Taking small-subject photos

This mode is suitable to

- Shoot close subjects such as flowers, insects, dishes, or small goods. You can achieve clear and sharp focus.



Set the mode dial to  (Macro).

Shooting techniques

- Get close to the subject and shoot at the minimum distance of the lens.
- You can shoot a closer subject using a macro lens.
- Set the built-in flash to  (Flash Off) when you shoot a subject within 1 m (3.3 feet).
- In macro mode shooting, the Super SteadyShot function will not be fully effective. Use a tripod to achieve better results (page 47).



Taking moving-subject photos

This mode is suitable to

- Shoot moving subjects outdoors or in bright places.



Set the mode dial to  (Sports action).

Shooting techniques

- The camera shoots images continuously while the shutter button is pressed.
- Press and hold the shutter button halfway down until the right moment.
- Set the ISO sensitivity higher when shooting in poor light (page 82).



Taking sunset photos

This mode is suitable to

- Shoot the red of the sunset beautifully.



Set the mode dial to  (Sunset).

Shooting techniques

- Used to shoot an image accentuating the red color compared with other modes. This is also suitable for shooting the beautiful red of the sunrise.
- You can adjust the depth of the color by exposure compensation. Shifting to the under side (-) deepens the colors, while shifting to the over side (+) attenuates the colors.



Taking night view photos

This mode is suitable to

- Shoot portraits in night scenes.



- Shoot night scenes at a distance without losing the dark atmosphere of the surroundings.



Set the mode dial to (Night portrait/Night view).

Set [Flash mode] to  (Flash Off) when you shoot a night view without persons (page 74).

Shooting techniques

- Take care that the subject does not move to prevent the image from blurring.
- The shutter speed is slower, so using a tripod is recommended.

Note

- The picture may not be taken properly when shooting a wholly dark night scene.

Shooting an image the way you want it (Exposure mode)

With a single lens reflex camera, you can adjust the shutter speed (how long the shutter is open) and aperture (the range that is in focus: depth of field) to enjoy a variety of photographic expressions.

For example, you can use a fast shutter speed to shoot the ephemeral shape of a wave, or you can accentuate a flower by opening the aperture to put everything in front of and beyond the flower out of focus. These are a few of the effects you can enjoy with your camera (pages 59, 61).

Adjusting the shutter speed and aperture not only creates the photographic effects of movement and focus, but also determines the brightness of the image by controlling the amount of exposure (the amount of light the camera takes in), which is the most important factor in photo shooting.

Changing of picture brightness by the amount of exposure



Amount of exposure

low

high

When using a faster shutter speed, the camera opens the shutter for a shorter time. This means less time for the camera to take in light, resulting in a darker picture. To take a brighter picture, you can open the aperture (the hole through which the light passes) to some extent in order to adjust the amount of light the camera takes in at one time.

The brightness of the picture adjusted by the shutter speed and aperture is called “exposure.”

This section will show you how to adjust the exposure and enjoy various photo expressions by the use of movement, focus, and light. You can find out the right way to shoot the image and the subject you like.

P Shooting with program auto

This mode is suitable to

- Use the automatic exposure, while keeping the custom settings for ISO sensitivity, Creative Style, D-Range optimizer, etc.
- Keep the exposure compensation measured by the camera, but change the combination of shutter speed and aperture depending on the subject (Program shift).



1 Set the mode dial to P.

2 Set the shooting functions to your desired settings (pages 67 to 92).

The settings will be stored until you reset the settings.

- To fire the flash, press the  button.

3 Adjust the focus and shoot the subject.

To use Program shift

1 Press the shutter button halfway down to adjust the focus.

The correct exposure (shutter speed and aperture value) determined by the camera is indicated.

Shutter speed

Aperture value

P	1/500	F8
Ⓢ	±0.0	ISO AUTO
□	[]	D-R
90%	FINE	100

2 Rotate the control dial to select your desired combination while the focus is achieved.

The recording mode indicator is switched to “P_S” (Shutter speed priority program shift), and the shutter speed and aperture value are changed.

- Switch to “P_A” (Aperture priority program shift) when you want to select a combination by reference to the aperture value (page 112).

P_S

Shutter speed

Aperture value

Ps	1/125	F16
Ⓢ	±0.0	ISO AUTO
□	[]	D-R
90%	FINE	100

3 Shoot the subject.

Notes

- If you turn the camera off and on or a certain period of time is passed, Program shift “P_S” or “P_A” is canceled and returned to “P.”
- When Program Shift “P_S” is selected, the  (Camera shake warning) indicator is not displayed.

A Shooting by controlling the blur of the background (Aperture priority)

This mode is suitable to

- Put the subject in sharp focus and blur everything in front of and beyond the subject. Opening the aperture narrows the range that is in focus. (Depth of field becomes shallower.)
- Shoot the depth of the scenery. Narrowing down the aperture widens the range that is in focus. (Depth of field becomes deeper.)



1 Set the mode dial to A.

2 Select the aperture value (F-number) with the control dial.

- Smaller F-number: The foreground and background of the subject are blurred.
Larger F-number: The subject and its foreground and background are also focused on.
- You cannot check the blurring of an image in the viewfinder. Check the recorded image and adjust the aperture.

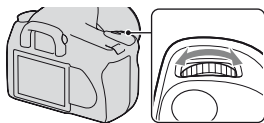

Aperture (F-number)

A	(F5.6)	
Ⓢ	±0.0	ISO AUTO
□	[]	D-R
90%	FINE	100

3 Adjust the focus and shoot the subject.

The shutter speed is automatically adjusted to obtain correct exposure.

- When the camera judges that the proper exposure is not obtained with the selected aperture value, the shutter speed flashes. In such cases, adjust the aperture again.

Shutter speed

A	(1/500)	F5.6
Ⓢ	±0.0	ISO AUTO
□	[]	D-R
90%	FINE	100

Shooting techniques

- The shutter speed may become slower depending on the aperture value. When the shutter speed is slower, use a tripod.
- The flash range differs according to the aperture value. When you shoot with the flash, check the flash range (page 73).
- To blur the background more, use a telephoto lens or a lens that is equipped with a smaller diaphragm (bright lens).

S Shooting a moving subject with various expressions (Shutter speed priority)

This mode is suitable to

- Shoot a moving subject at a moment in time. Use a faster shutter speed to crisply shoot an instant of the movement.
- Trace the movement to express the dynamism and flow. Use a slower shutter speed to shoot a trailing image of the moving subject.



1 Set the mode dial to S.

2 Select the shutter speed with the control dial.

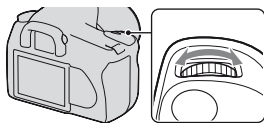

Shutter speed

S	1/500	
Ⓢ	±0.0	ISO AUTO
□	□ □	D-R
90%	FINE	100

3 Adjust the focus and shoot the subject.

The aperture is automatically adjusted to obtain correct exposure.

- When the camera judges that the proper exposure is not obtained with the selected shutter speed, the aperture value flashes. In such cases, adjust the shutter speed again.

Aperture (F-number)

S	1/500	F4.5
Ⓢ	±0.0	ISO AUTO
□	□ □	D-R
90%	FINE	100

Shooting techniques

- When the shutter speed is slower, use a tripod.
- When shooting an indoor sport, select a higher ISO sensitivity.

Notes

- The  (Camera shake warning) indicator is not indicated in shutter speed priority mode.
- When using the flash, if you close the aperture (a larger F-number) by making the shutter speed slower, the light of the flash does not reach a distant subject.
- The higher the ISO sensitivity, the more outstanding the noise.
- When the shutter speed is one second or more, noise reduction (Long exp.NR) will be done after shooting (page 110). You cannot do any further shooting during the reduction.

M Shooting with the exposure adjusted manually (Manual exposure)

This mode is suitable to

- Shoot with the desired exposure setting by adjusting both the shutter speed and aperture.
- Use an exposure meter.



1 Set the mode dial to M.







2 Rotate the control dial to adjust the shutter speed, and while pressing the button, rotate the control dial to adjust the aperture.

- You can assign a function to the control dial with [Ctrl dial setup] (page 112).



 button

Shutter speed
Aperture (F-number)

M	1/500	F5.6
	 ±0,0	ISO 100
		D-R
 90%	FINE 	100

3 Shoot the image after the exposure is set.

- Check the exposure value on the EV scale.
Toward +: Images become brighter.
Toward -: Images become darker.
The ◀ ▶ arrow appears if the set exposure is beyond the range of the EV scale. The arrow starts flashing if the difference becomes greater.

 : Metered Manual

LCD monitor (Detailed display)



Standard value

Viewfinder

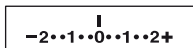

Standard value

Notes

- The  (Camera shake warning) indicator is not indicated in manual exposure mode.
- When the mode dial is set to M, the ISO setting [AUTO] is set to [100]. In M mode, the ISO setting [AUTO] is not available. Set the ISO sensitivity as necessary.

Manual shift

You can change the shutter speed and aperture value combination without changing the exposure you set.

Rotate the control dial while pressing the AEL button to select the shutter speed and aperture value combination.

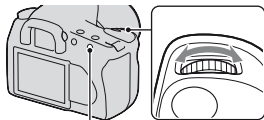

AEL button

M Shooting trails with long exposure (BULB)

This mode is suitable to

- Shoot trails of light, such as fireworks.
- Shoot trails of stars.



1 Set the mode dial to M.

2 Rotate the control dial to the left until [BULB] is indicated.

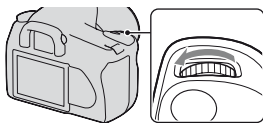

BULB

M	BULB	F5.6
		ISO 100
		D-R
90%	FINE	100

3 While pressing the button, rotate the control dial to adjust the aperture (F-number).

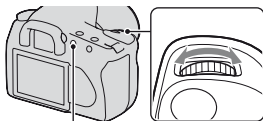

button

4 Press the shutter button halfway down to adjust the focus.

5 Press and hold the shutter button for the duration of the shooting.

As long as the shutter button is pressed, the shutter remains open.

Shooting techniques

- Use a tripod.
- Set the focus to infinity in manual focus mode when shooting fireworks, etc.
- If you use a Remote Commander that is equipped with a shutter button lock function (not supplied), you can leave the shutter open using the Remote Commander.

Notes

- When using a tripod, turn off the Super SteadyShot function.
- The longer the exposure time, the more outstanding the noise on the image.
- After shooting, noise reduction (Long exp.NR) will be done for the same amount of time that the shutter was open. You cannot do any further shooting during the reduction.

Selecting the focus method

There are two methods for adjusting the focus: autofocus and manual focus.

Using autofocus

1 Set the focus mode switch to AF.

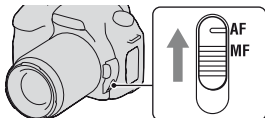

2 Look into the viewfinder.

The subject inside the focus area comes into focus automatically (Eye-Start AF).

3 Press the shutter button halfway down to check the focus and shoot the image.

- When the focus is confirmed, the focus indicator changes to ● or (●) (page 68).
- The sensor used for focusing in the AF area illuminated briefly in red (page 70).

Focus area sensor

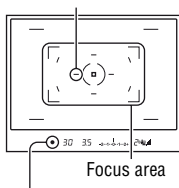

Focus indicator

Shooting technique

- To select the area used for focusing, set up [AF area] (page 70).

Focus indicator

Focus indicator	Status
● lit	Focus locked. Ready to shoot.
⊙ lit	Focus is confirmed. Focal point moves following a moving subject. Ready to shoot.
⊕ lit	Still focusing. You cannot release the shutter.
● flashing	Cannot focus. The shutter is locked.

Subjects that may require special focusing:

Using the autofocus, it is hard to focus on the following subjects. In such cases, use the focus lock shooting feature (page 69) or manual focus (page 71).

- A subject that is low in contrast, such as blue sky or a white wall.
- Two subjects at different distances overlapping in the AF area.
- A subject that is composed of repeating patterns, such as the facade of a building.
- A subject that is very bright or glittering, such as the sun, the body of an automobile, or the surface of water.

To measure the exact distance to the subject

The ⊖ mark located on the top of the camera shows the location of the image sensor*. When you measure the exact distance between the camera and the subject, refer to the position of the horizontal line.

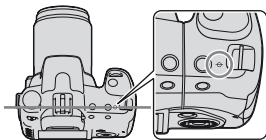

* The image sensor is the part of the camera that acts as the film.

Note

- If the subject is closer than the minimum shooting distance of the attached lens, the focus cannot be confirmed. Make sure you put enough distance between the subject and the camera.

To deactivate the Eye-Start AF function

MENU button → **⚙ 1** → **[Eye-Start AF]** → **[Off]**

- When attaching the FDA-M1AM Magnifier (not supplied) or the FDA-A1AM Angle Finder (not supplied) to the camera, setting [Eye-Start AF] to [Off] is recommended because the eyepiece sensors located below the viewfinder may be activated.

Shooting with your desired composition (Focus-lock)

1 Place the subject within the AF area and press the shutter button halfway down.



2 Keep the shutter button halfway down, and put the subject back in the original position to re-compose the shot.



3 Press the shutter button fully down to take the picture.

Selecting the focus method to suit the movement of the subject (Autofocus mode)

Fn button → **[Autofocus mode]** → **Select the desired setting**

AF-S (Single-shot AF)

The camera focuses on and the focus is locked when you press the shutter button halfway down.

AF-A (Automatic AF)	When you press and hold the shutter button, if the subject is motionless, the focus is locked and if the subject is in motion, the camera continues to focus.
AF-C (Continuous AF)	The camera continues to focus while the shutter button is pressed and held halfway down. <ul style="list-style-type: none"> • The audio signals will not sound when the subject is in focus.

Shooting techniques

- Use **AF-S** (Single-shot AF) when the subject is motionless.
- Use **AF-C** (Continuous AF) when the subject is in motion.

Selecting the focus area (AF area)

Select the desired AF area to suit the shooting conditions or your preference. The area used for focusing is illuminated briefly.

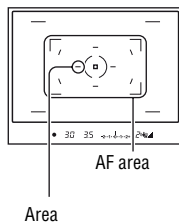

Fn button → [AF area] → Select the desired setting

(Wide)	The camera determines which of the nine AF areas is used in focusing within the AF area. If you press and hold the center of the controller, you can adjust the focus using the spot AF area.
(Spot)	The camera uses the spot AF area exclusively.
(Local)	Choose the area for which you want to activate the focus from among nine areas with the controller during the shooting. To select the spot AF area, press the center of the controller.

Note

- The AF area may not be illuminated during continuous shooting or when the shutter button is pressed all the way down without pause.

Adjusting the focus manually (Manual focus)

When it is difficult to get the proper focus in autofocus mode, you can adjust the focus manually.

1 Set the focus mode switch to MF.

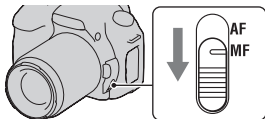

2 Rotate the focusing ring of the lens to achieve a sharp focus.

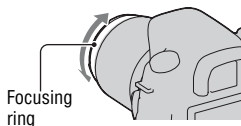

Notes

- In the case of a subject that can be focused in autofocus mode, the ● indicator lights up in the viewfinder when the focus is confirmed. When the Wide AF area is used, the center area is used, and when the Local AF area is used, the area that is selected with the controller is used.
- The camera resets the focal length to ∞ (infinity) when the POWER switch is set to ON.
- When using a tele converter, etc., rotation of the focusing ring may not be smooth.
- The correct focus is not achieved if the diopter is not adjusted properly (page 26).
- When you turn the camera off and then on again, or change the recording mode with the mode dial set to “AUTO” or Scene Selection, AF (Autofocus) is automatically selected regardless of the position of the focus mode switch.

Using the flash

In a dark location, using the flash allows you to shoot the subject brightly, and it also helps to prevent camera shake. When shooting into the sun, you can use the flash to shoot a bright image of the backlit subject.

1 Press the ⚡ button.

The flash pops up.

- In AUTO or Scene Selection mode, the flash automatically pops up if the amount of light is insufficient or the subject is backlit. The built-in flash does not pop up even if you press the ⚡ button.

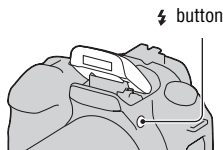

2 After the flash charging is completed, shoot the subject.

⚡ Flashing: The flash is being charged. When the indicator flashes, you cannot release the shutter.

⚡ Lit: The flash has been charged and is ready to fire.

- When you press the shutter button halfway down under dark lighting in autofocus mode, the flash may be fired to help easily focus a subject (AF illuminator).

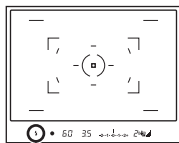

⚡ (Flash charging) indicator

Shooting techniques

- The lens or lens hood may block the light of the flash and a shadow may appear on the image. Remove the lens hood.
- Shoot the subject at a distance of 1 m (3.3 feet) or greater.

Notes

- Do not hold the camera by grabbing the flash emitter.
- Do not use the camera while the flash is not fully pulled up.



- Shooting conditions required to prevent shade from appearing on an image vary, depending on the lens.

The flash range

The range within which the correct exposure is provided depends on the combination of the flash range and ISO sensitivity. Refer to the following table to determine the shooting distance.

Aperture		F2.8	F4.0	F5.6
ISO setting	AUTO	1.4 – 8.6 m (4.6 – 28 feet)	1 – 6 m (3.3 – 20 feet)	1 – 4.3 m (3.3 – 14 feet)
	100	1 – 4.3 m (3.3 – 14 feet)	1 – 3 m (3.3 – 9.8 feet)	1 – 2.1 m (3.3 – 6.9 feet)
	200	1 – 6 m (3.3 – 20 feet)	1 – 4.3 m (3.3 – 14 feet)	1 – 3 m (3.3 – 9.8 feet)
	400	1.4 – 8.6 m (4.6 – 28 feet)	1 – 6 m (3.3 – 20 feet)	1 – 4.3 m (3.3 – 14 feet)
	800	2 – 12 m (6.6 – 39 feet)	1.4 – 8.6 m (4.6 – 28 feet)	1 – 6 m (3.3 – 20 feet)
	1600	2.8 – 17 m (9.2 – 56 feet)	2 – 12 m (6.6 – 39 feet)	1.4 – 8.6 m (4.6 – 28 feet)
	3200	4 – 24 m (13 – 79 feet)	2.8 – 17 m (9.2 – 56 feet)	2 – 12 m (6.6 – 39 feet)

The AF illuminator

- AF illuminator does not operate when [Autofocus mode] is set to **AF-C** (Continuous AF) or the subject is moving in **AF-A** (Automatic AF). (The  or  indicator lights in the viewfinder.)
- The AF illuminator may not operate with focal lengths of 300 mm or longer.
- When an external flash is attached, the AF illuminator of the external flash is used.

To deactivate the AF illuminator

MENU button →  **2** → [AF illuminator] → [Off]

To use the red-eye reduction

The red-eye reduction reduces the red-eye phenomenon by providing pre-flash (low-flash light) a few times before shooting when using the flash.







MENU button →  **1** → [Red eye reduc.] → [On]

Note

- The red-eye reduction is available only when the built-in flash is used.

Selecting the flash mode

Fn button → **[Flash mode]** → **Select the desired setting**

 (Flash Off)	Does not fire even if the built-in flash pops up. This is not selectable when the mode dial is set to P, A, S, or M.
 (Autoflash)	Fires if it is dark or against light. This is not selectable when the mode dial is set to P, A, S, or M.
 (Fill-flash)	Fires whenever the built-in flash pops up.
 (Slow sync.)	Fires whenever the built-in flash pops up. Slow sync shooting allows you to shoot a clear image of both the subject and the background by slowing the shutter speed.
 (Rear sync.)	Fires right before the exposure is completed whenever the built-in flash pops up.
 (Wireless)	Fires an external flash (not supplied) that is off the camera and away from it (Wireless flash shooting).

Shooting techniques

- When shooting indoors or using nightscape, you can use slow sync to shoot a bright image of people and the background.
- You can use rear sync to shoot a natural image of the trailing of a moving subject such as a moving bicycle or a walking person.

Performing wireless flash shooting

With an external wireless flash (not supplied), you can shoot with the flash without a cord when the external flash is not attached to the camera. By changing the position of the flash, you can shoot an image with a three dimensional feel by highlighting the contrast of light and shadow on the subject.

For the actual steps of shooting, refer to the operating instructions of the flash.

Fn button → **[Flash mode]** → $\frac{1}{\text{wt}}$ **(Wireless)**

- To do a pre-flash test, pull up the flash and press the AEL button on the camera.

Notes

- Turn off the wireless flash mode after wireless flash shooting. If the built-in flash is used while the wireless flash mode is still active, inaccurate flash exposures will result.
- Change the channel of the external flash when another photographer is using a wireless flash nearby and his/her built-in flash light triggers firing of your flash. To change the channel of the external flash, refer to the operating instructions supplied with it.

The AEL button setting

When using the wireless flash, it is recommended that you set [AEL button] (page 112) to [AEL hold] in the  Custom menu.

Adjusting the brightness of the image (Exposure, Flash compensation, Metering)

Shooting with fixed brightness (AE Lock)

When shooting into the sun or by a window, the exposure may not be appropriate for the subject because of the big difference in lighting between the subject and the background. In such cases, use the light meter where the subject is bright enough and lock the exposure before shooting. To reduce the brightness of the subject, point the camera forwards a spot that is brighter than the subject and use the light meter to lock the exposure of the entire image. To make the subject brighter, point the camera forwards a spot that is darker than the subject and use the light meter to lock the exposure of the entire image.

This section describes how to shoot a brighter image of the subject using the  (Spot).

The spot where you lock the exposure.



1 Fn button → [Metering mode] →  (Spot)

2 Adjust the focus on the portion you want to lock the exposure.

The exposure is set when the focus is achieved.

3 Press the AEL button to lock the exposure.

* (AE lock mark) appears in the viewfinder and on the LCD monitor.

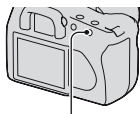

AEL button

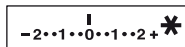

4 While pressing the AEL button, focus on the subject, and shoot the subject.

- If you continue to shoot with the same exposure value, press and hold the AEL button after the shooting. The setting is canceled when the button is released.

To check the exposure of the image

Hold down the AEL button and place the spot metering circle on the spot where the lighting is contrasted from the subject.

The metering indicator displays the degree of exposure difference, zero being the locked exposure.

Shifting to the + side makes the image brighter, and shifting to the – side makes the image darker.

When the image is too bright or too dark to get the proper exposure, ◀ or ▶ appears or flashes at the end of the indicator.

Spot metering circle

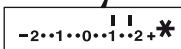
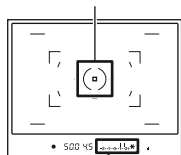

Using brightness compensation for the entire image (Exposure compensation)

Except for recording mode M, the exposure is automatically acquired.
(Automatic exposure)

Based on the exposure acquired by the automatic exposure, you can perform exposure compensation by shifting the exposure to either the + side or the - side, depending on your preference. You can make the entire image brighter by shifting to the + side. The entire image becomes darker when you shift it to the - side.

Adjust in the -
direction



Base exposure



Adjust in the +
direction



1 Press the  button to display the exposure compensation screen.

 button



2 Adjust the exposure with the control dial.

Toward + (over): Brightens an image.

Toward - (under): Darkens an image.

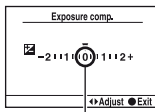

Standard exposure

3 Adjust the focus and shoot the subject.

Shooting techniques

- Adjust the compensation level by checking the recorded image.
- Using bracket shooting, you can shoot multiple images with the exposure shifted to the plus or minus sides (page 90).

Adjusting the amount of flash light (Flash compensation)

When shooting with the flash, you can adjust the amount of flash light alone, without changing the exposure compensation. You can only change the exposure of a main subject which is within the flash range.

MENU button →  **1** → **[Flash compens.]** → **Select the desired setting**

- Toward +: Makes the flash level higher.
Toward -: Makes the flash level lower.

Notes

- If you have adjusted the flash level,  appears in the viewfinder when the built-in flash is pulled up. When you adjust it, be careful not to forget to reset the value.
- The positive effect may not be visible due to the limited amount of flash light, if the subject is at or around the maximum range for the flash. If the subject is very close, the negative effect may not be visible.

Exposure compensation and flash compensation

Exposure compensation changes the shutter speed, aperture, and ISO sensitivity (when [AUTO] is selected) to perform the compensation. If the flash is used, the amount of flash light is also changed.

However, flash compensation only changes the amount of flash light.

Selecting the flash control mode to set the amount of flash light (Flash control)

MENU button →  **1** → **[Flash control]** → **Select the desired setting**

ADI flash	This method controls the lighting of the flash, factoring in the focus distance information and light metering data from the pre-flash. This method enables an accurate flash compensation with virtually no effect from the reflection off the subject.
Pre-flash TTL	This method controls the amount of flash light depending on the data only from pre-flash light metering. This method is susceptible to the reflection off the subject.

ADI: Advanced Distance Integration

TTL: Through the lens



- When [ADI flash] is selected, using a lens that is provided with a distance encoder feature can perform more accurate flash compensation by using more accurate distance information.

Notes

- When the distance between the subject and the external flash (not supplied) cannot be determined (wireless flash shooting using an external flash (not supplied), shooting with an off-camera flash using a cable, shooting with a macro twin flash, etc.), the camera automatically selects Pre-flash TTL mode.
- Select [Pre-flash TTL] in the following cases, as the camera cannot perform flash compensations with ADI flash.
 - A wide panel is attached to the HVL-F36AM flash.
 - A diffuser is used for flash shooting.
 - A filter with an exposure factor, such as an ND filter, is used.
 - A close-up lens is used.
- ADI flash is only available in combination with a lens that is provided with a distance encoder. To determine if the lens is equipped with a distance encoder, refer to the operating instructions supplied with the lens.

Selecting the method for measuring the brightness of a subject (Metering mode)

Fn button → [Metering mode] → Select the desired mode

 (Multi segment)	This divides the whole screen into 40 segments to measure light (40-segment honeycomb pattern metering).
 (Center weighted)	While emphasizing the central area of the screen, this mode measures the average brightness of the entire screen.
 (Spot)	This mode measures light only in the spot metering circle in the center of the frame.

Shooting techniques

- Use  (Multi segment) metering for general shooting.
- When shooting a subject with strong contrast in the focus area, measure the light of the subject you want to shoot with the proper exposure using Spot metering, then perform AE lock shooting (page 76).

Setting ISO

Sensitivity to light is expressed by the ISO number (recommended exposure index). The larger the number, the higher the sensitivity.

1 Press the ISO button to display the ISO screen.

ISO button

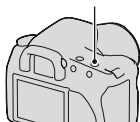

2 Select the desired value with ▲/▼ on the controller.

- The larger the number, the higher the noise level.

Notes





- When ISO is set to [AUTO], ISO is automatically set as follows.

Recording mode	ISO
AUTO, Scene Selection	The range differs depending on the mode
P, A, S	100 – 400

- The [AUTO] setting is not provided in recording mode M. If you change the recording mode to M with the [AUTO] setting, it is switched to [100]. Set the ISO according to your shooting conditions.

Adjusting the color tones (White balance)

The color tone of the subject changes depending on the characteristics of the light source. The table below shows how the color tone changes based on various light sources, compared with a subject that appears white under the sunlight.

Weather/ lighting	Daylight	Cloudy	Fluorescent	Incandescent
				
Characteristics of light	White	Bluish	Green-tinged	Reddish

White balance is a feature that adjusts the color tone to approximate what you see. Use this feature when the color tone of the image did not come out as you expected, or when you want to change the color tone on purpose for photographic expression.







Note

- If the only light source available is a mercury lamp or a sodium lamp, the camera will not be able to acquire the accurate white balance because of the characteristics of the light source. Use the flash in such cases.

Adjusting the white balance to suit a specific light source (Auto/Preset white balance)

Fn button → **[White balance]** → **Select the desired setting**

- When [AWB] is not selected, you can finely adjust the color tone with ◀/▶ on the controller. Adjusting it toward + turns the image reddish and adjusting it toward – turns the image bluish.

AWB (Auto WB)	The camera automatically detects a light source and adjusts the color tones.
 (Daylight)	If you select an option to suit a specific light source, the color tones are adjusted for the light source (preset white balance).
 (Shade)	
 (Cloudy)	
 (Tungsten)	
 (Fluorescent)	
 (Flash)	

Shooting techniques

- Use the white balance bracket function if you cannot get the desired color in the selected option (page 92).
- When you select [5500K] (ColorTemperature) or [00] (Color filter), you can adjust the value to the desired value (below).
- When you select  (Custom), you can register your setting (page 85).

Setting the color temperature and a filter effect (Color Temperature/Color filter)

Fn button → [White balance] → [5500K] (ColorTemperature) or [00] (Color filter)

- To set the color temperature, select the value with ◀/▶.
- To set the color filter, select the compensation direction with ◀/▶.

Note

- Since color meters are designed for film cameras, the values differ under fluorescent/sodium lamp/mercury lamps. We recommend that you use the custom white balance or do a test shooting.

5500K*¹ (ColorTemperature)	Sets the white balance by the color temperature. The higher the number, the more reddish the image and the lower the number, the more bluish the image.
00*² (Color filter)	Achieves the effect of CC (Color Compensation) filters for photography. Based on using the set color temperature as the standard, the color can be compensated to G (Green) or M (Magenta).

*¹ The value is the color temperature value currently selected.

*² The value is the Color filter value currently selected.

Registering the color tones (Custom white balance)

In a scene where the ambient light consists of multiple types of light source, use of custom white balance is recommended in order to accurately reproduce the whiteness.

1 Fn button → [White balance] → 

2 Select [ SET] with ◀/▶ on the controller.

3 Hold the camera so that the white area fully covers the spot-metering circle and press the shutter button down.

The shutter clicks and the calibrated values (ColorTemperature and Color filter) are displayed.

4 Press the center of the controller.

The monitor returns to the recording information display with the memorized custom white balance setting retained.

- The custom white balance setting is registered in this operation is effective until a new setting is registered.
-

Note

- The message “Custom WB error” indicates that the value is beyond the expected range. (When the flash is used on a subject in close proximity or a subject with a bright color is in the frame.) If you register this value, the  indicator turns yellow on the recording information display on the LCD monitor. You can shoot at this point, but it is recommended that you set the white balance again to get a more correct white balance value.

To call the custom white balance setting

Fn button → [White balance] →  (Custom)

Note

- If the flash is used when the shutter button is pressed, a custom white balance is registered with the flash light taken into account. Take pictures with the flash in later shootings.

Image processing

Correcting the brightness of the image (D-Range Optimizer)

Fn button → [D-RangeOptimizer] → **Select the desired setting**

D-Off (Off)	No compensation.
D-R (Standard)	When there is a sharp contrast of light and shadow between the subject and the background, which is common when shooting into the sun, the camera attenuates the contrast across the entire image to produce an image with proper brightness and contrast.
D-RH (Advanced)	By dividing the image into small areas, the camera analyses the contrast of light and shadow between the subject and the background, producing the image with the optimal brightness and gradation.

- **D-RH (Advanced)** of D-Range Optimizer has no effect on RAW files. Correct images using the D-Range Optimizer function of “Image Data Converter SR.”

Selecting your desired image processing (Creative Style)

MENU button → **1** → [Creative Style] → **Select the desired setting**

- When you want to adjust (Contrast), (Saturation), or (Sharpness), select the desired item with / , then adjust the value with / .

Std.† (Standard)	For shooting various scenes with rich gradation and beautiful colors.
Vivid† (Vivid)	The saturation and contrast are heightened for shooting striking images of colorful scenes and subjects such as flowers, spring greenery, blue sky, or ocean views.
Port.† (Portrait)	For shooting the skin color in a soft tone, ideally suited to shooting portraits.
Land.† (Landscape)	The saturation, contrast, and sharpness are heightened for shooting vivid and crisp scenery. Distant landscapes also stand out more.

Night † (Night view)	The contrast is attenuated for shooting a nightscape that is more faithful to the real view.
Sunset † (Sunset)	For shooting the beautiful red of the setting sun.
B/W † (B/W)	For shooting images in black and white monotone.
Adobe † (Adobe RGB)	For shooting images in Adobe RGB color space.

● (Contrast), ⊗ (Saturation), and □ (Sharpness) can be adjusted for each Creative Style item.

● (Contrast)	The difference of light and shadow in an image (gradation). Increase the value to get an image with strong contrast. Decrease the value for a softer finish.
⊗ (Saturation)	The vividness of the colors. Increase the value for an image with deep and vivid colors. Decrease the value for a quiet finish.
□ (Sharpness)	The degree of highlighting of the contours. Increase the value for a more crisp finish. Decrease the value for a softer finish.

About Adobe RGB color space

Adobe RGB color space has a wide range of color reproduction, compared to sRGB that is the standard color space of the digital camera. If the main purpose is to print out the image, especially when a large part of the subject is vivid green or red, Adobe RGB is more effective than other sRGB color modes.

- The file name of the image starts with “_DSC.”

Notes

- If the Scene Selection is used, you cannot change the settings for the Creative Style.
- When **B/W**† (B/W) is selected, you cannot adjust the saturation.
- **Adobe**† (Adobe RGB) is for applications or printers that support color management and DCF2.0 option color space. Using some applications or printers that do not support them may result in or print images that do not reproduce faithful color.
- When displaying images that were recorded with **Adobe**† (Adobe RGB) on the camera or non-Adobe RGB-compliant devices, the images are displayed with low saturation.

☺/📷 **Selecting the drive mode**

This camera has five drive modes, such as single-shot advanced, continuous advanced. Use them for your purpose.

Shooting single shot

This mode is for normal shooting.

☺/📷 **button** → 📷 (Single-shot adv.)

Shooting continuously

The camera records the images continuously at a maximum of 3 images per second*.

* Our measurement conditions. The speed of continuous shooting is slower, depending on shooting conditions.

1 ☺/📷 **button** → 📷 (Continuous adv.)

2 Adjust the focus and shoot the subject.

- When you press and hold the shutter button, the recording continues.
- The number of images that can be shot continuously is indicated in the viewfinder.

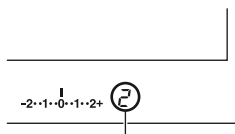

The number of images that can be shot continuously

The maximum number of continuous shots

The number of continuous shooting images obtainable has an upper limit.

Fine/Standard*	No limit (Until the memory card is full)
RAW & JPEG	3 images
RAW	6 images

* The shooting speed becomes a little slower for fourth image or later.

Using the self-timer

The 10-second self-timer is convenient when the photographer appears in a photo and the 2-second self-timer is convenient to reduce the camera shake.



1 / button → (Self-timer) → Select the desired seconds

- The number after  is the number of seconds that is currently selected.

2 Adjust the focus and shoot the subject.

- When the self-timer is activated, audio signals and the self-timer lamp indicate the condition. The self-timer lamp flashes quickly and the audio signal sounds quickly right before the shooting.

To cancel the self-timer

To cancel the activated self-timer, press the  /  button.

Note

- When you press the shutter button without looking into the viewfinder, use the eyepiece cover (page 27).

Shooting images with the exposure shifted (Exposure bracket)



Base exposure



- direction



+ direction

Bracket shooting allows you to shoot several images, each with different degrees of exposure. This camera is equipped with an auto bracket function. Specify the value of deviation (steps) from the base exposure, and the camera shoots while automatically shifting the exposure. You can choose an image that has the brightness you like after shooting is finished.

1 button → Desired bracket → Desired bracket step

2 Adjust the focus and shoot the subject.

The base exposure is set at the first shot in the bracket.



BRK C * (Bracket: Cont.)	Shoots three images with the exposure shifted by a selected step. Press and hold the shutter button until the recording stops.
BRK S * (Bracket: Single)	Shoots three images with the exposure shifted by a selected step. Press the shutter button shot by shot.

* _ _ EV beneath **BRK C** / **BRK S** is the step currently selected.

Notes

- When the mode dial is set to M, the exposure is shifted by adjusting the shutter speed. If you shift the exposure by adjusting the aperture value, press and hold the AEL button.
- When you adjust the exposure, the exposure is shifted based on the compensated value.
- The bracket cannot be used when the recording mode is set to AUTO or Scene Selection.

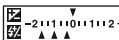
The EV scale in bracket shooting

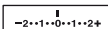
	Ambient bracket 0.3 steps, three shots Exposure compensation 0	Flash bracket 0.7 steps, three shots Flash compensation -1.0
LCD monitor	 Shown in the top row.	 Shown in the bottom row.
Viewfinder		

- In ambient* bracket shooting, the EV scale appears in the viewfinder, too, but it does not appear in flash bracket shooting.
- When the bracket shooting starts, the indexes that indicate already recorded images start to disappear one by one.

- When Single bracket is selected, if the shutter button is pressed halfway down and released, “br 1” appears for the ambient light bracket and “Fbr 1” appears for the flash bracket in the viewfinder. When bracket shooting starts, it indicates what number the next frame is, for instance, “br 2,” “br 3.”
- * Ambient light: Any light other than the flash light that shines on the scene for an extended period of time, such as natural light, a light bulb, or a fluorescent light.

Shooting with white balance shifted (WB bracket)

Based on the selected white balance, and color temperature/color filter, three images are taken.

1  button → **BRKWB (WB bracket)** → **Select the desired setting**

2 Adjust the focus and shoot the subject.

BRKWB *1 (WB bracket)	Shoots three images with the white balance shifted. When Lo is selected, it is shifted by 10 mired*2, and when Hi is selected, it is shifted by 20 mired. One shot records three images.
------------------------------	--

*1 The value beneath **BRKWB** is the value currently selected.

*2 Mired: a unit to indicate the color conversion quality in color temperature filters.

Playing back images

The last recorded image is displayed on the LCD monitor.

1 Press the  button.

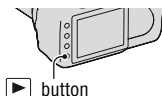

2 Select an image with /▶ on the controller.

To return to the shooting mode

Press the  button again.

To switch the recording data display

Press the DISP button.

Each time you press the DISP button, the screen changes as follows.

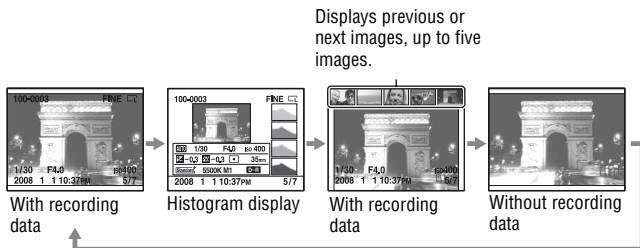

Note

- The DISP button switches the recording data display on and off in other playback modes, such as on an enlarged screen.

To select the orientation when playing back an image recorded in the portrait position

MENU button →  **2** → [PlaybackDisplay] → Select the desired setting

Note

- When you play back the image on a TV or a computer, the image will be displayed in the portrait position even if [Manual rotate] is selected.

Rotating an image

- 1 Display the image you want to rotate, then press the  button.**

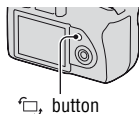

- 2 Press the center of the controller.**

The image is rotated counter-clockwise. When you want to do another rotation, repeat step 2.

- Once you rotate the image, the image is played back in the rotated position, even if you turn off the power.

To return to the normal playback screen

Press the  button.

Note

- When you copy rotated images to a computer, “Picture Motion Browser” contained on the CD-ROM (supplied) can display the rotated images correctly. However, the images may not be rotated depending on the software.



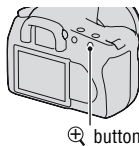

Enlarging images

An image can be enlarged for closer examination. This is convenient to check the focus condition of a recorded image.

- 1 Display the image you want to enlarge, then press the  button.**



2 Zoom the image in or out with the or button.

- You can select the portion you want to enlarge with /// on the controller.
- Rotating the control dial switches the image at the same display magnification. When you shoot multiple images with the same composition, you can compare their focus conditions.
- Each time you press the center of the controller, the screen changes between the zoomed screen and the full-screen mode.

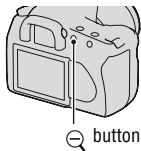

To cancel the enlarged playback

Press the  button so that the image returns to the normal size.

To enlarge the image centering around the previously selected point

You can select a portion of an image first, then enlarge the portion.

1 Display the image you want to enlarge, then press the button.

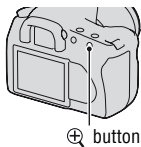

2 Press the center of the controller.

The red frame appears.

3 Move the red frame to the center point you want to enlarge with /// on the controller.

4 Scale up or down the red frame to specify the portion you want to enlarge with the \oplus or \ominus button.

5 Press the center of the controller.

The portion inside the red frame is enlarged.

- Press the center of the controller to return to the previous screen.
 - To cancel the enlarged playback, press the \blacktriangleright button.
-

Scaling range

The scaling range is as follows.

Image size	Scaling range
L	Approx. $\times 1.1 - \times 12$
M	Approx. $\times 1.1 - \times 9.1$
S	Approx. $\times 1.1 - \times 6.1$

Switching to the display of the image list

1 Press the  button.

The screen changes to the index screen.

 button



2 Press the DISP button repeatedly to select the desired screen format.

- The screen changes in the following order: 9 images \rightarrow 25 images \rightarrow 4 images

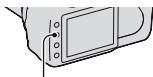

DISP button

To return to the single-image screen

Press the  button or the center of the controller when you select the desired image.

To select a folder

- 1 Select the folder bar with ◀/▶ on the controller, then press the center.



Folder bar

- 2 Select the desired folder with ▲/▼, then press the center.

Playing back images automatically (Slide show)

MENU button →  2 → [Slide show]

Plays back recorded images in order (Slide show). The slide show automatically stops after all the images have been played back.

- You can view the previous/next image with ◀/▶ on the controller.

To pause the slide show

Press the center of the controller. Pressing again starts the slide show again.

To end in the middle of the slide show

Press the MENU button.

To choose the interval between the images in slide show

MENU button →  2 → [Interval] → Select the desired number of seconds

Checking the information of recorded images

Each time you press the DISP button, the information display changes (page 93).

Basic information display

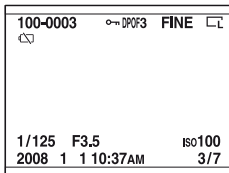

Display	Indication
100-0003	Folder - file number (124)
Protect (101)	Protect (101)
DPOF3	DPOF set (133)
RAW RAW+J FINE STD	Image quality (106)
Image size (106)/Aspect ratio (106)	Image size (106)/Aspect ratio (106)
Battery remaining warning (17)	Battery remaining warning (17)
1/125	Shutter speed (61)
F3.5	Aperture (59)
ISO100	ISO sensitivity (82)
2008 1 1 10:37AM	Date of recording
3/7	File number/total number of images

Histogram display

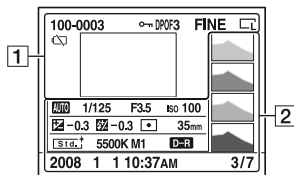

1

Display	Indication
100-0003	Folder - file number (124)
	Protect (101)
DPOF3	DPOF set (133)
RAW RAW+J FINE STD	Image quality (106)
	Image size (106)/Aspect ratio (106)
	Battery remaining warning (17)

2

Display	Indication
	Histogram (100)
AUTO P A S M 	Mode dial (48)
1/125	Shutter speed (61)
F3.5	Aperture (59)
ISO100	ISO sensitivity (82)
-0.3	EV scale (63, 91)
-0.3	Flash compensation (79)
	Metering mode (80)

Display	Indication
35mm	Focal length (141)
	Creative Style (87)
AWB +1 5500K M1	White balance (Auto, Preset, Color temperature, Color filter, Custom) (83)
	D-Range Optimizer (87)
2008 1 1 10:37AM	Date of recording
3/7	File number/total number of images

How to check the histogram

A histogram is the luminance distribution that shows how many pixels of a particular brightness exist in the picture.

When the image has a high-key or low-key portion, that portion is flashed on the histogram display (Luminance limit warning).

The exposure compensation will change the histogram accordingly. The right illustration is an example.

Shooting with the exposure compensation on the positive side brightens the whole picture, making the entire histogram shift to the bright side (right side). If the exposure compensation is applied on the negative side, the histogram will shift to the other side. Both ends of the histogram show a high-key or low-key portion. It is impossible to restore these area with a computer later. Adjust the exposure if necessary and shoot again.

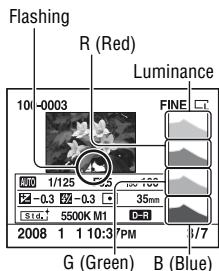
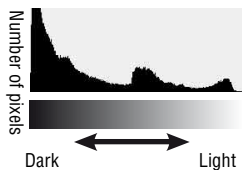

Protecting images (Protect)

You can protect images against accidental erasure.

Protecting selected images/canceling the protection of the selected images

1 MENU button →  1 → [Protect] → [Marked images]

2 Select the image you want to protect with ◀/▶ on the controller, then press the center of the controller.

A  mark appears on the selected image.

- To cancel a selection, press the center again.

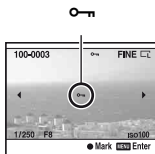

3 To protect other images, repeat step 2.

4 Press the MENU button.

5 Select [OK] with ▲ on the controller, then press the center of the controller.

Protecting all the images/canceling the protection of all the images

MENU button →  1 → [Protect] → [All images] or [Cancel all] → [OK]

Deleting images (Delete)

Once you have deleted an image, you cannot restore it. Check whether you delete the image or not beforehand.

Note

- Protected images cannot be deleted.

Deleting the image that is currently displayed

- 1 Display the image you want to delete and press the  button.**

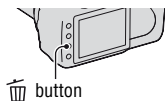

- 2 Select [Delete] with \blacktriangle , then press the center of the controller.**

Deleting the selected images

- 1 MENU button \rightarrow  1 \rightarrow [Delete] \rightarrow [Marked images]**

- 2 Select the images you want to delete with the controller, then press the center of the controller.**

A  mark appears on the selected image.

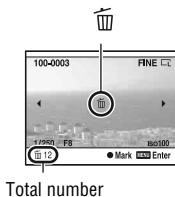

- 3 To delete other images, repeat step 2.**

- 4 Press the MENU button.**

5 Select [Delete] with ▲ on the controller, then press the center of the controller.

Deleting all the images in the folder

1 Press the  button.

2 Select the folder bar with ◀ on the controller.



Folder bar

3 Press the center of the controller, then select the folder you want to delete with ▲/▼.

4 Press the  button.

5 Select [Delete] with ▲, then press the center of the controller.

Deleting all the images all at once

MENU button →  1 → [Delete] → [All images] → [Delete]

Note

- It may take a long time to delete a lot of images by selecting [All images]. It is recommended that you delete images on a computer or format the memory card using the camera.

Viewing images on a TV screen

- 1 Turn off both your camera and the TV, and connect the camera to the TV.

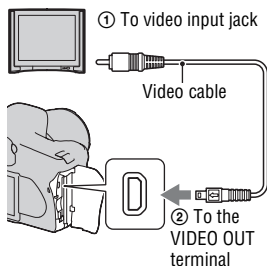

- 2 Turn on the TV and switch the input.

- See also the operating instructions supplied with the TV.

- 3 Turn on the camera, and press the  button.

Images shot with the camera appear on the TV screen.

Select the desired image with ◀/▶ on the controller.

- The LCD monitor on the rear of the camera does not turn on.

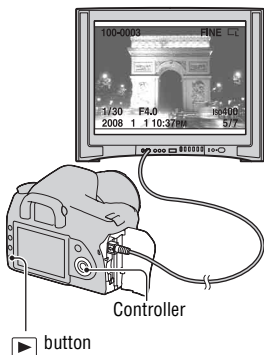

- If you connect the camera to a Sony TV that is compatible with the “PhotoTV HD” feature using the supplied USB cable, you can enjoy higher quality images on the TV.

To use your camera abroad

It may be necessary to switch the video signal output to match that of your TV system.

MENU button →  **1** → **[Video output]** → **Select the desired setting**

NTSC	Sets the video output signal to NTSC mode (e.g., for the USA, Japan).
PAL	Sets the video output signal to PAL mode (e.g., for Europe).

On TV color systems

If you want to view images on a TV screen, you need a TV with a video input jack and the video cable. The color system of the TV must match that of your digital still camera. Check the following lists for the TV color system of the country or region where the camera is used.

NTSC system

Bahama Islands, Bolivia, Canada, Central America, Chile, Colombia, Ecuador, Jamaica, Japan, Korea, Mexico, Peru, Surinam, Taiwan, the Philippines, the U.S.A., Venezuela, etc.

PAL system

Australia, Austria, Belgium, China, Czech Republic, Denmark, Finland, Germany, Holland, Hong Kong, Hungary, Italy, Kuwait, Malaysia, New Zealand, Norway, Poland, Portugal, Singapore, Slovak Republic, Spain, Sweden, Switzerland, Thailand, United Kingdom, etc.

PAL-M system

Brazil

PAL-N system

Argentina, Paraguay, Uruguay

SECAM system

Bulgaria, France, Guiana, Iran, Iraq, Monaco, Russia, Ukraine, etc.

Setting image size and image quality

Image size

MENU button →  **1** → **[Image size]** → **Select the desired size**

[Aspect ratio]: [3:2]

L:10M	3872 × 2592 pixels
M:5.6M	2896 × 1936 pixels
S:2.5M	1920 × 1280 pixels

[Aspect ratio]: [16:9]

L:8.4M	3872 × 2176 pixels
M:4.7M	2896 × 1632 pixels
S:2.1M	1920 × 1088 pixels

Note

- When you select a RAW file with [Quality], the image size of the RAW file corresponds to L. This size is not displayed on the LCD monitor.

Aspect ratio

MENU button →  **1** → **[Aspect ratio]** → **Select the desired ratio**

3:2	A normal ratio.
16:9	An HDTV ratio.

Quality

MENU button →  **1** → **[Quality]** → **Select the desired setting**

RAW (RAW)	File format: RAW (raw data) This format is not achieved by digital processing. Select this format to process images on a computer for professional purposes. <ul style="list-style-type: none">• The image size is fixed to the maximum size. The image size is not displayed on the LCD monitor.
------------------	--

RAW+J (RAW & JPEG)	File format: RAW (raw data) + JPEG A RAW image and a JPEG image are created at the same time. This is suitable when you need two image files, a JPEG for viewing, and a RAW for editing. The image quality is fixed to [Fine] and the image size is fixed to [L].
FINE (Fine)	File format: JPEG
STD (Standard)	The image is compressed in the JPEG format when recorded. The higher the compression rate, the smaller the file size. This will allow more files to be recorded in one memory card, but the image quality will be lower.

Note

- For details on the number of images that can be taken when the image quality is changed, see page 29.

About RAW files

You need the “Image Data Converter SR” software included on the CD-ROM (supplied) in order to open a RAW file recorded on this camera. With this software, a RAW file can be opened and converted to a common format, such as JPEG or TIFF, and its white balance, color saturation, contrast, etc., can be readjusted.

- Recording a RAW format image entails the following limitation.
 - The RAW file cannot be printed using a DPOF (print) designated printer or a PictBridge compliant printer.
- You cannot verify the effects of D-Range Optimizer other than those of **D-R** (Standard) if you play back and enlarge an image recorded in RAW format.

Setting the method for recording on a memory card

Selecting the method for assigning file numbers to images

MENU button →  **2** → **[File number]** → **Select the desired setting**

Series	The camera does not reset numbers and assigns numbers to files in sequence until the number reaches “9999.”
Reset	The camera resets numbers in the following cases and assigns numbers to files from “0001.” <ul style="list-style-type: none">– When the folder format is changed.– When all the images in the folder are deleted.– When the memory card is replaced.– When the memory card is formatted.

Selecting the folder name format

The recorded images are stored in the automatically-created folder in the DCIM folder on the memory card.

MENU button →  **2** → **[Folder name]** → **Select the desired setting**

Standard form	The folder name format is as follows: folder number + MSDCF. Example: 100MSDCF
Date form	The folder name format is as follows: folder number + Y (the last digit)/MM/DD. Example: 10080405

Creating a new folder

You can create a folder in a memory card for recording images. A new folder is created with a number incremented one higher than the largest number currently used, and the folder becomes the current recording folder.

MENU button →  **2** → **[New folder]**

Selecting the recording folder

When a standard form folder is selected and there are two or more folders, you can select the recording folder to be used to record images.

MENU button →  **2** → **[Select folder]** → **Select the desired folder**

Note

- You cannot select the folder when you are setting [Date form].

Formatting the memory card

Note that formatting irrevocably erases all data on a memory card, including protected images.

MENU button →  **1** → **[Format]** → **[OK]**

- During the format, the access lamp lights up. Do not eject the memory card while the lamp is lit.

Notes

- Format the memory card using the camera. If you format it on a computer, the memory card may not be usable with the camera, depending on the format type used.
- Formatting may take several minutes depending on the memory card.

Changing the noise reduction setting

Disabling the noise reduction at a long exposure shooting

When you set the shutter speed to a second or longer (Long exposure shooting), the noise reduction is turned on for the same duration as the shutter was open.

This is to reduce the grainy noise typical in a long exposure. When noise reduction is in progress, a message appears and you cannot take another picture. Select [On] to prioritize the image quality. Select [Off] to prioritize the timing of shooting.

MENU button →  **2** → **[Long exp.NR]** → **[Off]**

Note

- Noise reduction is not performed on continuous shooting or continuous bracketing even when it is set to [On].

Disabling the noise reduction at a high ISO sensitivity

When shooting with the ISO set at 1600 or above, the camera reduces the noise that becomes more noticeable when the camera sensitivity is high. Select [On] to prioritize the image quality. Select [Off] to prioritize the timing of shooting.

MENU button →  **2** → **[High ISO NR]** → **[Off]**

Note

- Noise reduction is not performed on continuous shooting or continuous bracketing even when it is set to [On].

Changing the conditions under which the shutter can close

Prioritizing the shutter opportunity

To prioritize the shutter opportunity, select [Release] so you can shoot without acquiring a sharp focus.

To shoot with a sharp focus, select [AF].

MENU button →  **2** → [Priority setup] → [Release]

Changing the functions of the button and dial

Changing the function of the AEL button

The function of the AEL button can be selected from the following two functions:

- Holding the locked exposure value by pressing the AEL button while the button is held down ([AEL hold]).
- Holding the locked exposure value by pressing the AEL button until the button is pressed again ([AEL toggle]).

MENU button →  1 → [AEL button] → Select the desired setting

Notes

- While the exposure value is locked,  appears on the LCD monitor and in the viewfinder. Be careful not to reset the setting.
- The “Hold” and “Toggle” settings affect the manual shift (page 64) in the manual mode.

Changing the function of the control dial

When the recording mode is M (Manual exposure) or P (Program shift), you can set the camera so that the adjustable item (the shutter speed or the aperture value) can be selected using only the control dial.

It is convenient that you select commonly-used one when adjusting the exposure.

MENU button →  1 → [Ctrl dial setup] → Select the desired setting

Changing other settings

Setting the sound on/off

Selects the sound produced when the shutter is locked, during self-timer countdown, etc.

MENU button →  2 → **[Audio signals]** → **Select the desired setting**

Setting the time to turn the camera to the power save mode

You can set the time to turn the camera to the power saving mode (Power save). Pressing the shutter button halfway down returns the camera to the shooting mode.

MENU button →  1 → **[Power save]** → **Select the desired time**

Note

- Regardless of the setting here, the camera turns to power save mode after 30 minutes when the camera is connected to a TV.

Setting the date

MENU button →  1 → **[Date/Time setup]** → **Set up the date and time**

Selecting the language

MENU button →  1 → **[ Language]** → **Select the language**

Setting the LCD monitor

Setting the brightness of the LCD monitor

MENU button →  **1** → [LCD brightness] → **Select the desired setting**

- On the recording information or playback screen, you can adjust the brightness by pressing the DISP button a little longer.

Setting the displayed time of the image right after shooting (Auto review)

You can check the recorded image on the LCD monitor right after the shooting. You can change the displayed time.

MENU button →  **1** → [Auto review] → **Select the desired setting**

Note

- In auto review, the image will not be displayed in the vertical position even if you shot the image in a vertical position (page 93).

Setting the displayed time of the LCD monitor during shooting

During shooting, the recording information display appears on the LCD monitor. You can change the displayed time of the display.

MENU button →  **1** → [Info.disp.time] → **Select the desired setting**

Keeping on the LCD monitor while looking into the viewfinder

In the default setting, while looking into the viewfinder, the LCD monitor is turned off to prevent the battery pack wearing down.

If you want to turn on the LCD monitor while looking into the viewfinder, select [Off].

MENU button →  **1** → **[Auto off w/ VF]** → **[Off]**

Note

- Regardless of the setting in this menu, the recording information display automatically turns off after a set duration (five seconds in the default setting) (page 37).

Resetting to the default

Resetting the functions used for shooting to the default setting

You can reset the main functions of the recording mode when the mode dial is set to P, A, S, or M.

MENU button →  **2** → **[Rec mode reset]** → **[OK]**

The items to be reset are as follows.

Items	Reset to
Exposure compensation (78)	±0.0
Metering mode (80)	Multi segment
Autofocus mode (69)	AF-A
Drive mode (89)	Single-shot adv.
White balance (83)	AWB (Auto white balance)
ColorTemperature/Color filter (84)	5500K, Color filter 0
Custom white balance (85)	5500K
ISO (82)	AUTO
Image size (106)	L:10M
Aspect ratio (106)	3:2
Quality (106)	Fine
D-RangeOptimizer (87)	Standard
Creative Style (87)	Standard
Flash mode (74)	Fill-flash (differs based on whether the built-in flash is open or not)
Flash control (79)	ADI flash
Flash compens. (79)	±0.0
Priority setup (111)	AF
AF illuminator (73)	Auto
Long exp.NR (110)	On
High ISO NR (110)	On

Resetting the main functions of the camera to the default setting

You can reset the main functions of the camera.

MENU button →  **3** → **[Reset default]** → **[OK]**

The items to be reset are as follows.

Items	Reset to
Exposure compensation (78)	±0.0
Metering mode (80)	Multi segment
Autofocus mode (69)	AF-A
Recording information display (37)	Enlarged display
Drive mode (89)	Single-shot adv.
White balance (83)	AWB (Auto white balance)
ColorTemperature/Color filter (84)	5500K, Color filter 0
Custom white balance (85)	5500K
ISO (82)	AUTO
Playback display (93)	Single-image screen (with recording data)
Image size (106)	L:10M
Aspect ratio (106)	3:2
Quality (106)	Fine
D-RangeOptimizer (87)	Standard
Creative Style (87)	Standard
Flash mode (74)	Fill-flash (differs based on whether the built-in flash is open or not)
Flash control (79)	ADI flash
Flash compens. (79)	±0.0
Priority setup (111)	AF
AF illuminator (73)	Auto
Long exp.NR (110)	On
High ISO NR (110)	On

Custom menu

Items	Reset to
Eye-Start AF (69)	On
AEL button (112)	AEL hold
Ctrl dial setup (112)	Shutter speed
Red eye reduc. (73)	Off
Auto review (114)	2 sec
Auto off w/ VF (115)	On

Playback menu

Items	Reset to
Date imprint (134)	Off
PlaybackDisplay (93)	Auto rotate
Slide show (97)	3 sec

Setup menu

Items	Reset to
LCD brightness (114)	±0
Info.disp.time (114)	5 sec
Power save (113)	1 min
File number (108)	Series
Folder name (108)	Standard form
USB connection (120, 135)	Mass Storage
Audio signals (113)	On

Copying images to your computer

This section describes how to copy images in a memory card to a computer connected using a USB cable.

Recommended computer environment

The following environment is recommended for a computer connected to the camera to import images.

■ Windows

OS (pre-installed): Microsoft Windows 2000 Professional SP4/ Windows XP* SP2/Windows Vista*

- Operation is not assured in an environment based on an upgrade of the operating systems described above or in a multi-boot environment.

* 64-bit editions and Starter (Edition) are not supported.

USB jack: Provided as standard

■ Macintosh

OS (pre-installed): Mac OS X (v10.1.3 or later)

USB jack: Provided as standard

Notes on connecting your camera to a computer

- Operations are not guaranteed for all the recommended computer environments mentioned above.
- If you connect two or more USB devices to a single computer at the same time, some devices, including your camera, may not operate, depending on the types of USB devices you are using.
- Operations are not guaranteed when using a USB hub or an extension cable.
- Connecting your camera using a USB interface that is compatible with Hi-Speed USB (USB 2.0 compliant) allows advanced transfer (high speed transfer) as this camera is compatible with Hi-Speed USB (USB 2.0 compliant).
- When your computer resumes from a suspend or sleep mode, communication between your camera and your computer may not recover at the same time.

Stage 1: Connecting the camera and your computer

1 Insert a memory card with recorded images into the camera.

2 Insert the sufficiently charged battery pack in the camera, or connect the camera to a wall outlet (wall socket) with the AC Adaptor/charger (not supplied).

- When you copy images to your computer using insufficient battery pack, copying may fail or image data may become corrupted if the battery pack shuts down too soon.

3 Turn on the camera and the computer.

4 Check that [USB connection] in  2 is set to [Mass Storage].

5 Connect the camera and your computer.

- The AutoPlay wizard appears on the desktop.

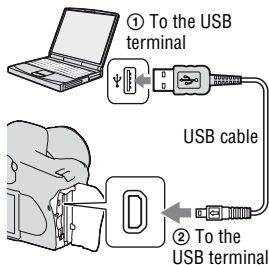

Stage 2: Copying images to a computer

For Windows

This section describes an example of copying images to a “My Documents” (For Windows Vista: “Documents”) folder.

1 Click [Copy pictures to a folder on my computer using Microsoft Scanner and Camera Wizard] → [OK] as the wizard screen appears automatically on the desktop.

- When the wizard screen does not appear, click [My Computer] → [Removable Disk].

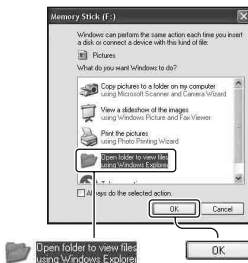

2 Double-click [DCIM].

- In that case, you can also import images using “Picture Motion Browser.”

3 Double-click the folder where the image files you want to copy are stored.

Then, right-click an image file to display the menu and click [Copy].

- On the storage destination of the image files, see page 124.

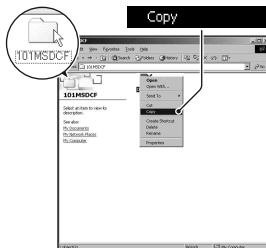

4 Double-click the [My Documents] (For Windows Vista: [Documents]) folder. Then, right-click on the “My Documents” window to display the menu and click [Paste].

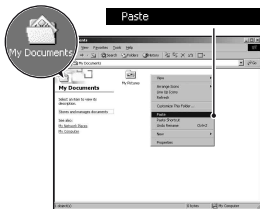

The image files are copied to the “My Documents” (For Windows Vista: “Documents”) folder.

- When an image with the same file name exists in the copy destination folder, the overwrite confirmation message appears. When you overwrite an existing image with a new one, the original file data is deleted. To copy an image file to the computer without overwriting, change the file name to a different name and then copy the image file. However, note that if you change the file name, you may not be able to play back that image with your camera (page 125).

For Macintosh

1 Double-click the newly recognized icon → [DCIM] → the folder where the images you want to copy are stored.

2 Drag and drop the image files to the hard disk icon.

The image files are copied to the hard disk.

Viewing images on your computer

For Windows

This section describes the procedure for viewing copied images in the “My Documents” (For Windows Vista: “Documents”) folder.

1 Click [Start] → [My Documents] (For Windows Vista: [Documents]).

- If you are using Windows 2000, double-click [My Documents] on the desktop.



2 Double-click the desired image file.

The image is displayed.

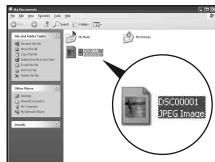

For Macintosh



Double-click the hard disk icon → the desired image file to open the image file.

Deleting the USB connection

Perform the procedures listed below beforehand when:

- Disconnecting the USB cable.
- Removing the memory card.
- Turning off the camera.

■ For Windows

Double-click  on the tasktray, then click  (USB Mass Storage Device) → [Stop]. Confirm the device on the confirmation window, then click [OK] → [OK] (unnecessary for Windows XP/Vista).
The device is disconnected.

■ For Macintosh

Drag and drop the drive icon or the icon of the memory card to the “Trash” icon.

The camera is disconnected from the computer.

Image file storage destinations and file names

The image files recorded with your camera are grouped as folders on the memory card.

Example: viewing folders on Windows XP

- A** Folders containing image data recorded using this camera. (The first three digits show the folder number.)
- B** You can create a folder by date form (page 108).
- You cannot record/play back any images in the “MISC” folder.
- Image files are named as follows. □□□□ (file number) stands for any number within the range from 0001 to 9999. The numerical portions of the name of a RAW data file and its corresponding JPEG image file are the same.
 - JPEG files: DSC0□□□□.JPG
 - JPEG files (Adobe RGB):
_DSC□□□□.JPG
 - RAW data file (other than Adobe RGB):
DSC0□□□□.ARW
 - RAW data file (Adobe RGB):
_DSC□□□□.ARW
- The extension may not be displayed depending on the computer.
- For more information about folders, see page 108.

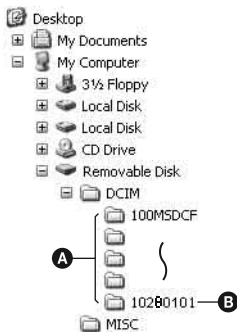

Copying images stored on a computer to a memory card and viewing the images

This section describes the process using a Windows computer as an example.

1 Right-click the image file, then click [Rename]. Change the file name to “DSC0□□□□.”

Enter a number from 0001 to 9999 for □□□□.

- If the overwrite confirmation message appears, enter a different number.
- An extension may be displayed depending on the computer settings. The extension for images is JPG. Do not change the extension.
- Step 1 is not necessary if the file name set with your camera has not been changed.

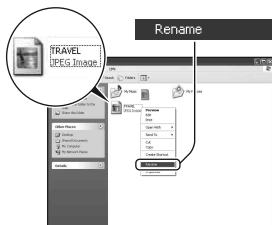

2 Copy the image file to the memory card folder in the following order.

- ① Right-click the image file, then click [Copy].
 - ② Double-click [Removable Disk] or [Sony MemoryStick] in [My Computer].
 - ③ Right-click the [□□□MSDCF] folder in the [DCIM] folder, then click [Paste].
- □□□ stands for any number within the range from 100 to 999.

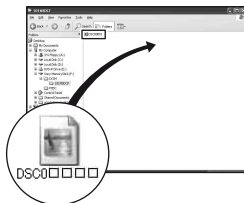

Notes

- You may be unable to play back some images depending on the image size.
- When an image file has been processed by a computer or when the image file was recorded using a model other than that of your camera, playback on your camera is not guaranteed.
- When there is no folder, first create a folder with your camera (page 109) and then copy the image file.

Using the software

To utilize images recorded with the camera, the following software is provided: “Picture Motion Browser,” “Image Data Converter SR,” “Image Data Lightbox SR” etc.

Note

- “Picture Motion Browser” is not compatible with Macintosh computers.

Recommended computer environment

■ Windows

Recommended environment for using “Picture Motion Browser”

OS (pre-installed): Microsoft Windows 2000 Professional SP4/Windows XP* SP2/Windows Vista*

* 64-bit editions and Starter (Edition) are not supported.

CPU/Memory: Pentium III 500 MHz or faster, 256 MB of RAM or more (Recommended: Pentium III 800 MHz or faster and 512 MB of RAM or more)

Hard Disk: Disk space required for installation—200 MB or more

Display: 1024 × 768 dots or more, High Color (16-bit color) or more

Recommended environment for using “Image Data Converter SR Ver.2”/“Image Data Lightbox SR”

OS (pre-installed): Microsoft Windows 2000 Professional SP4/Windows XP* SP2/Windows Vista*

* 64-bit editions and Starter (Edition) are not supported.

CPU/Memory: MMX Pentium III 1 GHz or faster is recommended, RAM 512 MB or more (RAM 1 GB or more is recommended.)

Virtual memory: 700 MB or more

Display: 1024 × 768 dots or more, High Color (16-bit color) or more

■ Macintosh

Recommended environment for using “Image Data Converter SR Ver.2”/“Image Data Lightbox SR”

OS (pre-installed): Mac OS X (v10.4)

CPU: Power Mac G4/G5 series (1.0 GHz or faster is recommended)/Intel Core Solo/Core Duo/Core 2 Duo or faster

Memory: 512 MB or more (1 GB or more is recommended.)

Display: 1024 × 768 dots or more, 32,000 colors or more

Installing the software



You can install the software (supplied) using the following procedure.

■ Windows

- Log on as Administrator.

1 Turn on your computer, and insert the CD-ROM (supplied) into the CD-ROM drive.

The installation menu screen appears.

- If it does not appear, double-click  (My Computer) →  (SONYPICUTIL) → [Install.exe].
- Under Windows Vista, the AutoPlay screen may appear. Select “Run Install.exe” and follow the instructions that appear on the screen to proceed with the installation.



2 Click [Install].

Follow the instructions on the screen.

3 Remove the CD-ROM after the installation is complete.

The following software is installed and shortcut icons appear on the desktop.

- Sony Picture Utility
“Picture Motion Browser”
- Sony Image Data Suite
“Image Data Converter SR”
“Image Data Lightbox SR”

After you install the software, a shortcut icon for the customers registration website is created on the desktop.

Once you register on the website, you can get secure and useful customer support.

<http://www.sony.net/registration/di/>

■ Macintosh

- Log on as Administrator for installation.
-

1 Turn on your Macintosh computer, and insert the CD-ROM (supplied) into the CD-ROM drive.

2 Double-click the CD-ROM icon.

3 Copy the [SIDS_INST.pkg] file in the [MAC] folder to the hard disk icon.

4 Double-click the [SIDS_INST.pkg] file in the copy-to folder.

Follow the instructions on the screen to complete the installation.

Note

- When the restarting confirmation message appears, restart the computer following the instructions on the screen.

Using “Picture Motion Browser”

Note

- “Picture Motion Browser” is not compatible with Macintosh computers.

With “Picture Motion Browser” you can:

- Import images shot with the camera and display them on the computer.
- Organize images on the computer on a calendar by shooting date to view them.
- Retouch (Red Eye Correction, etc.), print, and send still images as e-mail attachments, change the shooting date and more.
- Print or save still images with the date.
- Create a data disc using a CD burner drive or DVD burner drive.

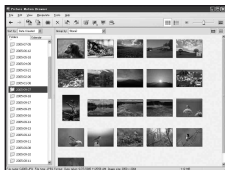

For details on “Picture Motion Browser,” refer to “Picture Motion Browser Guide.”

To start “Picture Motion Browser Guide,” click [Start] → [All Programs] (in Windows 2000, [Programs]) → [Sony Picture Utility] → [Help] → [Picture Motion Browser Guide].

To start “Picture Motion Browser”

Double-click the  (Picture Motion Browser) icon on the desktop.

Or, from the Start menu: Click [Start] → [All Programs] (in Windows 2000, [Programs]) → [Sony Picture Utility] → [Picture Motion Browser].

To exit the “Picture Motion Browser,” click  button on the upper-right corner of the screen.

Note

- The confirmation message of the Information tool appears on the screen when starting “Picture Motion Browser” for the first time. Select [Start]. This function informs you of news, such as software updates. You can change the setting later.

Using “Image Data Converter SR”

Note

- If you save an image as RAW data, the image is saved in the ARW2.0 format.

With “Image Data Converter SR Ver.2.0” you can:

- Edit images recorded in RAW mode with various corrections, such as tone curve, and sharpness.
- Adjust images with the white balance, exposure, and creative style, etc.
- Save the images displayed and edited on a computer. You can either save the image as RAW data or save it in the general file format.
- For details on “Image Data Converter SR,” refer to the Guide.

To start the Guide, click [Start] → [All Programs] (in Windows 2000, [Programs]) → [Sony Image Data Suite] → [Help] → [Image Data Converter SR Ver.2].

To start up “Image Data Converter SR Ver.2.0”

■ Windows

Double-click the shortcut of “Image Data Converter SR Ver.2.0” on the desktop.

When starting up from the Start menu, click [Start] → [All Programs] (For Windows 2000: [Programs]) → [Sony Image Data Suite] → [Image Data Converter SR Ver.2.0].

To exit, click the  button on the upper-right corner of the screen.

■ Macintosh

Double-click [Image Data Converter SR Ver.2] in the [Sony Image Data Suite] folder from the [Application] folder.

To exit, click [Quit Image Data Converter SR] from the [IDC SR] menu.

Using “Image Data Lightbox SR”

With “Image Data Lightbox SR” you can:

- Display and compare RAW/JPEG images recorded with this camera.
- Rate the images on a scale of five.
- Display an image in “Image Data Converter SR” and make adjustments to it.
- For details on “Image Data Lightbox SR,” refer to the Guide.

To start the Guide from the Start menu, click [Start] → [All Programs] (in Windows 2000, [Programs]) → [Sony Image Data Suite] → [Help] → [Image Data Lightbox SR].

To start up “Image Data Lightbox SR”

■ Windows

Double-click [Image Data Lightbox SR] on the desktop.

When starting up from the Start menu, click [Start] → [All Programs] (For Windows 2000: [Programs]) → [Sony Image Data Suite] → [Image Data Lightbox SR].

To exit, click the  button on the upper-right corner of the screen.

The dialogue used for saving a collection appears.

■ Macintosh

Double-click [Image Data Lightbox SR] in the [Sony Image Data Suite] folder from the [Application] folder.

To exit, click [Quit Image Data Lightbox SR] from the [Image Data Lightbox SR] menu.

Specifying DPOF

Using the camera, you can specify the images and the number of images to print before you print images at a shop or with your printer. Follow the procedure below.

DPOF specifications are left with images after printing. It is recommended that you unspecify them after printing.

Specifying /unspecifying DPOF on selected images

1 MENU button → 1 → [DPOF setup] → [Marked images]

An image is displayed on the single screen.

2 Select the image with /▶ on the controller.

3 Select the number of sheets with the ⊕/⊖ buttons.

- To unspecify DPOF, set the number to “0.”

4 Press the MENU button.

5 Select [OK] with ▲ on the controller, then press the center of the controller.

Notes

- You cannot specify DPOF on RAW data files.
- You can specify any number up to 9.
- If you unspecify DPOF, the index print is also canceled.

Specifying/unspecifying DPOF on all the images

MENU button →  1 → [DPOF setup] → [All images] or [Cancel all] → [OK]

Dating images

You can date images when printing them. The position of the date (inside or outside the image, character size, etc.) depends on your printer.

MENU button →  **1** → **[DPOF setup]** → **[Date imprint]** → **[On]**

Note

- This function may not be provided, depending on the printer.

Creating an index print

You can create an index print of all the images in the memory card.

MENU button →  **1** → **[DPOF setup]** → **[Index print]** → **[Create index]**

Notes

- The number of images that can be printed on one sheet and the format depend on the printer. RAW images do not print in index print.
- The images you shoot after setting the index print are not included in the index print. It is recommended that you create the index print just before printing it.
- If you do not specify DPOF, the index print is also canceled.

Printing images by connecting the camera to a PictBridge compliant printer

Even if you do not have a computer, you can print images shot using your camera by connecting the camera directly to a PictBridge compliant printer.

“PictBridge” is based on the CIPA standard. (CIPA: Camera & Imaging Products Association)



Note

- You cannot print RAW data files.

Stage 1: Setting the camera

Note

- It is recommended to use the AC Adaptor/charger (not supplied) to prevent the power from turning off partway through printing.

1 MENU button →  **2** → [USB connection] → [PTP]

2 Turn the camera off and insert the memory card that the images have been recorded on.

Stage 2: Connecting the camera to the printer

1 Connect the camera to the printer.

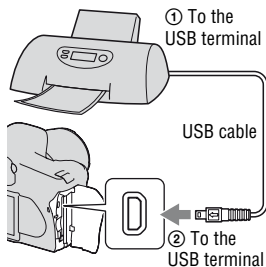

2 Turn on your camera and the printer.

The screen used for selecting images you want to print appears.

Stage 3: Printing

1 Select the image to print with ◀/▶ on the controller, then press the center of the controller.

- To cancel, press the center again.

2 Repeat step 1 if you want to print other images.

3 Press the MENU button and set up each item.

- For details on setting items, see “PictBridge menu.”

4 Select [Print] → [OK] in the menu, then press the center of the controller.

The image is printed.

- After the screen indicating that the print is completed appears, press the center of the controller.

To cancel the print

During printing, pressing the center of the controller cancels the print. Remove the USB cable or turn off the camera. When you want to print again, follow the procedure (Stages 1 to 3) above.

PictBridge menu

Page 1

Print

Prints the selected images. For details, see “Stage 3: Printing.”

Set print q'ty

You can specify the number of prints, up to 20. The same number of prints is specified on all the selected images.

Paper size

Auto	Printer setup
9×13cm/3.5"×5"	89×127 mm
Hagaki	100×147 mm
10×15cm	10×15 cm
4"×6"	101.6×152.4 mm
A6/4.1"×5.8"	105×148.5 mm
13×18cm/5"×7"	127×178 mm
Letter	216×279.4 mm
A4/8.3"×11.7"	210×297 mm
A3/11.7"×16.5"	297×420 mm

Layout

Auto	Printer setup
1-up/Borderless	Borderless, 1 image/sheet
1-up	1 image/sheet
2-up	2 images/sheet
3-up	3 images/sheet
4-up	4 images/sheet
8-up	8 images/sheet
Index	Prints all the selected images as an index print. Printing layout follows the printer setup.

Date imprint

Day and time	Attaches the date and time.
Date	Attaches the date.
Off	Does not attach the date.

Page 2

Unmark all

After the message appears, select [OK], then press the center of the controller. The DPOF mark on each image is cleared. When you cancel your specification without printing images, select this item.

Print all

Prints all the images in a memory card. After the message appears, select [OK], then press the center of the controller.

Specifications

Camera

[System]

Camera Type Digital Single Lens Reflex Camera with built-in flash and interchangeable lenses

Lens All of α Lens

[Image sensor]

Total pixel number of camera
Approx. 10 800 000 pixels

Effective pixel number of camera
Approx. 10 200 000 pixels

Image format
23.6×15.8 mm (APS-C format) Interlace scan
Primary Color

ISO sensitivity (Recommended exposure index)
AUTO, 100 to 3200

[Super SteadyShot]

System Image sensor-Shift mechanism

Super SteadyShot Compensation capability
Approximately 2.5 to 3.5 EV decrease in shutter speed (varies according to shooting conditions and lens used)

[Anti-Dust]

System Charge protection coating on Low-Pass Filter and image sensor-Shift mechanism

[Viewfinder]

Type Fixed eye-level system with pentamirror

Focusing Screen
Spherical Acute Matte

Field of View
0.95

Magnification
0.83 × with 50 mm lens at infinity, -1 m^{-1}

Eye Relief
Approximately 17.6 mm from the eyepiece, 13.5 mm from the eyepiece frame at -1 diopter (-1 m^{-1})

Diopter Adjustment
 -2.5 to $+1.0 \text{ m}^{-1}$

[Auto Focus System]

System TTL phase-detection system, CCD line sensors (9 points, 8 lines with center cross-hair sensor)

Sensitivity Range
0 to 18 EV (at ISO 100 equivalent)

AF illuminator
Approx. 1 to 5 m (3.3 to 16 feet)

[Exposure]

Metering Cell
40-segment honeycomb-pattern SPC

Metering Range
1 to 20 EV (3 to 20 EV with Spot metering), (at ISO 100 with F1.4 lens)

Exposure compensation
 ± 2.0 EV (1/3 EV step)

[Shutter]

Type	Electronically-controlled, vertical-traverse, focal-plane type
Speed range	1/4000 second to 30 seconds, bulb, (1/3 EV step)
Flash sync speed	1/160 second

[Built-In-Flash]

Flash G.No.	GN 12 (in meters at ISO 100)
Recycling time	Approx. 4 seconds
Flash coverage	Covering 18 mm lens (focal length that the lens indicates)
Flash compensation	±2.0 EV (1/3 EV step)

[Recording media]

CompactFlash card (Type I, II), Microdrive, "Memory Stick Duo" (With a Memory Stick Duo Adaptor for CompactFlash slot)

[LCD monitor]

LCD panel	6.7 cm (2.7 type) TFT drive
Total number of dots	230 400 (960 × 240) dots

[Power, general]

Used battery pack	Rechargeable battery pack NP-FM500H
-------------------	-------------------------------------

[Others]

PictBridge	Compatible
Exif Print	Compatible
PRINT Image Matching III	Compatible
Dimensions	Approx. 130.8 × 98.5 × 71.3 mm (5 1/4 × 4 × 2 7/8 inches) (W/H/D, excluding protrusions)
Mass	Approx. 532 g (1 lb 2.8 oz) (without batteries, memory card and body accessories)
Operating temperature	0 to 40°C (32 to 104°F) (When using the Microdrive: 5 to 40°C (41 to 104°F))
Exif	Exif Ver.2.21
USB communication	Hi-Speed USB (USB 2.0 compliant)

BC-VM10 Battery charger

Input rating	100 V – 240 V AC, 50/60 Hz
Output rating	8.4 V DC, 750 mA
Operating temperature range	0 to 40°C (32 to 104°F)
Storage temperature range	-20 to +60°C (-4 to +140°F)
Maximum dimensions	Approx. 70 × 25 × 95 mm (2 7/8 × 1 × 3 3/4 inches) (W/H/D)
Mass	Approx. 90 g (3.2 oz)

Rechargeable battery pack NP-FM500H

Used battery

Lithium-ion battery

Maximum voltage

DC 8.4 V

Nominal voltage

DC 7.2 V

Maximum charge current

2.0 A

Maximum charge voltage

DC 8.4 V

Capacity 11.8 Wh (1 650 mAh)

Maximum dimensions

Approx. 38.2 × 20.5 × 55.6
mm (1 9/16 × 13/16 × 2 1/4
inches) (W/H/D)

Mass Approx. 78 g (2.8 oz)

Design and specifications are subject to change without notice.

On focal length

The picture angle of this camera is narrower than that of a 35 mm-format film camera. You can find the approximate equivalent of the focal length of a 35 mm-format film camera, and shoot with the same picture angle, by increasing the focal length of your lens by half. For example, by using a 50 mm lens, you can get the approximate equivalent of a 75 mm lens of a 35 mm-format film camera.

On image data compatibility

- This camera conforms with DCF (Design rule for Camera File system) universal standard established by JEITA (Japan

Electronics and Information Technology Industries Association).

- Playback of images recorded with your camera on other equipment and playback of images recorded or edited with other equipment on your camera are not guaranteed.

Trademarks

- **α** is a trademark of Sony Corporation.
- “Memory Stick,” , “Memory Stick PRO,” **MEMORY STICK PRO**, “Memory Stick Duo,” **MEMORY STICK DUO**, “Memory Stick PRO Duo,” **MEMORY STICK PRO DUO**, “Memory Stick PRO-HG Duo,” **MEMORY STICK PRO-HG DUO**, “Memory Stick Micro,” “MagicGate,” and **MAGICGATE** are trademarks of Sony Corporation.
- “InfoLITHIUM” is a trademark of Sony Corporation.
- Microsoft, Windows, and Windows Vista are either registered trademarks or trademarks of Microsoft Corporation in the United States and/or other countries.
- Macintosh, Mac OS, iMac, iBook, PowerBook, Power Mac, and eMac are trademarks or registered trademarks of Apple Inc.
- Intel, Intel Core, MMX, and Pentium are trademarks or registered trademarks of Intel Corporation.
- CompactFlash is a trademark of SanDisk Corporation.

- Microdrive is a registered trademark of Hitachi Global Storage Technologies in the United States and/or other countries.
- Adobe is a registered trademark or a trademark of Adobe Systems Incorporated in the United States and/or other countries.
- D-Range Optimizer Advanced uses technology provided by  Apical Limited.
- In addition, system and product names used in this manual are, in general, trademarks or registered trademarks of their respective developers or manufacturers. However, the TM or ® marks are not used in all cases in this manual.

Troubleshooting

If you experience trouble with your camera, try the following solutions. Check the items on pages 143 to 151. Consult your Sony dealer or local authorized Sony service facility.

❶ Check the following items.

❷ Remove the battery pack, and insert the battery pack again after about one minute, and turn on the power.

❸ Reset the settings (page 116).

❹ Consult your Sony dealer or local authorized Sony service facility.

Battery pack and power

The battery pack cannot be installed.

- As you insert the battery pack, use the tip of the battery pack to push the lock lever (page 16).
- Check the model number of the battery pack.

The battery remaining indicator is incorrect, or sufficient battery remaining indicator is displayed but the power runs out too quickly.

- This phenomenon occurs when you use the camera in an extremely hot or cold location (page 154).
- The displayed battery remaining differs from the current one. Fully discharge and then charge the battery pack to correct the display.
- The battery pack is discharged. Install a charged battery pack (page 16).
- The battery pack is dead (page 18). Replace it with new one.

Cannot turn on the camera.

- Install the battery pack correctly (page 16).
- The battery pack is discharged. Install a charged battery pack (page 16).
- The battery pack is dead (page 18). Replace it with new one.

The power turns off suddenly.

- If you do not operate the camera for given period of time, the camera turns to power saving mode and nearly shuts down. To cancel the power save, operate the camera, such as pressing the shutter button halfway down (page 48).

Shooting images

Nothing is displayed on the LCD monitor when the power is turned on.

- In the default setting, the LCD monitor will turn off if no operation is registered for more than five seconds to minimize the battery consumption. You can change the time that the LCD monitor is turned off (page 113).
- The LCD monitor is set to off. Press the DISP button to turn the LCD monitor on (page 39).

The image is not clear in the viewfinder.

- Adjust the diopter scale properly using the diopter-adjustment dial (page 26).

The image has not been recorded.

- A memory card is not inserted.

The shutter does not release.

- Check the free capacity of the memory card (page 29). If it is full, do one of the following:
 - Delete unnecessary images (page 102).
 - Change the memory card.
- You cannot record images while charging the built-in flash (page 72).
- The shutter cannot be released when the subject is out of focus (page 67).
- The lens is not attached properly. Attach the lens properly (page 19).
- When an astronomical telescope, etc., is attached to the camera, set the recording mode to M and do your shooting.
- You try to shoot a subject that may require special focusing (page 68). Use the focus-lock or manual focus function (pages 69, 71).

Recording takes a long time.

- The noise reduction function is turned on (page 110). This is not a malfunction.

- You are shooting in RAW mode (page 106). Since the RAW data file is large, the RAW mode shooting may take time.

The image is out of focus.

- The subject is too close. Check the minimum focal distance of the lens.
- You are shooting in manual focus mode, set the focus mode lever to AF (autofocus) (page 67).

Eye-Start AF does not work.

- Set [Eye-Start AF] to [On] (page 69).
- Press the shutter button halfway down.

The flash does not work.

- The flash mode is set to [Autoflash]. If you want to make sure the flash fires without fail, set the flash mode to [Fill-flash] (page 74).

Fuzzy specks appear in images shot using the flash.

- Dust in the air reflected the flash light and appeared in the image. This is not a malfunction.

The flash takes too long to recharge.

- The flash has been fired in succession in a short period. When the flash has been fired in succession, the recharging process may take longer than usual to avoid overheating of the camera.

A picture taken with the flash is too dark.

- If the subject is beyond the flash range (the distance that the flash can reach), the pictures will be dark because the flash light does not reach the subject. If the ISO is changed, the flash range also changes with it (page 73).

The date and time are recorded incorrectly.

- Set the correct date and time (pages 25, 113).

The aperture value and/or shutter speed flash when you press the shutter button halfway down.

- Since the subject is too bright or too dark, it is beyond the available range of the camera. Adjust the setting again.

The image is whitish (Flare).**Blurring of light appears on the image (Ghosting).**

- The picture was taken under a strong light source, and excessive light has entered the lens. Attach a lens hood.

The corners of the picture are too dark.

- If any filter or hood is used, take it off and try shooting again. Depending on the thickness of the filter and improper attachment of the hood, the filter or the hood may partially appear in the image. The optical properties of some lenses may cause the periphery of the image to appear too dark (insufficient light).

The eyes of the subject come out red.

- Activate the red eye reduction function (page 73).
- Get close to the subject, and shoot the subject within the flash range using the flash (page 73).

Dots appear and remain on the LCD monitor.

- This is not a malfunction. These dots are not recorded (page 8).

The image is blurred.

- The picture was taken in a dark location without the flash, resulting in camera shake. The use of the Super SteadyShot function or a tripod is recommended. The flash can be used in this situation (page 46).

The EV scale ◀ ▶ is flashing in the viewfinder.

- The subject is too bright or too dark for the metering range of the camera.

Viewing images

Your camera cannot play back images.

- The folder/file name has been changed on your computer (page 125).
- When an image file has been processed by a computer or when the image file was recorded using a model other than that of your camera, playback on your camera is not guaranteed.
- The camera is in USB mode. Delete the USB connection (page 124).

The image does not appear on the TV screen.

- Check [Video output] to see if the video output signal of your camera is set to the color system of your TV (page 105).
- Check whether the connection is correct (page 104).

Deleting/Editing images

Your camera cannot delete an image.

- Cancel the protection (page 101).

You have deleted an image by mistake.

- Once you have deleted an image, you cannot restore it. We recommend that you protect images that you do not want to delete (page 101).

You cannot mark a DPOF mark.

- You cannot mark DPOF marks on RAW data files.

Computers

You do not know if the OS of your computer is compatible with the camera.

- Check “Recommended computer environment” (pages 119, 127).

Your computer does not recognize your camera.

- Check that the camera is turned on.
- When the battery level is low, install the charged battery pack (page 16), or use the AC Adaptor/charger (not supplied).
- Use the USB cable (supplied) (page 120).
- Disconnect the USB cable, and connect it again firmly.
- Set [USB connection] to [Mass Storage] (page 120).
- Disconnect all equipment other than the camera, the keyboard and the mouse from the USB jacks of your computer.
- Connect the camera directly to your computer without passing through a USB hub or other device (page 119).

You cannot copy images.

- Make the USB connection by properly connecting the camera with your computer (page 120).
- Follow the designated copy procedure for your OS (page 121).
- When you shoot images with a memory card formatted by a computer, you may not be able to copy the images to a computer. Shoot using a memory card formatted by your camera (page 109).

The image cannot be played back on a computer.

- If you are using “Picture Motion Browser,” refer to the “Picture Motion Browser Guide.”
- Consult the computer or software manufacturer.

After making a USB connection, “Picture Motion Browser” does not start automatically.

- Make the USB connection after the computer is turned on (page 120).

You do not know how to operate the software (supplied).

- See the help or the guide of each software.

Memory card

Cannot insert a memory card.

- Insertion direction of the memory card is wrong. Insert it in the correct direction (page 21).

Cannot record on a memory card.

- The memory card is full. Delete unnecessary images (page 102).
- An unusable memory card is inserted (page 21).
- You are using the memory card with the write-protect switch, and the switch is set to the LOCK position. Set the switch to the recording position.

The Microdrive is heated.

- You are using the Microdrive for a long time. This is not a malfunction.

You have formatted a memory card by mistake.

- All the data on the memory card is deleted by formatting. You cannot restore it.

“Memory Stick PRO Duo” is not recognized by a computer with a “Memory Stick” slot.

- If “Memory Stick PRO Duo” is not supported on your computer’s “Memory Stick” slot, connect the camera to the computer (page 120). The computer recognizes the “Memory Stick PRO Duo.”

Printing

Also see “PictBridge compliant printer” (as follows) in conjunction with the following items.

The color of the image is strange.

- When you print the images recorded in Adobe RGB mode using sRGB printers that are not compatible with Adobe RGB (DCF2.0/Exif2.21), the images are printed at a lower intensity level (page 88).

Images are printed with both edges cut off.

- Depending on your printer, the left, right, top, and bottom edges of the image may be cut off. Especially when you print an image shot with the aspect ratio set to [16:9], the lateral end of the image may be cut off.
- When printing images using your own printer, cancel the trimming or borderless settings. Consult the printer manufacturer as to whether the printer provides these functions or not.
- When having images printed at a digital print shop, ask the shop whether they can print the images without cutting off both edges.

Cannot print images with the date.

- Using “Picture Motion Browser,” you can print images with date (page 130).
- This camera does not have a feature for superimposing dates on images. However, because the images shot with the camera include information on the recording date, you can print images with the date superimposed if the printer or the software can recognize Exif information. For compatibility with Exif information, consult the manufacturer of the printer or the software.
- When you print images at a shop, images can be printed with the date if you ask them to do so.

PictBridge compliant printer

For details, refer to the operating instructions supplied with the printer or consult with the manufacturer of the printer.

A connection cannot be established.

- The camera cannot be connected directly to a printer that is not compliant with the PictBridge standard. Consult the printer manufacturer as to whether the printer is compliant with PictBridge or not.
- Set [USB connection] to [PTP] (page 135).
- Disconnect and connect the USB cable again. If an error message is indicated on the printer, refer to the operating instructions supplied with the printer.

Cannot print images.

- Check that the camera and the printer are properly connected using the USB cable.
- RAW data files cannot be printed.
- Images shot using cameras other than this camera or images modified with a computer may not be printed.

“---- -- --” is printed on the date-inserted part of the image.

- Images that do not have the recording data cannot be printed with the date inserted. Set [Date imprint] to [Off] and print the image again (page 138).

Cannot print the image at the size selected.

- Disconnect the USB cable and reconnect it whenever you change the paper size after the printer has been connected to the camera.
- The print setting of the camera differs from that of the printer. Change the setting of either the camera (page 136) or the printer.

Cannot operate the camera after canceling printing.

- Wait for a while as the printer is carrying out the cancellation. It may take some time depending on the printer.

The lens gets fogged.

- Moisture condensation has occurred. Turn off the camera and leave it for about an hour before using it (page 154).

The message “Set date and time?” appears when you turn on the camera.

- The camera has been left unused for sometime with a low battery or no battery pack. Charge the battery pack and set the date again (page 25). If the date setting is lost every time the battery pack is charged, consult your Sony dealer or local authorized Sony service facility.

The number of recordable images does not decrease or decreases two at a time.

- This is because the compression rate and the image size after compression change depending on the image when you shoot a JPEG image (page 106).

The setting is reset without the resetting operation.

- The battery pack was removed when the POWER switch was set to ON. When removing the battery pack, make sure the POWER switch is set to OFF and the access lamp is not illuminated (page 25).

The camera does not work properly.

- Turn off the camera. Remove the battery pack and insert it again. If an AC Adaptor/charger (not supplied) is used, disconnect the power cord. If the camera is hot, allow it to cool down before trying this corrective procedure. If the camera does not work after doing these solutions, consult your Sony dealer or local authorized Sony service facility.

The five bars of the Super SteadyShot scale flash.

- The Super SteadyShot function does not work. You can continue to shoot but the Super SteadyShot function will not work. Turn the camera off and on. If the Super SteadyShot scale continues to flash, consult your Sony dealer or local authorized Sony service facility.

“--E-” is indicated on the lower-right corner of the LCD monitor.

- Remove the memory card, and insert it again. If this procedure does not turn off the indication, format the memory card.

Warning messages

If the following messages appear, follow the instructions.

For “InfoLITHIUM” battery only

- An incompatible battery pack is being used.

Set date and time?

- Set the date and time. If you have not used the camera for a long time, charge the internal rechargeable battery (pages 25, 154).

Power insufficient

- You tried to perform [Cleaning mode] when the battery level is insufficient. Charge the battery pack or use the AC Adaptor/charger (not supplied).

No card

- Insert a memory card.

Unable to use card. Format?

- The memory card was formatted on a computer and the file format was modified, or the memory card was formatted on another device. Select [OK], then format the memory card. You can use the memory card again, however, all previous data in the memory card is erased. It may take a some time to complete the format.

If the message still appears, change the memory card.

Card error

- An incompatible memory card is inserted or the format was failed.

Reinsert the card.

- The inserted memory card cannot be used in your camera.
- The memory card is damaged.
- The terminal section of the memory card is dirty.

Processing...

- When Long exposure noise reduction will be done for the same amount of time that the shutter was open. You cannot do any further shooting during this reduction.

Unable to display.

- Images recorded with other cameras or images modified with a computer may not be able to be displayed.

No lens attached. Shutter is locked.

- The lens is not attached properly, or the lens is not attached. When attaching the camera to an astronomical telescope or something similar, set the recording mode to M.

No images

- There is no image in the memory card.

Image protected

- You tried to delete protected images.

Unable to print.

- You tried to mark RAW images with a DPOF mark.

Initializing USB connection...

- A USB connection has been established. Do not disconnect the USB cable.

Check the connected device.

- A PictBridge connection cannot be established. Disconnect the USB cable and connect it again.

Camera overheating. Allow it to cool.

- The camera has become hot because you have been shooting continuously.
Turn the power off. Cool the camera and wait until the camera is ready to shoot again.

**Camera error
System error**

- Turn the power off, remove the battery pack, then re-insert it. If the message appears frequently, consult your Sony dealer or local authorized Sony service facility.

**Unable to magnify.
Unable to rotate image.**

- Images recorded with other cameras may not be enlarged or rotated.

No images changed

- You attempted to protect images or specified DPOF without changing the specification of those images.

Cannot create more folders.

- The folder with a name beginning with “999” exists on the memory card. You cannot create any folders if this is the case.

Printing canceled

- The print job was canceled. Disconnect the USB cable or turn the camera off.

Unable to mark.

- You attempted to mark RAW images on the PictBridge screen.

Printer error

- Check the printer.
- Check if the image you want to print is corrupted.

Printer busy

- Check the printer.

Precautions

Do not use/store the camera in the following places

- In an extremely hot, dry or humid place
In places such as in a car parked in the sun, the camera body may become deformed and this may cause a malfunction.
- Under direct sunlight or near a heater
The camera body may become discolored or deformed, and this may cause a malfunction.
- In a location subject to rocking vibration
- Near strong magnetic place
- In sandy or dusty places
Be careful not to let sand or dust get into the camera. This may cause the camera to malfunction, and in some cases this malfunction cannot be repaired.

On carrying

- Be sure to attach the lens cap or body cap when not using the camera. When attaching the body cap, remove all the dust from the cap before placing it on the camera.

On operating temperatures

Your camera is designed for use under the temperatures between 0 and 40°C (32 and 104°F) (When using a Microdrive: 5 and 40°C (41 and 104°F)). Shooting in extremely cold

or hot places that exceed this range is not recommended.

On moisture condensation

If the camera is brought directly from a cold to a warm location, moisture may condense inside or outside the camera. This moisture condensation may cause a malfunction of the camera.

How to prevent moisture condensation

When bringing the camera from a cold place to a warm place, seal the camera in a plastic bag and allow it to adapt to conditions at the new location over about an hour.

If moisture condensation occurs

Turn off the camera and wait about an hour for the moisture to evaporate. Note that if you attempt to shoot with moisture remaining inside the lens, you will be unable to record clear images.

On the internal rechargeable battery

This camera has an internal rechargeable battery for maintaining the date and time and other settings regardless of whether the power is on or off.

This rechargeable battery is continually charged as long as you are using the camera. However, if you use the camera for only short periods, it discharges gradually, and if you do not use the camera at all for about 8 months it becomes completely

discharged. In this case, be sure to charge this rechargeable battery before using the camera. However, even if this rechargeable battery is not charged, you can still use the camera as long as you do not record the date and time. If the camera resets the settings to the defaults each time you charge the internal rechargeable battery, the battery may be dead. Consult your Sony dealer or local authorized Sony service facility.

Charging method of the internal rechargeable battery

Insert a charged battery pack in the camera, or connect the camera to a wall outlet (wall socket) using the AC Adaptor/charger (not supplied), and leave the camera for 24 hours or more with the power off.

Notes on recording/playback

- Before you record one-time events, make a trial recording to make sure that the camera is working correctly.
- This camera is neither dust-proof, nor splash-proof, nor water-proof.
- Do not look at the sun or a strong light through a removed lens or the viewfinder. This may cause irrecoverable damage to your eyes. Or it may cause a malfunction of your camera.
- Do not use the camera near a location that generates strong radio waves or emits radiation. The camera may not be able to record or play back properly.

- Using the camera in sandy or dusty locations may cause malfunctions.
- If moisture condensation occurs, remove it before using the camera (page 154).
- Do not shake or strike the camera. In addition to malfunctions and an inability to record images, this may render the memory card unusable, or cause image data breakdown, damage or loss.
- Clean the flash surface before use. The heat of flash emission may cause dirt on the flash surface to become discolored or to stick to the flash surface, resulting in insufficient light emission.
- Keep the camera, supplied accessories, etc., out of the reach of children. The battery pack, the accessory shoe cap, etc., may be swallowed. If such a problem occurs, consult a doctor immediately.

Index

Numerics

40-segment honeycomb pattern
metering.....80

A

Adobe RGB87
AE lock.....76
AEL button112
AF area70
AF illuminator73
Ambient bracket91
Amount of exposure56
Anti-dust function.....32
Aperture56, 59
Aperture priority59
Aspect ratio.....106
Audio signals113
Auto off w/ VF115
Auto review114
Autoflash72, 74
Autofocus67
Autofocus mode.....69

B

Battery pack.....16
Bracket.....90
BULB shooting.....65

C

Center weighted.....80

CF card.....21
Charging battery pack.....14
Cleaning mode32
Color filter84
Color temperature84
Compression ratio106
Continuous AF.....69
Continuous bracket90
Continuous shooting89
Contrast.....87
Correct exposure60, 62
Creative Style.....87
Ctrl dial setup.....58, 112
Custom white balance.....85

D

Date imprint134
Date/Time setup.....25, 113
Delete102
Depth of field56
Diopter-adjustment26
DPOF setup.....133
D-Range Optimizer.....87
Drive button41
Drive mode89

E

Enlarged screen.....94
EV scale64, 77, 91
Exposure56

Exposure compensation	78	Image size	106
Exposure lock	76	Index print	134
Exposure mode	56	Index screen	96
Eyecup	27	Info.disp.time	114
Eyepiece cover	27	ISO sensitivity	82
Eyepiece sensors	28		
Eye-Start AF	69		

F

File number	108
Flash compensation	79
Flash control	79
Flash mode	72, 74
Flash Off	48, 74
Fn button	41
Focal length	141
Focus	67
Focus indicator	68
Focus mode	69
Focus-lock	69
Folder name	108
Format	109

H

High ISO NR	110
High-key portion	100
High-speed sync	40
Histogram	93, 99, 100

I

Image Data Converter SR	131
Image Data Lightbox SR	132
Image quality	106

J

JPEG	106
------------	-----

L

Landscape	51
LCD brightness	114
LCD monitor	37, 39, 98
Lens	19
Long exp.NR	110
Low-key portion	100

M

Macro	52
Manual exposure	63
Manual focus	71
Manual shift	64
“Memory Stick Duo”	21
Menu	43
Metering mode	80
Microdrive	21
Moisture condensation	154
Multi segment	80

N

New folder	109
Night portrait	55
Night view	55

Noise reduction.....110
Number of recordable images
.....29, 30

P

PictBridge135
Picture Motion Browser130
PlaybackDisplay93
Portrait50
Power save113
Preset white balance83
Pressing halfway down.....49, 67
Print133, 135
Priority setup111
Program auto57
Program Shift.....58
Protect.....101

R

RAW106, 131
Rear sync.74
Rec mode reset116
Red eye reduc.73
Reducing camera shake45
Reset116
Reset default117
Rotate.....94

S

Saturation.....87
Scene Selection.....50
Self-timer90
Set the clock25

Sharpness 87
Shooting..... 48
Shoulder strap 27
Shutter speed..... 56, 61
Shutter speed priority 61
Single bracket 90
Single-shot AF 69
Slide show..... 97
Slow sync..... 74
Specifications..... 139
Sports action 53
Spot..... 80
Sunset..... 54
Super SteadyShot function 46

U

USB connection 120, 136

V

Video output 105
Viewfinder 26, 40
Viewing image..... 93, 104

W

White balance 83
White balance bracket..... 92
Wireless flash..... 74