

Before your operation

Using the shooting functions

Using the viewing functions

Using the menu

Using your computer

Printing images

Troubleshooting

Others

Index

Digital Single Lens Reflex Camera
User's Guide/
Troubleshooting

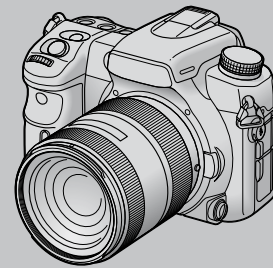

α700

DSLR-A700



HDMI



"Read This First" (separate volume)
 Explains the set-up and basic operations for shooting/
 playback with your camera.

Operating Instructions

Before operating the unit, please read this manual and "Read This First" (separate volume) thoroughly, and retain them for future reference.

Owner's Record

The model and serial numbers are located on the bottom. Record the serial number in the space provided below. Refer to these numbers whenever you call upon your Sony dealer regarding this product.
 Model No. DSLR-A700
 Serial No. _____

Additional information on this product and answers to frequently asked questions can be found at our Customer Support Website.

<http://www.sony.net/>

Printed on 70% or more recycled paper using VOC (Volatile Organic Compound)-free vegetableoil based ink.

Printed in Japan



3216921150

© 2007 Sony Corporation



WARNING

To reduce fire or shock hazard, do not expose the unit to rain or moisture.

For Customers in the U.S.A.

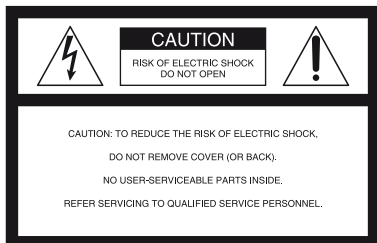

This symbol is intended to alert the user to the presence of uninsulated “dangerous voltage” within the product’s enclosure that may be of sufficient magnitude to constitute a risk of electric shock to persons.



This symbol is intended to alert the user to the presence of important operating and maintenance (servicing) instructions in the literature accompanying the appliance.

IMPORTANT SAFEGUARDS

For your protection, please read these safety instructions completely before operating the appliance, and keep this manual for future reference.

Carefully observe all warnings, precautions and instructions on the appliance, or the one described in the operating instructions and adhere to them.

Use

Power Sources

This set should be operated only from the type of power source indicated on the marking label. If you are not sure of the type of electrical power supplied to your home, consult your dealer or local power company. For those sets designed to operate from battery power, or other sources, refer to the operating instructions.

Polarization

This set may be equipped with a polarized ac power cord plug (a plug having one blade wider than the other).

This plug will fit into the power outlet only one way. This is a safety feature. If you are unable to insert the plug fully into the outlet, try reversing the plug. If the plug should still fail to fit, contact your electrician to have a suitable outlet installed. Do not defeat the safety purpose of the polarized plug by forcing it in.

Overloading

Do not overload wall outlets, extension cords or convenience receptacles beyond their capacity, since this can result in fire or electric shock.

Object and Liquid Entry

Never push objects of any kind into the set through openings as they may touch dangerous voltage points or short out parts that could result in a fire or electric shock. Never spill liquid of any kind on the set.

Attachments

Do not use attachments not recommended by the manufacturer, as they may cause hazards.

Cleaning

Unplug the set from the wall outlet before cleaning or polishing it. Do not use liquid cleaners or aerosol cleaners. Use a cloth lightly dampened with water for cleaning the exterior of the set.

Installation

Water and Moisture

Do not use power-line operated sets near water – for example, near a bathtub, washbowl, kitchen sink, or laundry tub, in a wet basement, or near a swimming pool, etc.

Power-Cord Protection

Route the power cord so that it is not likely to be walked on or pinched by items placed upon or against them, paying particular attention to the plugs, receptacles, and the point where the cord exits from the appliance.

Accessories

Do not place the set on an unstable cart, stand, tripod, bracket, or table. The set may fall, causing serious injury to a child or an adult, and serious damage to the set. Use only a cart, stand, tripod, bracket, or table recommended by the manufacturer.

Ventilation

The slots and openings in the cabinet are provided for necessary ventilation. To ensure reliable operation of the set, and to protect it from overheating, these slots and openings must never be blocked or covered.

- Never cover the slots and openings with a cloth or other materials.
- Never block the slots and openings by placing the set on a bed, sofa, rug, or other similar surface.
- Never place the set in a confined space, such as a bookcase, or built-in cabinet, unless proper ventilation is provided.
- Do not place the set near or over a radiator or heat register, or where it is exposed to direct sunlight.

Lightning

For added protection for this set during a lightning storm, or when it is left unattended and unused for long periods of time, unplug it from the wall outlet and disconnect the antenna or cable system. This will prevent damage to the set due to lightning and power-line surges.

Service

Damage Requiring Service

Unplug the set from the wall outlet and refer servicing to qualified service personnel under the following conditions:

- When the power cord or plug is damaged or frayed.
- If liquid has been spilled or objects have fallen into the set.
- If the set has been exposed to rain or water.
- If the set has been subject to excessive shock by being dropped, or the cabinet has been damaged.
- If the set does not operate normally when following the operating instructions. Adjust only those controls that are specified in the operating instructions. Improper adjustment of other controls may result in damage and will often require extensive work by a qualified technician to restore the set to normal operation.
- When the set exhibits a distinct change in performance – this indicates a need for service.

Servicing

Do not attempt to service the set yourself as opening or removing covers may expose you to dangerous voltage or other hazards.

Refer all servicing to qualified service personnel.

Replacement parts

When replacement parts are required, be sure the service technician has used replacement parts specified by the manufacturer that have the same characteristics as the original parts.

Unauthorized substitutions may result in fire, electric shock, or other hazards.

Safety Check

Upon completion of any service or repairs to the set, ask the service technician to perform routine safety checks (as specified by the manufacturer) to determine that the set is in safe operating condition.

Read this first

CAUTION

Replace the battery with the specified type only. Otherwise, fire or injury may result. Do not expose the batteries to excessive heat such as sunshine, fire or the like.

For Customers in the U.S.A. and Canada

RECYCLING LITHIUM-ION BATTERIES

Lithium-Ion batteries are recyclable.

You can help preserve our environment by returning your used rechargeable batteries to the collection and recycling location nearest you.



For more information regarding recycling of rechargeable batteries, call toll free 1-800-822-8837, or visit <http://www.rbrbc.org/>

Caution: Do not handle damaged or leaking Lithium-Ion batteries.

Battery pack

This device complies with Part 15 of the FCC Rules. Operation is subject to the following two conditions:

(1) This device may not cause harmful interference, and (2) this device must accept any interference received, including interference that may cause undesired operation.

This Class B digital apparatus complies with Canadian ICES-003.

For Customers in the U.S.A.

If you have any questions about this product, you may call:

Sony Customer Information Services Center
1-800-222-SONY (7669)

The number below is for the FCC related matters only.

Regulatory Information

Declaration of Conformity

Trade Name: SONY
Model No.: DSLR-A700
Responsible Party: Sony Electronics Inc.
Address: 16530 Via Esprillo,
San Diego, CA 92127 U.S.A.
Telephone No.: 858-942-2230

This device complies with Part 15 of the FCC Rules. Operation is subject to the following two conditions: (1) This device may not cause harmful interference, and (2) this device must accept any interference received, including interference that may cause undesired operation.

CAUTION

You are cautioned that any changes or modifications not expressly approved in this manual could void your authority to operate this equipment.

Note:

This equipment has been tested and found to comply with the limits for a Class B digital device, pursuant to Part 15 of the FCC Rules.

These limits are designed to provide reasonable protection against harmful interference in a residential installation. This equipment generates, uses, and can radiate radio frequency energy and, if not installed and used in accordance with the instructions, may cause harmful interference to radio communications. However, there is no guarantee that interference will not occur in a particular installation. If this equipment does cause harmful interference to radio or television reception, which can be determined by turning the equipment off and on, the user is encouraged to try to correct the interference by one or more of the following measures:

- Reorient or relocate the receiving antenna.
- Increase the separation between the equipment and receiver.
- Connect the equipment into an outlet on a circuit different from that to which the receiver is connected.
- Consult the dealer or an experienced radio/TV technician for help.

The supplied interface cable must be used with the equipment in order to comply with the limits for a digital device pursuant to Subpart B of Part 15 of FCC Rules.

For the State of California, USA only

Perchlorate Material - special handling may apply, See

www.dtsc.ca.gov/hazardouswaste/perchlorate

Perchlorate Material: Lithium battery contains perchlorate.

For Customers in Europe

This product has been tested and found compliant with the limits set out in the EMC Directive for using connection cables shorter than 3 meters (9.8 feet).

Attention

The electromagnetic fields at the specific frequencies may influence the picture and sound of this unit.

Notice

If static electricity or electromagnetism causes data transfer to discontinue midway (fail), restart the application or disconnect and connect the communication cable (USB, etc.) again.

Disposal of Old Electrical & Electronic Equipment (Applicable in the European Union and other European countries with separate collection systems)





This symbol on the product or on its packaging indicates that this product shall not be treated as household waste. Instead it shall be handed over to the applicable collection point for the recycling of electrical and electronic equipment. By ensuring this product is disposed of correctly, you

will help prevent potential negative consequences for the environment and human health, which could otherwise be caused by inappropriate waste handling of this product. The recycling of materials will help to conserve natural resources. For more detailed information about recycling of this product, please contact your local Civic Office, your household waste disposal service or the shop where you purchased the product.

Applicable Accessories: Remote Commander

Notice for customers in the United Kingdom

A moulded plug complying with BS 1363 is fitted to this equipment for your safety and convenience.

Should the fuse in the plug supplied need to be replaced, a fuse of the same rating as the supplied one and approved by ASTA or BSI to BS 1362, (i.e., marked with an  or  mark) must be used.

If the plug supplied with this equipment has a detachable fuse cover, be sure to attach the fuse cover after you change the fuse. Never use the plug without the fuse cover. If you should lose the fuse cover, please contact your nearest Sony service station.

Notice for the customers in the countries applying EU Directives

The manufacturer of this product is Sony Corporation, 1-7-1 Konan Minato-ku Tokyo, 108-0075 Japan. The Authorized Representative for EMC and product safety is Sony Deutschland GmbH, Hedelfinger Strasse 61, 70327 Stuttgart, Germany. For any service or guarantee matters please refer to the addresses given in separate service or guarantee documents.

Notes on using your camera

Notes on types of “Memory Stick” that can be used (not supplied)

You can use a “Memory Stick Duo” with your camera. A “Memory Stick” cannot be used with your camera.



“Memory Stick Duo”



“Memory Stick”

- For details on “Memory Stick Duo”, see page 161.

Notes on the “InfoLITHIUM” battery pack

- Charge the NP-FM500H (supplied) battery pack before using the camera for the first time. (→ *step 1* in “*Read This First*”)
- The battery pack can be charged even if it is not completely discharged. Also, even if the battery pack is not fully charged, you can use the partially charged capacity of the battery pack as is.
- If you do not intend to use the battery pack for a long time, use up the existing charge and remove it from your camera, then store it in a cool, dry place. This is to maintain the battery pack functions (page 163).
- For details on the battery pack, see page 163.

No compensation for contents of the recording

The contents of the recording cannot be compensated for if recording or playback is not possible due to a malfunction of your camera or a memory card, etc.

Back up recommendation

To avoid the potential risk of data loss, always copy (back up) data to other medium.

Notes on recording/playback

- Before you record one-time events, make a trial recording to make sure that the camera is working correctly.
- This camera is designed to be dust- and moisture-resistant but not to be waterproof and splash-proof. When using the camera in the rain, be careful not to get the camera and lens wet. Clean the camera after use if the camera becomes dirty. With water, sand, dust, salt, etc., left on the camera, the camera may cause a malfunction. Read also “Precautions” (page 168).
- Do not look at the sun or a strong light through a removed lens or the viewfinder. This may cause irrecoverable damage to your eyes. Or it may cause a malfunction of your camera.
- Do not use the camera near a location that generates strong radio waves or emits radiation. The camera may not be able to record or play back properly.
- Using the camera in sandy or dusty locations may cause malfunctions.
- If moisture condensation occurs, remove it before using the camera (page 168).
- Do not shake or strike the camera. In addition to malfunctions and an inability to record images, this may render the memory card unusable, or cause image data breakdown, damage or loss.
- Clean the flash surface before use. The heat of flash emission may cause dirt on the flash surface to become discolored or to stick to the flash surface, resulting in insufficient light emission.
- Keep the camera, supplied accessories, etc., out of the reach of children. The battery pack, the accessory shoe cap, etc., may be swallowed. If such a problem occurs, consult a doctor immediately.

Notes on the LCD monitor and lens

- The LCD monitor is manufactured using extremely high-precision technology so over 99.99% of the pixels are operational for effective use. However, there may be some tiny black points and/or bright points (white, red, blue or green in color) that constantly appear on the LCD monitor. These points are normal in the manufacturing process and do not affect the images in any way.

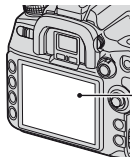

Black, white, red, blue
and green points

- Do not expose the camera to direct sunlight. If sunlight is focused on a nearby object, it may cause a fire. When you must place the camera under direct sunlight, attach the lens cap.
- Images may trail across on the LCD monitor in a cold location. This is not a malfunction. When turning on the camera in a cold location, the LCD monitor may become temporarily dark. When the camera warms up, the monitor will function normally.
- Do not press against the LCD monitor. The monitor may be discolored and that may cause a malfunction.

On focal length

The picture angle of this camera is narrower than that of a 35 mm-format film camera. You can find the approximate equivalent of the focal length of a 35 mm-format film camera, and shoot with the same picture angle, by increasing the focal length of your lens by half.

For example, by using a 50 mm lens, you can get the approximate equivalent of a 75 mm lens of a 35 mm-format film camera.

On image data compatibility

- This camera conforms with DCF (Design rule for Camera File system) universal standard established by JEITA (Japan Electronics and Information Technology Industries Association).
- Playback of images recorded with your camera on other equipment and playback of images recorded or edited with other equipment on your camera are not guaranteed.

Warning on copyright

Television programs, films, videotapes, and other materials may be copyrighted. Unauthorized recording of such materials may be contrary to the provisions of the copyright laws.

The pictures used in this manual

The photographs used as examples of pictures in this manual are reproduced images, and are not actual images shot using this camera.

Table of contents

IMPORTANT SAFEGUARDS	3
Read this first	5
Notes on using your camera	7

Before your operation

Identifying parts	14
Indicators on the monitor	19
Switching the recording information display	23
Number of images	24
The number of images that can be recorded when using the battery pack	28
Basic operation.....	29
How to use the multi-selector	29
How to use the Fn (Function) button	30
How to use the menu.....	32

Using the shooting functions



Using the mode dial.....	34
Scene Selection.....	35
Shooting with program auto – P	36
Shooting with aperture priority mode – A.....	37
Shooting with shutter speed priority mode – S.....	39
Shooting with manual exposure mode – M.....	41
Exposure	45
Adjusting the exposure	45
Locking the exposure (AE lock)	46
Selecting the metering mode	48
Focus.....	49
Setting the AF area.....	49
Selecting the focus mode.....	52
Switching the AF/MF easily	53
Using AF illuminator	54
Drive mode	55
Shooting continuously	56
Using the self-timer	57
Shooting images with the exposure shifted – Bracket: Cont./Bracket: Single	57
Shooting with the WB bracket	59
Shooting with the DRO advanced bracket.....	59
Shooting with the Remote Commander.....	60







Image processing and color	61
Adjusting the white balance	61
Setting ISO.....	64
Using the D-Range Optimizer	66
Using a Creative Style	67
Flash	73
Selecting the flash mode	73
Using the flash compensation	75
Shooting with Slow Sync (Shooting the dark background with flash)	77
Using the flash sync terminal	77
Other operations	79
Registering your own settings	79
Using the C (Custom) button.....	81

Using the viewing functions

Viewing images	83
Switching the playback screen	83
Switching to the index screen	84
Displaying the histogram.....	85
Enlarging images.....	86
Rotating an image	88
Viewing images on a TV screen	89
Operating with the Remote Commander.....	91

Using the menu

Menu list	92
 Recording menu 1	94
Image size	
Aspect ratio	
Quality	
D-RangeOptimizer	
Creative Style	
Custom button	
Exposure step	
 Recording menu 2	99
Flash mode	
Flash control	
Power ratio	
Flash compens.	
ISO Auto max.	
ISO Auto min.	

	Recording menu 3	101
	AF-A setup	
	AF area	
	Priority setup	
	AF illuminator	
	AF w/ shutter	
	Long exp.NR	
	High ISO NR	
	Recording menu 4	104
	Memory	
	Rec mode reset	
	Custom menu 1.....	105
	Eye-Start AF	
	EyeStart trigr.	
	AF/MF button	
	AF/MF control	
	AF drive speed	
	AF area disp.	
	FocusHoldButton	
	Custom menu 2.....	107
	AEL button	
	Ctrl dial setup	
	Dial exp.comp	
	Ctrl dial lock	
	Button ops.	
	Release w/oCard	
	Release w/oLens	
	Custom menu 3.....	110
	Red eye reduc.	
	Exp.comp.set	
	Bracket order	
	Auto review	
	Auto off w/ VF	
	Rec.info.disp.	
	Img.orientation	
	Custom menu 4.....	113
	Custom reset	

▶ Playback menu 1	114
Delete	
Format	
Protect	
DPOF setup	
Date imprint	
Index print	
PlaybackDisplay	
▶ Playback menu 2	119
Slide show	
Interval	
🔧 Setup menu 1	120
LCD brightness	
Info.disp.time	
Power save	
Video output	
HDMI output	
🗣 Language	
Date/Time setup	
🔧 Setup menu 2	123
Memory card	
File number	
Folder name	
Select folder	
New folder	
USB connection	
MassStrg.card	
🔧 Setup menu 3	125
Menu start	
Delete confirm.	
Audio signals	
Cleaning mode	
Reset default	

Using your computer

Enjoying your computer.....	127
Connecting the camera and your computer	129
Copying images to your computer.....	130
Image file storage destinations and file names	133
Copying images stored on a computer to a memory card and viewing the images.....	134
Using the software (supplied).....	135
Installing the software.....	136
Using the “Picture Motion Browser”.....	137
Using the “Image Data Converter SR”	139
Using the “Image Data Lightbox SR”.....	140
Using the “Remote Camera Control”	142

Printing images

How to print images.....	145
Printing images directly using a PictBridge compliant printer.....	146

Troubleshooting

Troubleshooting.....	149
Warning messages.....	158

Others

On the memory card (not supplied).....	161
On the “InfoLITHIUM” battery pack	163
On the battery charger	164
Optional accessories	165
Precautions	168
Specifications	170
Reset default	172

Index

176

Identifying parts



Camera

* Do not directly touch these parts.

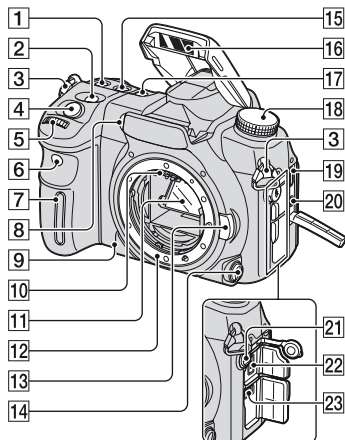
See the pages in parentheses for details of operation.



- 1** ISO button (64)
- 2**  (Exposure) button (45)
- 3** Hooks for shoulder strap (17)
- 4** Shutter button (→ *step 5 in “Read This First”*)
- 5** Front control dial (30, 107)
- 6** Remote sensor (60)
- 7** Grip sensor (105)
- 8** AF illuminator (54, 102)/Self-timer lamp (57)
- 9** Depth-of-field preview button (39)
- 10** Lens contacts*
- 11** Mirror*
- 12** Lens mount
- 13** Lens release button (→ *step 2 in “Read This First”*)
- 14** Focus mode lever (52, 101)
- 15** WB (White Balance) button (61)

- 16** Built-in flash* (→ *step 5 in “Read This First”*)
- 17** DRIVE button (55)
- 18** Mode dial (34)
- 19** HDMI terminal (90, 121, 148)
- 20** VIDEO OUT/ (USB) terminal (89, 129)
- 21**  Flash sync terminal (77)
- 22** REMOTE terminal (166)
- 23** DC IN terminal (165)

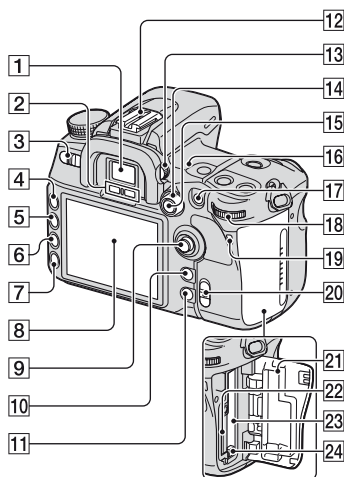

- 1** Viewfinder (→ *step 5 in “Read This First”*)
- 2** Eyepiece sensors (111)
- 3** POWER switch (→ *step 4 in “Read This First”*)
- 4** MENU button (32)
- 5** DISP (Display) button (23, 83)
- 6** (Delete) button (→ *step 6 in “Read This First”*)
- 7** (Playback) button (→ *step 6 in “Read This First”*)
- 8** LCD monitor (20, 23)
- 9** Multi-selector (29)
- 10** For shooting: C (Custom) button (81, 98)
For viewing: (Histogram) button (85)
- 11** For shooting: Fn (Function) button (30)
For viewing: (Rotate) button (88)
- 12** Accessory shoe (166)
- 13** Diopter-adjustment dial (→ *step 5 in “Read This First”*)
- 14** Metering mode lever (48)
- 15** For shooting: AEL (AE lock) button (43, 46)/SLOW SYNC button (77)
For viewing: (Index) button (84)
- 16** Image sensor position mark (50)
- 17** For shooting: AF/MF (Auto focus/manual focus) button (53)
For viewing: (Enlarge) button (86)
- 18** Rear control dial (30, 107)
- 19** Access lamp (→ *step 3 in “Read This First”*)
- 20** (Super SteadyShot) switch (→ *step 5 in “Read This First”*)
- 21** Memory card cover (→ *step 3 in “Read This First”*)
- 22** “Memory Stick Duo” insertion slot (→ *step 3 in “Read This First”*)
- 23** CF card insertion slot (→ *step 3 in “Read This First”*)
- 24** CF card eject lever (→ *step 3 in “Read This First”*)

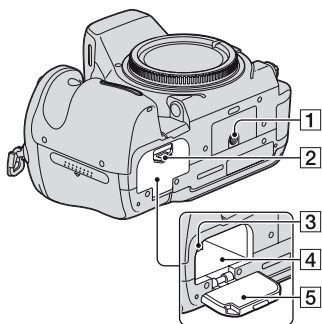

1 Tripod receptacle

- Use a tripod with a screw length of less than 5.5 mm (7/32 inch). You will be unable to firmly secure the camera to tripods having screws longer than 5.5 mm (7/32 inch), and may damage the camera.

2 Battery cover open lever (→ step 1 in “Read This First”)

3 Lock lever (→ step 1 in “Read This First”)

4 Battery insertion slot (→ step 1 in “Read This First”)

5 Battery cover (→ step 1 in “Read This First”)

Remote Commander

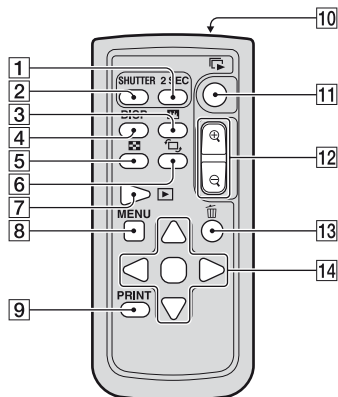

- With the exception of the 2 SEC and SHUTTER buttons, the buttons only work when the camera is connected to a TV (pages 60, 91, 148).

1 2 SEC (shutter release in 2 seconds) button

2 SHUTTER button

3 (Histogram) button (85)

4 DISP (Display) button (83)

5 (Index) button (84)

6 (Rotate) button (88)

7 (Playback) button (83)

8 MENU button (32)

9 PRINT button (148)

10 Transmitter

11 (Slide show) button (119)

12 (Scale up/down) buttons (86)

13 (Delete) button (→ step 6 in “Read This First”)

14 (29)

- Remove the insulation sheet before using the Remote Commander.

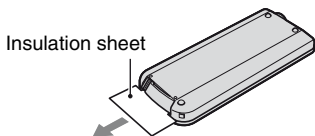

- Point the Remote Commander at the remote sensor on the front of the camera in order to operate the camera (page 14).

To change the battery of the Remote Commander

- While pressing on the tab, insert your fingernail into the slit to pull out the battery case.
- Place a new battery with the + side facing up.
- Insert the battery case back into the Remote Commander until it clicks.

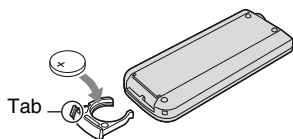

WARNING

Battery may explode if mistreated. Do not recharge, disassemble or dispose of in fire.

- When the lithium battery becomes weak, the operating distance of the Remote Commander may shorten, or the Remote Commander may not function properly. In this case, replace the battery with a Sony CR2025 lithium battery. Use of another battery may present a risk of fire or explosion.

Attaching the shoulder strap

This camera has two hooks to attach the shoulder strap. Attach the end of the strap without the remote commander clip on the grip side of the camera. Attach the other end of the strap on the other side of the camera.

Remote commander clip

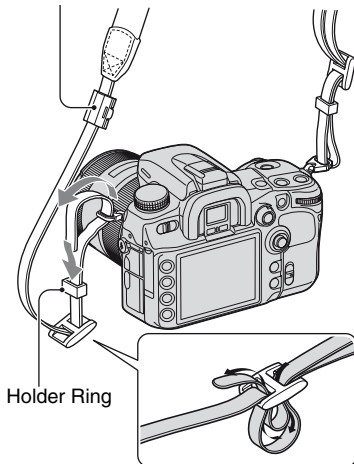

When threading the strap through the holder ring, hold the tip of the strap with your finger, and slide the holder ring rather than the tip of the strap into position to secure the strap.

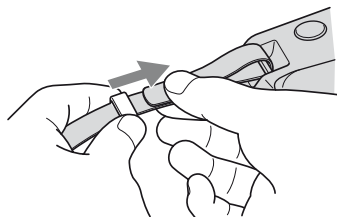

If the holder ring comes off the strap, put it back on the strap from the notched side.

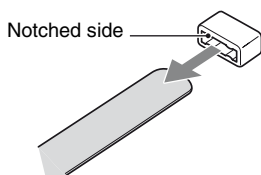

Indicators on the monitor

See the pages in parentheses for details of operation.

Viewfinder

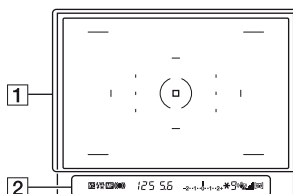

1

Display	Indication
	Local AF area (49)
	Spot AF area (49)
	Spot metering area (48)
	Shooting area for aspect ratio 16:9 (95)

2

Display	Indication
	Flash-compensation (75)
	Flashing: The flash is being charged Lit: The flash has been charged (→ step 5 in “Read This First”)
WL	Wireless flash (73)
H	High-speed sync (167)
MF	Manual focus (53)
	Focus (→ step 5 in “Read This First”)
125	Shutter speed (39)
5.6	Aperture (37)
-2+1+0+1+2+	EV scale (42, 47, 58)
	AE lock (46)
9	Shots-remaining counter (56)
	Camera-shake warning (→ step 5 in “Read This First”)

Display	Indication
	Super SteadyShot scale (→ step 5 in “Read This First”)
	Aspect ratio 16:9 (95)

LCD monitor (Recording information display)

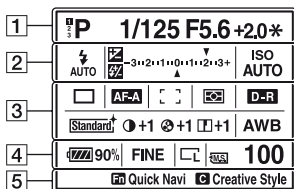

- The illustration above is for the full display in the horizontal position (page 23).

1

Display	Indication
	Register number (79)
	Mode dial (34)
	Shutter speed (39)
	Aperture (37)
	Exposure (45)
	AE lock (46)

2

Display	Indication
	Flash mode (73)/Red-eye reduction (110)
	Exposure-compensation (45)/Metered Manual (42)
	Flash-compensation (75)
	EV scale (42, 47, 58)
	ISO sensitivity (64)

3

Display	Indication
	Drive mode (55)
	Focus mode (52)
	AF area (49)
	Metering (48)
	D-range optimizer (66)
	Creative Style (67)
	Contrast, Saturation, Sharpness, Brightness, Zone Matching (68)
	White balance (Auto, Preset, Color temperature, Color filter, Custom) (61)

4

Display	Indication
	Battery remaining (→ step 1 in “Read This First”)
	Image quality (96)
	Image size (94)
	Memory card (123)
	Remaining number of recordable images (24)

5

Operation guide

The next operation may be indicated on the lower portion of the LCD monitor. The icons indicate the following meanings.

Display	Indication
	Multi-selector ◀▶
	Multi-selector ▲▼
	Multi-selector ▲▼◀▶
	Center of the multi-selector
	MENU button
	Returns with MENU
	Delete button
	Enlarge button
	C button
	Fn button
	▶ button
	Front or rear control dial
	Front control dial
	Rear control dial

LCD monitor (single-image playback)

	100-0003		DPOF3	FINE	
1/30 F4.0 ISO400					
2007 1 1 10:37PM 3/7					

Display	Indication
	Memory card (123)
100-0003	Folder - file number (133)
	Protect (115)
DPOF3	DPOF set (116)
RAW cRAW RAW+J cRAW+J X.FINE FINE STD	Image quality (96)
	Image size (94)
	Battery remaining (→ step 1 in "Read This First")
1/30	Shutter speed (39)
F4.0	Aperture (37)
ISO 400	ISO sensitivity (64)
2007 1 1 10:37PM	Date of recording
3/7	File number/total number of images

LCD monitor (Histogram display)

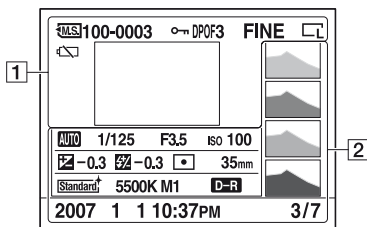

1

Display	Indication
	Memory card (123)
100-0003	Folder - file number (133)
	Protect (115)
DPOF3	DPOF set (116)
RAW cRAW RAW+J cRAW+J X.FINE FINE STD	Image quality (96)
 	Image size (94)
	Battery remaining (→ <i>step 1</i> in “Read This First”)
	Playback image (85)

2

Display	Indication
	Histogram (85)
AUTO P A S M 	Mode dial (34)
1/125	Shutter speed (39)
F3.5	Aperture (37)
ISO100	ISO sensitivity (64)
-0.3	EV scale (45)
-0.3	Flash-compensation (75)
	Metering mode (48)
35mm	Focal length (8)

Display	Indication
	Creative Style (67)
AWB +1 5500K M1	White balance (Auto, Preset, Color temperature, Color filter, Custom) (61)
	D-range optimizer (66)
2007 1 1 10:37PM	Date of recording
3/7	File number/total number of images

Switching the recording information display

When recording, the LCD monitor displays various recording information.

Press the DISP (Display) button to switch between the detailed display and the enlarged display. You can choose to turn off the display to minimize battery consumption.

When you rotate the camera to a vertical position, the display automatically rotates to adjust to the camera position.

Horizontal position

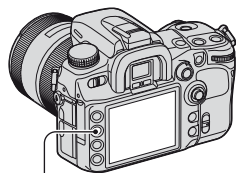

DISP (Display) button

Detailed display



Enlarged display



No display

Vertical position

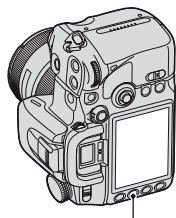

DISP (Display) button

Detailed display

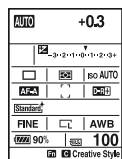

Enlarged display

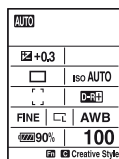

No display

- The instructions in this operating instructions are based on the detailed display in the horizontal position. (The upper-left illustration.)
- You can choose to keep the display from rotating in the vertical position with [Rec.info.disp.] in the ⚙ Custom menu (page 112)
- You can adjust the brightness of the LCD monitor by pressing the DISP (Display) button a little longer (page 120).
- For the screen displayed in playback mode, see page 83.

Number of images

The tables show the approximate number of images that can be recorded on a memory card formatted with this camera. The values may vary depending on the shooting conditions.

The number of images

“Memory Stick Duo”

Image size: L 12M (Aspect ratio: 3:2)

(Units: Images)

Capacity Size	128MB	256MB	512MB	1GB	2GB	4GB	8GB
Standard	31	57	120	245	496	982	1973
Fine	21	38	81	167	338	669	1344
Extra fine	11	20	43	89	180	358	720
cRAW & JPEG	6	11	24	51	103	204	410
RAW & JPEG	4	8	18	38	77	153	309
cRAW	9	17	35	73	148	293	590
RAW	6	11	24	50	100	199	401

Image size: L 10M (Aspect ratio: 16:9)

(Units: Images)

Capacity Size	128MB	256MB	512MB	1GB	2GB	4GB	8GB
Standard	36	65	136	280	565	1120	2250
Fine	24	44	94	193	390	773	1553
Extra fine	13	24	51	105	212	420	844
cRAW & JPEG	6	12	25	53	107	212	427
RAW & JPEG	5	9	19	39	80	158	318
cRAW	9	17	35	73	148	293	590
RAW	6	11	24	50	100	199	401

Image size: M 6.4M (Aspect ratio: 3:2)

(Units: Images)

Capacity Size	128MB	256MB	512MB	1GB	2GB	4GB	8GB
Standard	50	89	188	385	776	1536	3087
Fine	35	63	134	275	555	1099	2208
Extra fine	19	35	75	154	311	617	1240
cRAW & JPEG	7	13	28	57	117	231	465
RAW & JPEG	5	9	20	42	85	169	339

Image size: M 5.4M (Aspect ratio: 16:9)

(Units: Images)

Size \ Capacity	128MB	256MB	512MB	1GB	2GB	4GB	8GB
Standard	56	99	209	429	865	1712	3439
Fine	40	72	152	312	630	1248	2508
Extra fine	22	41	87	178	360	713	1433
cRAW & JPEG	7	13	29	59	120	237	477
RAW & JPEG	5	9	21	43	86	172	345

Image size: S 3.0M (Aspect ratio: 3:2)

(Units: Images)

Size \ Capacity	128MB	256MB	512MB	1GB	2GB	4GB	8GB
Standard	74	132	276	566	1142	2262	4543
Fine	56	101	212	435	877	1737	3489
Extra fine	33	59	125	256	517	1024	2057
cRAW & JPEG	8	14	30	62	126	251	504
RAW & JPEG	5	10	21	44	90	179	359

Image size: S 2.6M (Aspect ratio: 16:9)

(Units: Images)

Size \ Capacity	128MB	256MB	512MB	1GB	2GB	4GB	8GB
Standard	81	145	305	625	1262	2497	5016
Fine	62	112	236	484	977	1933	3883
Extra fine	38	68	143	294	593	1175	2360
cRAW & JPEG	8	14	31	63	128	255	512
RAW & JPEG	5	10	22	45	91	181	363

CF card**Image size: L 12M (Aspect ratio: 3:2)**

(Units: Images)

Capacity Size	256MB	512MB	1GB	2GB	4GB	8GB
Standard	64	129	255	500	1001	2000
Fine	43	87	174	341	682	1363
Extra fine	23	46	93	182	365	730
cRAW & JPEG	13	26	53	103	208	415
RAW & JPEG	10	20	40	78	156	313
cRAW	19	38	76	149	299	598
RAW	13	26	52	101	203	406

Image size: L 10M (Aspect ratio: 16:9)

(Units: Images)

Capacity Size	256MB	512MB	1GB	2GB	4GB	8GB
Standard	73	147	291	570	1142	2281
Fine	50	101	201	393	788	1574
Extra fine	27	55	109	214	428	856
cRAW & JPEG	13	27	55	108	217	433
RAW & JPEG	10	20	41	80	161	323
cRAW	19	38	76	149	299	598
RAW	13	26	52	101	203	406

Image size: M 6.4M (Aspect ratio: 3:2)

(Units: Images)

Capacity Size	256MB	512MB	1GB	2GB	4GB	8GB
Standard	100	202	400	783	1567	3129
Fine	71	144	286	560	1121	2239
Extra fine	40	81	160	314	629	1257
cRAW & JPEG	15	30	60	118	236	472
RAW & JPEG	11	22	44	86	172	344

Image size: M 5.4M (Aspect ratio: 16:9)

(Units: Images)

Size \ Capacity	256MB	512MB	1GB	2GB	4GB	8GB
Standard	112	225	446	872	1746	3487
Fine	81	164	325	636	1273	2542
Extra fine	46	93	185	363	727	1452
cRAW & JPEG	15	31	61	121	242	484
RAW & JPEG	11	22	44	87	175	350

Image size: S 3.0M (Aspect ratio: 3:2)

(Units: Images)

Size \ Capacity	256MB	512MB	1GB	2GB	4GB	8GB
Standard	148	298	589	1152	2307	4605
Fine	113	228	452	885	1772	3537
Extra fine	66	134	266	522	1044	2086
cRAW & JPEG	16	33	65	128	256	511
RAW & JPEG	11	23	46	91	182	364

Image size: S 2.6M (Aspect ratio: 16:9)

(Units: Images)

Size \ Capacity	256MB	512MB	1GB	2GB	4GB	8GB
Standard	163	329	650	1273	2547	5085
Fine	126	254	503	985	1972	3937
Extra fine	76	154	306	598	1198	2392
cRAW & JPEG	16	33	66	130	260	519
RAW & JPEG	11	23	47	92	184	368

The number of images that can be recorded when using the battery pack

The table shows the approximate number of images that can be recorded when you use the camera with the battery pack (supplied) at full capacity and at an ambient temperature of 25°C (77°F). The numbers of images that can be recorded take into account changing the memory card as necessary.

Note that the actual numbers may be less than those indicated depending on the conditions of use.

Memory card	No. of images
“Memory Stick Duo”	Approx. 650
CF card	Approx. 650

- Shooting in the following situations:
 - [Quality] is set to [Fine].
 - Focus mode is set to AF-A (Automatic AF).
 - Shooting once every 30 seconds.
 - The flash strobes once every two times.
 - The power turns on and off once every ten times.
- The measurement method is based on the CIPA standard.
(CIPA: Camera & Imaging Products Association)
- The number of shooting images does not change, regardless of image size.
- The battery capacity decreases as the number of uses increases and also over time (page 163).
- The number of images that can be recorded is decreased under the following conditions:
 - The surrounding temperature is low.
 - The flash is used frequently.
 - The camera has been turned on and off many times.
 - Focus mode is set to AF-C (Continuous AF).
 - The battery power is low.
- When using a Microdrive, the number of images recordable may differ.

Basic operation

How to use the multi-selector

You can select and execute the various functions using the multi-selector. While viewing images, you can select playback images using the multi-selector.

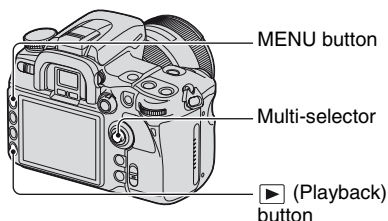

The directions in which the multi-selector is moved are expressed as follows in this operating instructions.



Up: ▲
Down: ▼
To the right: ►
To the left: ◀

Examples:

To select menu items

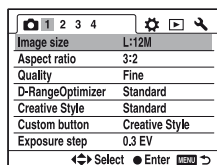

Moving the multi-selector to ▲/▼/◀/▶ moves the cursor in the corresponding direction. Pressing the center of the multi-selector enters the selected item.

To select playback images



On the single screen
Select a previous or next image by moving the multi-selector to ◀/▶.



On the index screen
Select the desired image by moving the multi-selector to ▲/▼/◀/▶.

How to use the Fn (Function) button

Using the Fn (Function) button, you can switch the recording information screen (page 23) to the Quick Navi screen. On the Quick Navi screen, you can change settings directly. In addition to the Quick Navi screen that can be controlled from the recording information screen, the Exclusive disp screen that switches the display to each exclusive screen is available.

In this operating instructions, examples use the Quick Navi screen for explanations.

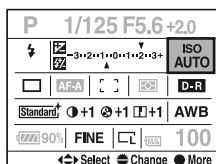

Quick Navi screen

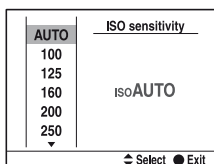

Exclusive disp screen

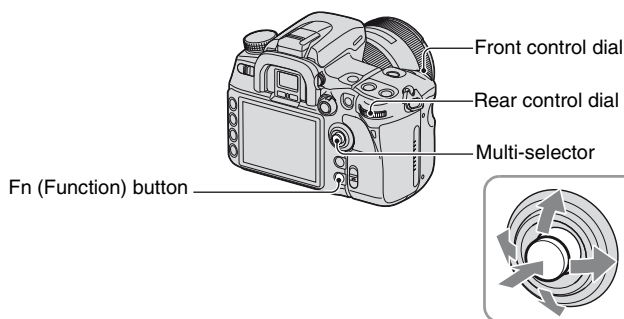

How to operate on the Quick Navi screen

- 1 Press the Fn (Function) button so that the Quick Navi screen appears.

2 Select the desired item with the multi-selector.

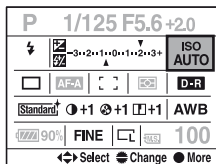

3 Set the item with the front or rear control dial.

For details on how to set up each item, see the corresponding page.

- When using Creative Style (page 67), some of the setup tasks can be accomplished only on the Exclusive disp screen.

How to operate on the Exclusive disp screen

1 Follow steps 1 and 2 on the procedure of “How to operate on the Quick Navi screen”.

2 Press the center of the multi-selector so that the Exclusive disp screen appears.

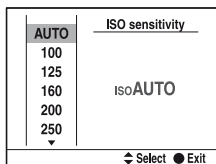

3 Set up with the multi-selector.

For details on how to set up each item, see the corresponding page.

- You can also substitute the front and rear control dials for the multi-selector.

Operations available from the Quick Navi screen are:

Exposure	page 45
AF area	page 49
Drive mode	page 55
White Balance	page 61
ISO	page 64
D-Range Optimizer	page 66
Creative Style*	page 67
Flash mode*	page 73
Flash compensation	page 75
Image size	page 94
Image quality	page 96

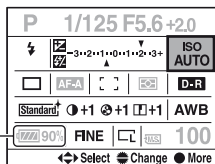

Gray items are not available.

* Unavailable on the enlarged display screen (page 23). Operate from the Recording menu.

How to use the menu

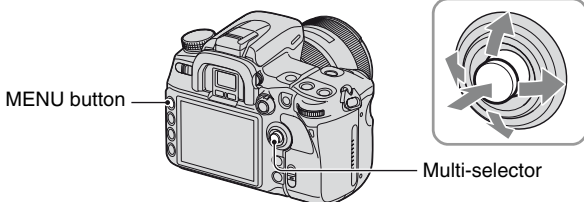

1 Press the MENU button to display the menu.

2 Move the multi-selector to to select the desired menu page.

- Recording menu [1, 2, 3, 4]
- Custom menu [1, 2, 3, 4]
- Playback menu [1, 2]
- Setup menu [1, 2, 3]

Menu now selected Menu not selected

Menu now selected	Menu not selected
1 2 3 4	
Image size L:12M	
Aspect ratio 3:2	
Quality Fine	
D-Range Optimizer Standard	
Creative Style Standard	
Custom button Creative Style	
Exposure step 0.3 EV	
Select	Enter

- 3** Move the multi-selector to ▲/▼ to select the desired item, then press the center.

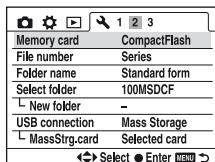

- 4** Move the multi-selector to ▲/▼ to select the desired setting, then press the center.

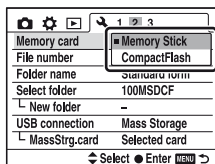

- 5** Press the MENU button to turn off the menu.

The menu is also turned off if you press the shutter button halfway down.

- When setting the menu, you can substitute the front or rear control dial for the multi-selector. Rotating the front control dial moves the cursor to ▲/▼ and rotating the rear control dial moves it to ◀/▶.
- During operation, if you press the MENU button, the setup is canceled.
- When you display a menu, you can display the previously selected menu first with [Menu start] in the  Setup menu (page 125).

Using the mode dial

Set the mode dial to the desired function.

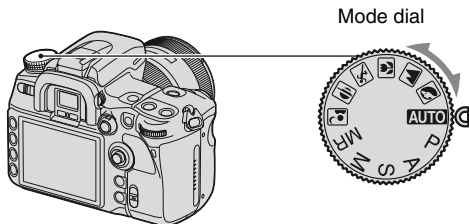

Recording modes

AUTO: **Auto adjustment mode**

Allows easy shooting with the settings adjusted automatically, depending entirely on the camera. → *step 5 in “Read This First”*

 : **Scene Selection mode**

Allows you to shoot with preset settings according to the scene (page 35).

P: **Program auto mode**

Allows you to shoot with the exposure adjusted automatically (both the shutter speed and the aperture value). The other settings can be adjusted, and your setting values can be saved (page 36).

A: **Aperture priority mode**

Allows you to shoot after adjusting the aperture value manually (page 37).

S: **Shutter speed priority mode**

Allows you to shoot after adjusting the shutter speed manually (page 39).

M: **Manual exposure mode**

Allows you to shoot after adjusting the exposure manually (both the shutter speed and the aperture value) (page 41).

MR: **Memory recall mode**

Allows you to recall a setup registered in [Memory] in the  Recording menu (page 79).

Scene Selection

You can shoot with the following preset settings according to the scene.

- You can change any of the settings except Creative Style (page 67) but the settings are reset by choosing another mode or turning off the power.

Portrait



Shoots with backgrounds blur away, and the subject is sharpened.

- To blur the background more, using the telephoto position of the lens is more effective.
- It is recommended that you use the flash when the subject is backlit. Also, when you do not use the flash, it is recommended that you use the lens hood to prevent unnecessary light from seeping into the lens.

Landscape



Shoots scenery with vivid and sharp colors.

- It is recommended that you push down the flash not to fire the flash.
- The shutter speed becomes slower when the subject is dark. If  appears in the viewfinder, be careful about camera shake or use a tripod. The Super SteadyShot function is also effective.

Macro



Shoots close subjects such as flowers, insects.

You can achieve clear and sharp focus.

- When shooting with the built-in flash within the range of 1 m (39 3/8 inches), shadows may appear on the lower part of the image. Do not use with the built-in flash.
- The minimum recording distance is not changed even if you select Macro. To shoot a larger image, using a macro lens is recommended.

Sports action



Shoots moving subjects outdoors or in bright places.

- The camera continues to focus while the shutter button is pressed and held halfway down (Continuous AF, page 52).
- The camera shoots the image continuously while the shutter button is pressed (Continuous adv., page 56).
- Do not use the flash if the subject is out of the flash range (Push the built-in flash back down). Flash range → page 65

Sunset



Shoots the red of the sunset beautifully.

Night view/portrait

- The shutter speed is slower, so using a tripod is recommended. The Super SteadyShot function is also effective.



Night portrait

Shoots portraits in night scenes.

Pull up the flash to use it.

- Take care that the subject does not move to prevent the image from blurring.



Night view

Shoots night scenes at a distance without losing the dark atmosphere of the surroundings.

Do not use the flash (Push the flash back down).

- The picture may not be taken properly when shooting a wholly dark night scene.

Shooting with program auto – P

In program auto mode, the camera automatically adjusts the shutter speed and the aperture according to the brightness of the subject just as in the auto adjustment mode (mode dial: AUTO).

The difference between auto adjustment mode and program auto mode

In both auto adjustment and program auto mode, the shutter speed and aperture are automatically adjusted.

You can change other settings. In auto adjustment mode, the new settings will be reset when another mode is selected or the power is turned off.

In program auto mode, the new settings will be maintained if another mode has been selected or the power has been turned off.

When the camera is in auto adjustment mode and the flash is up, the camera flashes automatically whenever it is necessary. When the camera is in program auto mode and the flash is up, the camera always flashes when it shoots.

Program shift

You can temporarily change the aperture value and shutter speed combination that was adjusted by the camera.

There are two methods for the program shift function.

P_S shift: You can choose the desired shutter speed. The aperture value is adjusted automatically.

P_A shift: You can choose the desired aperture value. The shutter speed is adjusted automatically.

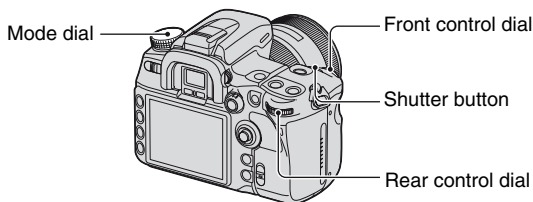

- ① Set the mode dial to P.
- ② Hold the grip and look into the viewfinder or press the shutter button halfway down until the shutter speed and aperture value are displayed in the viewfinder.
- ③ While the shutter speed and aperture value are displayed, select the shutter speed using the front control dial or select the aperture value using the rear control dial.

P_S shift

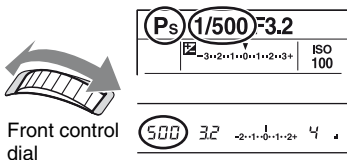

P_A shift

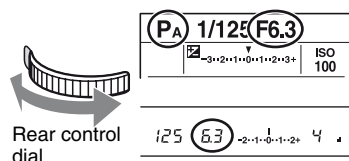

- You can switch the P_S shift and the P_A shift with [Ctrl dial setup] in the ⚙ Custom menu (page 107).
- When the shutter speed and the aperture value are displayed, you no longer have to keep pressing the shutter button.
- When the shutter speed and the aperture value disappear seconds later, the adjusted values also disappear.
- When the flash is pulled up, you cannot select the program shift. When the program shift is turned on, pulling up the flash cancels the program shift.

Shooting with aperture priority mode – A

You can adjust the aperture manually. If you open the aperture (a smaller F-number), the in-focus range becomes narrower. Only the main subject is then in focus. When the aperture is closed (a larger F-number), the in-focus range becomes wider. The whole image is sharpened. The shutter speed is automatically adjusted.



Open the aperture



Close the aperture

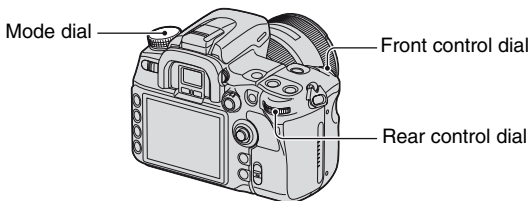

- ① Set the mode dial to A.
- ② Select an aperture value using the front or rear control dial.

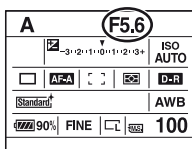

- The aperture range depends on the lens.
- The aperture value is adjusted in 1/3 EV increments. You can set this exposure step to 1/2 EV increments with [Exposure step] in the Recording menu (page 98).
- If the proper exposure is not obtained after making the settings, the shutter speed on the LCD monitor and in the viewfinder flashes when the shutter button is pressed halfway down. You can shoot at this point, but adjusting again is recommended.
- When the flash is pulled up, the flash fires regardless of the amount of ambient light (page 73).
- When using the flash, if you close the aperture (a larger F-number), the flash light does not reach a distant subject. Opening the aperture (a smaller F-number) is recommended.
- If you close the aperture (a larger F-number), the amount of light passing through the lens is decreased and the shutter speed becomes slower. Using a tripod is recommended.

Shooting techniques

The depth of field is the in-focus range. Opening the aperture makes the depth of field shallower (the in-focus range becomes narrower) and closing the aperture makes the depth of field wider (the in-focus range becomes wider).

Open the aperture

The subject is sharpened with its background blurred.



Close the aperture

Over a wide range, both nearby and faraway subjects are brought into focus.



Adjust the aperture to suit your purpose, either to sharpen the specific area of image, or to focus on the entire image.

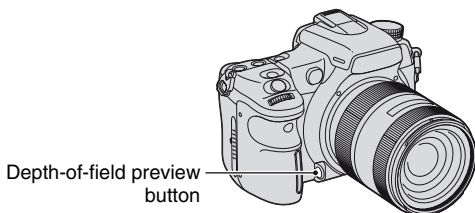

Depth-of-field preview

The viewfinder shows an image captured with the widest aperture. The change in aperture affects the sharpness of the subject image, creating a discrepancy between the sharpness seen in the viewfinder and in the actual picture. The preview function enables you to see the image with the aperture used in the actual shooting, allowing you to check the approximate sharpness of the subject image before the actual shooting.



Press the depth-of-field preview button after the subject is in focus.

While the button is held down, the aperture is narrowed to match the aperture value displayed in the viewfinder.

- The image in the viewfinder will be darker.
- When the focus is not fixed and the depth-of-field preview button is pressed, you cannot take a picture. To take a picture, press the depth-of-field preview button with  lit in the viewfinder.
- With a lens equipped with a focus hold button, you can set the camera to perform the preview function using the focus hold button with [FocusHoldButton] in the  Custom menu (page 106).

Shooting with shutter speed priority mode – S

You can adjust the shutter speed manually. If you shoot a moving subject at a higher shutter speed, it appears as if frozen on the image. At a lower shutter speed, the subject appears as if it flowing.

Aperture value is automatically adjusted.



High shutter speed



Slow shutter speed

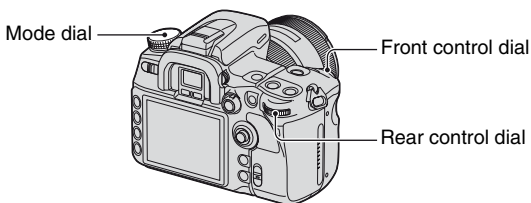

- ① Set the mode dial to S.
- ② Select a shutter speed using the front or rear control dial.

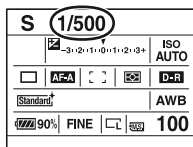

- You can adjust the shutter speed between 30 and 1/8000 second. You can adjust it between 30 and 1/200 second (with the Super SteadyShot function activated) or 30 and 1/250 second (with the Super SteadyShot function deactivated) when using the flash.
- The shutter speed is adjusted in 1/3 EV increments. You can set this exposure step to 1/2 EV increments with [Exposure step] in the Recording menu (page 98).
- If the proper exposure is not obtained after making the settings, the aperture value on the LCD monitor and in the viewfinder flashes when the shutter button is pressed halfway down. You can shoot at this point, but adjusting again is recommended.
- When the flash is pulled up, the flash fires regardless of the amount of ambient light (page 73).
- When using the flash, if you close the aperture (a larger F-number) by making the shutter speed slower, the flash light does not reach a distant subject.
- When the shutter speed is one second or more, the noise reduction (Long exp.NR) will be done after shooting (page 103).
- The (Camera-shake warning) indicator does not appear in the shutter speed priority mode.

Shooting techniques



When shooting a moving person, car, or spindrift, etc., using the high shutter speed, you can express moment that is beyond what the human eye can see.



When shooting a subject such as the flow of a river at a slower shutter speed, you can create an image that captures the subject's flowing movement. In such cases, use of a tripod is recommended to prevent camera shake.

Manual exposure

You can manually adjust the shutter speed and aperture values.

This mode is useful when you maintain the setting of the shutter speed and the aperture value or when you use an exposure meter.

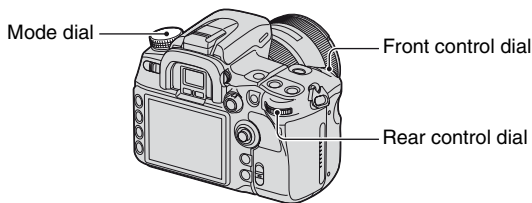

- ① Set the mode dial to M.
- ② Select a shutter speed using the front control dial and an aperture value using the rear control dial.



M	1/500	F5.6		
MM	-3 · 2 · 1 · 0 · 1 · 2 · 3 +	ISO	200	
	AF-A	□	□	D-R
Standard			AWB	
90%	FINE	□	100	



M	1/500	F4.5		
MM	-3 · 2 · 1 · 0 · 1 · 2 · 3 +	ISO	200	
	AF-A	□	□	D-R
Standard			AWB	
90%	FINE	□	100	

- “BULB” (Bulb shooting) is indicated next to “30” (page 43).

- In the manual exposure mode, even when [ISO sensitivity] (page 64) is set to [AUTO], it is fixed to ISO 200.
- You can exchange their functions of the front and rear control dials with [Ctrl dial setup] in the Custom menu (page 107).
- When the flash is pulled up, the flash fires regardless of the amount of ambient light (page 73).
- The (Camera-shake warning) indicator does not appear in the manual exposure mode.

EV scale

The EV scale on the LCD monitor and in the viewfinder indicates the difference between the standard exposure (0.0 EV) determined by the camera meter and the set exposure determined by the shutter speed, and the aperture specified by the photographer (Metered Manual).

	The set exposure specified by the photographer is the same as the exposure determined by the meter.	The set exposure specified by the photographer is 1.0 EV more (+) than the standard exposure determined by the meter.	The ◀▶ arrow appears if the set exposure is beyond the range of the EV scale. The arrow starts flashing if the difference becomes greater.
LCD monitor			
Viewfinder			

: Metered Manual

- If the exposure is adjusted, the standard exposure (0.0 EV) is shifted by just the corresponding amount of the adjustment.

How to use the AEL button in manual mode

While you press and hold the AEL (AE lock) button, the exposure determined by the meter is locked as the standard exposure (0.0 EV). When you recompose your shot with the AEL (AE lock) button pressed, an exposure value within the spot metering circle appears as the second standard index.

The following illustrations show a case where the set exposure specified by the photographer is 1.0 EV more than the locked standard exposure determined by the meter. When the composition is changed in the viewfinder, the exposure within the spot metering circle is 0.7 EV more than the set exposure, thereby making it 1.7 EV more than the standard exposure determined by the meter.

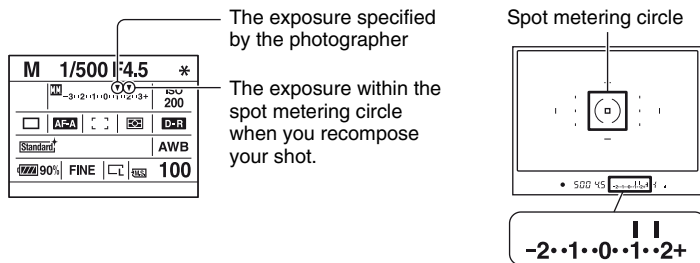

Manual shift

You can change the shutter speed and aperture value combination without changing the exposure in manual mode.

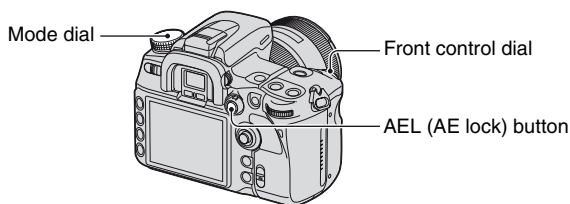

- ① Set the mode dial to M.
- ② Select a shutter speed and aperture value (page 41).
- ③ Press and hold the AEL (AE lock) button and turn the front control dial to select the desired shutter speed and aperture value combination.

BULB (long exposure) shooting

As long as the shutter button is pressed, the shutter remains open. You can shoot trails of light, such as fireworks. Attach a tripod to the camera when using the bulb shooting function.

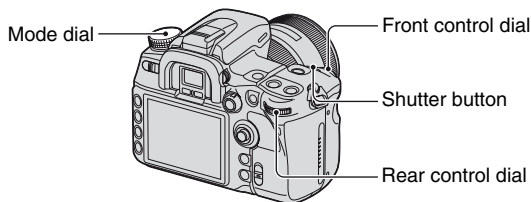

- ① Set the mode dial to M.
- ② Rotate the front control dial to the left until [BULB] is indicated.

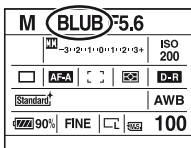

- ③ Rotate the rear control dial to select the aperture.
 - ④ Attach the eyepiece cover (See below).
 - ⑤ Press and hold the shutter button for the duration of the shooting.
- You can shoot in bulb exposure mode up to about four and a half hours using a fully charged battery pack.
 - After shooting, the noise reduction will be done for the same amount of time that the shutter was open. When the message “Processing...” appears, you cannot do any further shooting. You can cancel this function with [Long exp.NR] in the Recording menu (page 103).
 - The Super SteadyShot function is automatically turned off.
 - The higher the ISO sensitivity, or the longer the exposure time, the more outstanding the noise on the monitor.
 - To reduce camera-shake, connecting the Remote Commander is recommended (pages 60, 166).

To attach the eyepiece cover

When the shutter is released without the use of the viewfinder, as in bulb exposure or shooting with the self-timer, attach the eyepiece cover to prevent light from entering through the viewfinder and affecting the exposure.

- ① Carefully slide the eyecup off by pushing on each side of the eyecup.

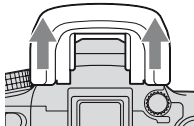

- ② Slide the eyepiece cover over the viewfinder. The cover is normally attached to the shoulder strap.

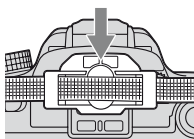

Exposure

Exposure is the amount of light that the camera will receive when you release the shutter. The exposure is automatically set to the proper value in the auto adjustment mode. However, you can set the exposure to your desired setting in the following setup.

Adjusting the exposure

You can manually shift the exposure value determined by the camera. Use this mode when you brighten or darken the overall screen.

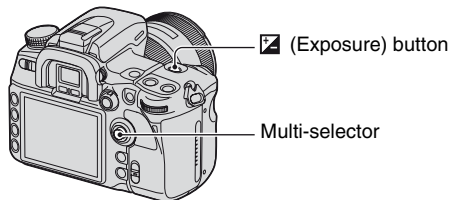

- 1 Press the \square (Exposure) button to display the Exposure comp. screen.

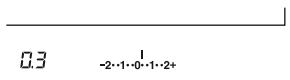
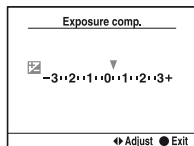

The compensation level is also checked on the EV scale in the viewfinder.

- 2 Adjust the exposure with $\blacktriangleleft/\blacktriangleright$ on the multi-selector.



Toward -



Toward +

Toward +: Brightens an image.

0: The exposure is determined automatically by the camera.

Toward -: Darkens an image.

- You can substitute the Fn (Function) button for the \square (Exposure) button (page 30).
- The exposure is compensated by 1/3 of a step between ± 3.0 EV. You can set this exposure step to 1/2 EV increments with [Exposure step] in the \square Recording menu (page 98).

Shooting techniques

When shooting a whitish overall image such as a backlit subject or a snowy scene, the camera judges that the subject is too bright and may set a darker exposure for the image. In such cases, adjustment of the exposure in the + plus direction is effective.



Adjust in the + direction

When shooting a darker overall image, the camera judges that the subject is too dark and may set a brighter exposure for the image. In such cases, adjustment of the exposure in the – minus direction is effective.



Adjust in the – direction

Locking the exposure (AE lock)

You can fix the exposure before deciding on the composition when taking a picture. This is effective when the metering object and focusing object are different, or when you want to shoot continuously while keeping the same exposure value.

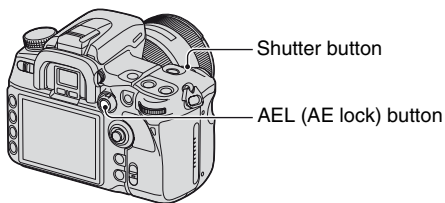

- ① Target the subject for which you want to meter the exposure.
 - Adjust the focus (you do not need to lock the focus.)
 - ② Press the AEL (AE lock) button.
 -  lights up in the viewfinder and on the LCD monitor to indicate that the exposure is locked.
 - ③ While pressing the AEL (AE lock) button, recompose the image, if necessary, and press the shutter button to take the picture.
- If the AEL (AE lock) button is kept down after a shot, you can continue to shoot with the same exposure value. The setting is canceled when the button is released.
 - When the flash is fired in a mode other than shutter speed priority mode or manual mode, the slow sync shooting is performed (page 77).

- You can set the camera to keep the exposure value after releasing the AEL (AE lock) button or to temporarily perform spot metering with [AEL button] in the Custom menu (page 107).

About the EV scale when the AEL (AE lock) button is pressed

While you press the AEL (AE lock) button, an exposure value determined by the camera is locked as the standard value (0). At the same time, an exposure value within the spot metering circle appears as the second standard index.

- If the exposure is beyond the range of the EV scale, appears at the end of the EV scale. The starts flashing if the difference becomes any greater.

Example: When the composition is determined in the scene below and the AEL (AE lock) button is pressed

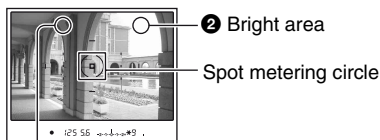

① Slightly darker area

The indicator displays are as follows when the AEL (AE lock) button is pressed.

	AEL (AE lock) button is pressed	Recompose on ① while holding the AEL (AE lock) button down	Recompose on ② while holding the AEL (AE lock) button down
Multi segment/ Center-weighted metering	<p>The locked exposure</p> <p>The light level within the spot metering circle is 0.3 EV less than the locked exposure (varies according to the recomposition of the shot).</p>	<p>The locked exposure</p> <p>The light level of ① is 1.3 EV less than the locked exposure (varies according to the recomposition of the shot).</p>	<p>Turn the camera on ② and the light level of ② is displayed. The arrow indicates ② will white out.</p>
Spot metering	<p>The locked exposure is equal to the light level within the spot metering circle.</p>	<p>The locked exposure</p> <p>The light level of ① is 1.0 EV less than the locked exposure (varies according to the recomposition of the shot).</p>	

Selecting the metering mode

You can select a metering mode (a method whereby the camera measures the brightness of a subject).

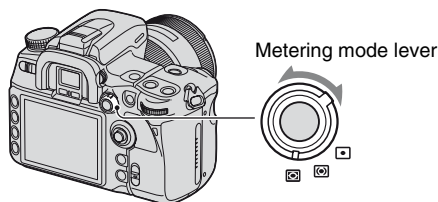

Set the metering mode lever to the desired mode.

(Multi segment)

This divides the whole screen into 40 segments to measure light (40-segment honeycomb pattern metering). This is suitable for general shooting, including shooting into direct sunlight.

(Center weighted)

While emphasizing the central area of the screen, this mode measures the average brightness of the entire screen. If you shoot directly into the sunlight or the subject is not in the center of the image, you must use exposure compensation (page 45).

(Spot)

This mode measures light only in the spot metering circle in the center of the frame. This is suitable for shooting a subject with strong contrast or measuring the light of a specific area of the screen. If the area to be measured is not in the center of the screen, use AE lock to take the picture (page 46).

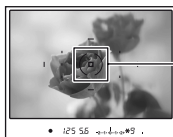

Spot metering area
Position of the subject.

Multi segment metering

The screen of this camera is equipped with 39 honeycomb shaped metering elements and one metering element that covers the surrounding area. These elements work in sync with auto focus, allowing the camera to accurately measure the position and brightness of the subject in order to determine the exposure.

- In multi segment metering, if the focus is locked, the exposure (the shutter speed and the aperture) is locked simultaneously (only when **AF-S** (Single-shot AF) or **AF-A** (Automatic AF)).

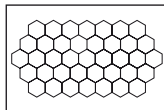

Focus

When you hold the grip and look into the viewfinder, or press the shutter button halfway down, the camera adjusts the focus automatically (Auto focus). Make it a habit to press the shutter button only halfway down to confirm that the subject is visually in focus.

Setting the AF area

You can change the focus method. Change the method when it is difficult to get the proper focus.

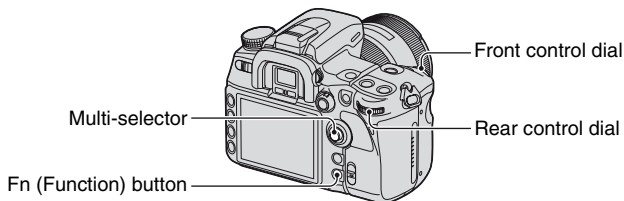

- ① Press the Fn (Function) button to display the Quick Navi screen (page 30).
- ② Select the AF area item with the multi-selector.

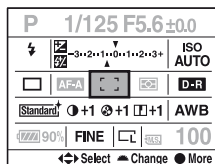





- ③ Select the desired mode with front or rear control dial.

- After selecting the AF area in step ②, if you press the center of the multi-selector, the screen switches to the Exclusive disp screen. On this screen, select the desired mode with ▲/▼ on the multi-selector, then press the center.
- You can also select the AF area from the Recording menu (page 101).

(✓ : The default setting)

✓	[] (Wide)	<p>The camera determines which of the 11 AF area is used in focusing within the wide AF area.</p>  <p>AF area</p>
---	------------	--

 (Spot)	<p>The camera uses the spot AF area exclusively.</p>  <p>Spot AF area</p>
 (Local)	<p>Choose a local AF area from the 11 areas. Select a local AF area that you want to activate the focus with the multi-selector. Press the center of the multi-selector to use the spot AF area in focusing.</p>  <p>Local AF area</p> <p>Spot AF area</p> <ul style="list-style-type: none"> • After shooting, area selection is still available. Be sure not to move the multi-selector unless it is necessary.

- The local AF area that was used to focus on is illuminated briefly.
- The local AF area may not be illuminated when continuous shooting is performed or when the shutter button is pressed all the way down without pause.

Subjects that may require special focusing:

Using the auto focus, it is hard to focus on the following subjects. In such cases, use the focus lock shooting feature (page 51) or manual focus (page 53).

- A subject that is low in contrast, such as blue sky or a white wall.
- Two subjects at different distances overlapping in the AF area.
- A subject that is composed of repeating patterns, such as the facade of a building.
- A subject that is very bright or glittering, such as the sun, the body of an automobile, or the surface of water.

To measure the exact distance to the subject

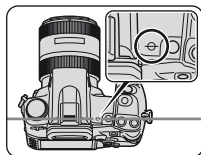

The  mark located on the top of the camera shows the location of the image sensor*. When you measure the exact distance between the camera and the subject, refer to the position of the horizontal line.

* The image sensor is the part of the camera that acts as the film.

💡 Shooting techniques

When the subject is outside the AF area (Focus-lock)



If the subject is off-center and outside the AF area, the background within the AF area will be in focus and the subject will be out of focus. To prevent this, lock the focus by following the steps below.

- 1 Place the subject within the AF area and press the shutter button halfway down.
- 2 Keep the shutter button halfway down, and put the subject back in the original position to re-compose the shot.



- 3 Press the shutter button fully down to take the picture.

If anything but the subject is in the AF area

When [] (Wide) is selected (the default setting), an undesired subject that is located in another area may be in focus. In such cases, pressing the center of the multi-selector focuses on the center area even if [] (Spot) is not selected.

Press and hold the center of the multi-selector, then shoot the subject.

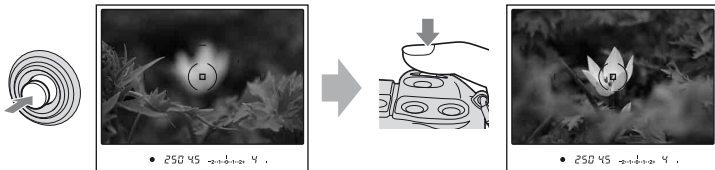

Selecting the focus mode

You can select the focus operation mode.

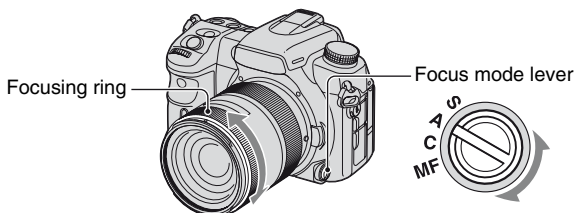

Set the focus mode lever to the desired mode.

Auto focus

S (AF-S Single-shot AF)

The camera focuses on and the focus is locked when you press the shutter button halfway down. This mode is used when shooting a motionless subject.

A (AF-A Automatic AF)

This AF mode automatically switches between Single-shot AF and Continuous AF. When you press and hold the shutter button, if the subject is motionless, the focus is locked and if the subject is in motion, the camera continues to focus. This mode is used in various situations.

- You can substitute DMF (Direct Manual Focus) for AF-A with [AF-A setup] in the  Recording menu (page 101).

C (AF-C Continuous AF)

In this mode, the camera continues to focus while the shutter button is pressed and held halfway down. This mode is used when the subject is in motion.

- If the Wide AF area is selected, the AF area switches to match the position of the subject.
- The audio signal will not sound when the subject is in focus.

Manual focus

MF (MF Manual focus)

You can set the distance of a subject.

Rotate the focusing ring of the lens to achieve a sharp focus.

- In the case of a subject that can be focused in auto focus mode, the ● indicator lights up in the viewfinder when the focus is confirmed. When the Wide AF area is used, the center area is used, and when the Local AF area is used, the area that is selected with the multi-selector is used.
- To obtain steady exposure in manual focus mode, the camera uses the distance information to determine the exposure. To improve the precision of the distance information, the camera resets the focal length to ∞ (infinity) when the POWER switch is set to ON.
- When using a tele converter, etc., rotation of the focusing ring may not be smooth.

Switching the AF/MF easily

The focus mode can be switched not only with the focus mode lever located on the front of the camera, but also with the AF/MF button located on the rear. You can switch between auto focus and manual focus without relaxing your position (AF/MF control).

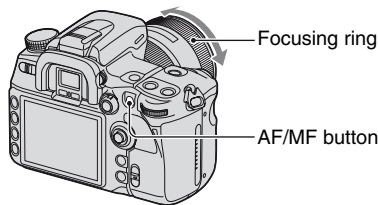

In auto focus mode

By pressing the AF/MF button, the focus mode is switched temporarily to the manual focus. Press and hold the AF/MF button and adjust the focus by rotating the focusing ring.

In manual focus mode

By pressing the AF/MF button, the focus mode is switched temporarily to the auto focus and the focus is locked. In the case where the manual focus is used mainly, this is convenient to activate the auto focus only when you need to use it.



- You can set the AF/MF button to work as the AF lock button with [AF/MF button] in the ⚙ Custom menu (page 105).
- You can maintain the selected mode without pressing and holding the AF/MF button with [AF/MF control] in the ⚙ Custom menu (page 106).

Using AF illuminator

In the auto focus mode, even when you shoot a subject under dark conditions or a low contrast subject, the AF illuminator allows the camera to focus more easily on a subject.

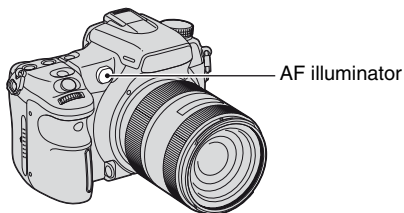
Press the shutter button half way down, a red illuminator is automatically emitted until the focus is locked to focus more easily on a subject.



- The range of the AF illuminator is approximately 1 to 7 m (3.3 to 23 feet).
- AF illuminator does not operate when the focus mode is set to Continuous AF or the subject is moving. (The  or  indicator lights in the viewfinder)
- The AF illuminator may not operate with focal lengths of 300 mm or longer.
- When an external flash is attached, the AF illuminator of the external flash is used.
- You can deactivate the AF illuminator with [AF illuminator] in the  Recording menu (page 102).
- The AF illuminator does not operate when the center area is not selected with AF area set to Local AF area.

Drive mode

You can use continuous shooting, self-timer, bracket, and shooting using the Remote Commander, with the DRIVE button.

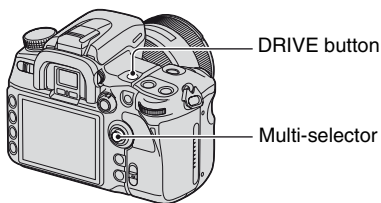

- 1** Press DRIVE to display the drive mode screen.
- 2** Select the desired mode with ▲/▼ on the multi-selector, then select the desired setting with ◀/▶ on the multi-selector.

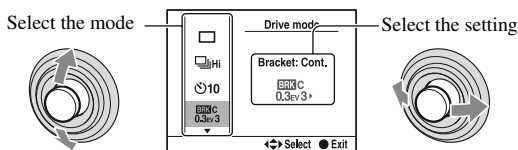

- 3** Press the center of the multi-selector to turn off the screen.

(✓: The default setting)

✓	<input type="checkbox"/>	Single-shot adv. • Also used for canceling other drive modes.
	Hi Lo	Continuous adv. (page 56)
	10 2	Self-timer (page 57)
	C 0.3ev-3	Bracket: Cont. (page 57)
	S 0.3ev-3	Bracket: Single (page 58)
	WB Lo3	WB bracket (page 59)
	DRO Lo3	DRO adv. bracket (page 59)
		Remote Commander (page 60)

• You can substitute the Fn (Function) button for the DRIVE button (page 30).

Shooting continuously

When you press and hold the shutter button, the camera records the images continuously.

 **Hi** Shoots at a maximum of 5 images per second*

 **Lo** Shoots at a maximum of 3 images per second*

* Our measurement conditions: [Image size] is set to [L:12M], [Quality] is set to [Fine], the focus mode is set to **AF-S** (Single-shot AF) or **MF** (Manual focus), and the shutter speed is 1/250 second or faster. However, the speed of continuous shooting is slower when shooting under dark conditions or the D-Range Optimizer is set to **DRn** (Advanced Auto) or **DRp** (Advanced: Level).

- The number of images that can be shot continuously is indicated in the viewfinder, and when shooting continuously, this number decreases.

After the images have been recorded on the memory card, the number returns to the original number, depending on the camera memory buffer.

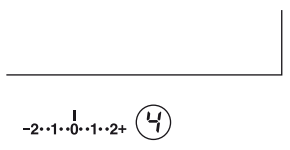

- When the built-in flash is fired, images are shot after the flash has been charged.
- When the focus mode is set to Continuous AF or Automatic AF, the focus is set separately on each image. When set to Single-shot AF, the focus is fixed on the first image.
- The last image is displayed in auto review.
- The number of continuous shooting images obtainable has an upper limit.

The maximum number of continuous shots

RAW	18 images
cRAW	25 images
RAW & JPEG	12 images
cRAW & JPEG	12 images
Extra fine	16 images
Fine/Standard	No limit (Until the memory card is full)

- These numbers depend on the writing speed of a memory card, the shooting condition, etc. So, use the table only as a guide.

Using the self-timer

After you press the shutter button, the shutter will be released either about ten seconds or two seconds later. The 10-second self-timer is convenient when the photographer appears in a photo and the 2-second self-timer is convenient to reduce the camera-shake because the mirror is pulled up beforehand.

Check that the focus is confirmed on the subject, then press the shutter button.

 10 10sec self-timer

 2 2sec self-timer

- When using the 10-second self-timer, the self-timer lamp located on the front side flashes before the shutter is released. The countdown sound also starts.
- To cancel the activated 10-second self-timer, press the DRIVE button. You cannot cancel the 2-second self-timer in the middle.
- When there is bright lighting, a reflector or something similar behind the camera, and you press the shutter button without looking into the viewfinder, use the eyepiece cover attached on the shoulder strap to prevent unnecessary lighting from seeping through the viewfinder and affecting the exposure (page 44).

Shooting images with the exposure shifted – Bracket: Cont./Bracket: Single

An accurate exposure setting is required for some shooting. In such cases, a photographer continuously shoots some images with the exposure shifted, aside from the correct exposure image.



Correct

– direction

+ direction

Bracket: Cont.

Press and hold the shutter button until the recording stops.



0.3e/3

Shoots three images continuously with the exposure shifted by 0.3 of a step.



0.3e/5

Shoots five images continuously with the exposure shifted by 0.3 of a step.



0.5e/3

Shoots three images continuously with the exposure shifted by 0.5 of a step.



0.5e/5

Shoots five images continuously with the exposure shifted by 0.5 of a step.



0.7e/3

Shoots three images continuously with the exposure shifted by 0.7 of a step.









0.7e/5

Shoots five images continuously with the exposure shifted by 0.7 of a step.

Bracket: Single



Press the shutter button shot by shot.

-  Shoots three images shot by shot with the exposure shifted by 0.3 of a step.
-  Shoots five images shot by shot with the exposure shifted by 0.3 of a step.
-  Shoots three images shot by shot with the exposure shifted by 0.5 of a step.
-  Shoots five images shot by shot with the exposure shifted by 0.5 of a step.
-  Shoots three images shot by shot with the exposure shifted by 0.7 of a step.
-  Shoots five images shot by shot with the exposure shifted by 0.7 of a step.

- When using the flash, press the shutter button shot by shot regardless of the setting.
 - The following is an example of shooting order. You can change the order with [Bracket order] in the  Custom menu (page 111).
Three shots : 0 → -0.3 → +0.3
Five shots : 0 → -0.5 → +0.5 → -1.0 → +1.0
 - The base exposure is set at the first shot in the bracket. The base exposure moves if exposure compensation is used.
 - Normally, the focal point changes in every shooting. The focal point is fixed only in continuous bracket shooting when the focus mode is set to Single-shot AF or Automatic AF with an still subject.
 - When the flash is not used, ambient* bracket shooting is performed and the shutter speed and aperture are changed to accommodate bracket shooting. When the flash is used, flash bracket shooting is performed and the flash light is changed.
 - In ambient bracket shooting, the shutter speed and aperture change in program auto mode, the shutter speed changes in aperture priority mode, and aperture changes in shutter speed priority mode. Normally, the shutter speed changes in manual mode. You can change the aperture by pressing and holding the AEL (AE Lock) button while taking a picture.
- * Ambient light: Any light other than the flash light that shines on the scene for an extended period of time, such as natural light, a light bulb, or a fluorescent light.

The EV scale in bracket shooting

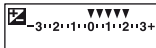
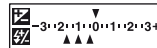
When bracket shooting is selected, the EV scale is changed.

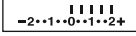
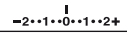
	Ambient bracket 0.3 steps, three shots Exposure compensation 0	Ambient bracket 0.5 steps, five shots Exposure compensation 1.0	Flash bracket 0.7 steps, three shots Flash compensation -1.0
LCD monitor			
	Shown in the top row.	Shown in the top row.	Shown in the bottom row.
Viewfinder			

- In ambient bracket shooting, the EV scale appears in the viewfinder, too, but it does not appear in flash bracket shooting.

- When the bracket shooting starts, the indexes that indicate already recorded images start to disappear one by one.
- When Single bracket is selected, if the shutter button is pressed halfway down and released, “br 1” appears for the ambient light bracket and “Fbr 1” appears for the flash bracket in the viewfinder. When bracket shooting starts, it indicates what number the next frame is, for instance, “br 2”, “br 3”.

Shooting with the WB bracket

Based on the selected white balance, three pictures are taken while automatically shifting the color temperature. One shot records three images in the order of “an image with normal white balance”, “- side (an image with paler colors)”, and “+ side (an image with reddish colors)”.

 Shifts the white balance by 10 mired* when taking a picture.

 Shifts the white balance by 20 mired* when taking a picture.

* Mired: a unit to indicate the color conversion quality in color temperature filters.

- Only the image recorded last is displayed in auto review (page 111).

Shooting with the DRO advanced bracket

DRO advanced bracket shooting takes three pictures while separately optimizing the gradation and colors in each image area. One shot records three images in the following order: “low” → “mid” → “high”.

(DRO: D-Range Optimizer)

 Lowers the DRO bracket when taking a picture.

 Amplifies the DRO bracket when taking a picture.

- When DRO advanced bracket shooting is selected, the D-Range Optimizer setting (page 66) is temporarily deactivated.
- Correction with DRO advanced bracket has no effect on RAW files.

Shooting with the Remote Commander

To shoot with the Remote Commander, set the drive mode to  (Remote Commander).

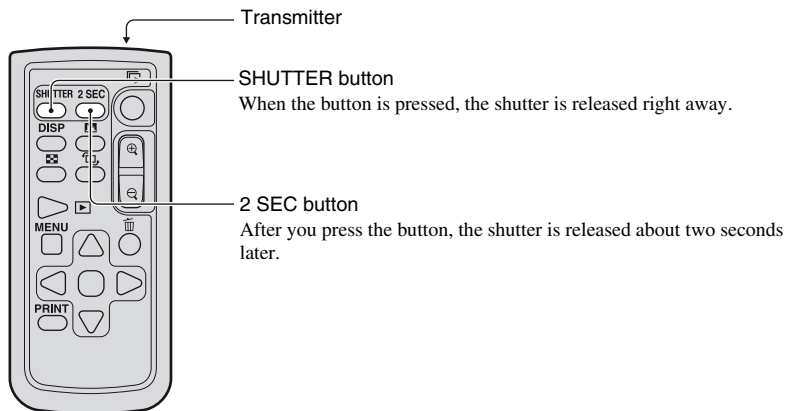

Verify that the subject is visually in focus, and point the transmitter at the remote sensor located on the front of the camera, then press the SHUTTER or 2 SEC button.

- You cannot use the other drive modes (Continuous advanced, etc.).
- To lock the focus (focus lock shooting, page 51), press the shutter button on the camera halfway down and release the button, then shoot with the Remote Commander. After shooting, the focus remains locked. Any operation on the camera will release the focus lock.
- In BULB shooting (page 43), the camera starts exposure right away when you press the SHUTTER button, and the camera starts exposure two seconds later when you press the 2 SEC button. By pressing the SHUTTER or 2 SEC button again, the exposure will be done right away.
- The other buttons are used when the camera is connected to a TV (pages 91, 148).





Image processing and color

This section explains how to set up the ISO sensitivity of the image sensor, color processing that is a unique feature of digital cameras, Creative Style for various scenes, etc.

Adjusting the white balance

The color of the subject is affected by the lighting conditions.

Example: The color of an image affected by light sources

Weather/lighting	Daylight	Cloudy	Fluorescent	Incandescent
				
Characteristics of light	White (standard)	Bluish	Green-tinged	Reddish

The color tones are adjusted automatically in the auto white balance mode. However, you can adjust color tones manually with the white balance mode.

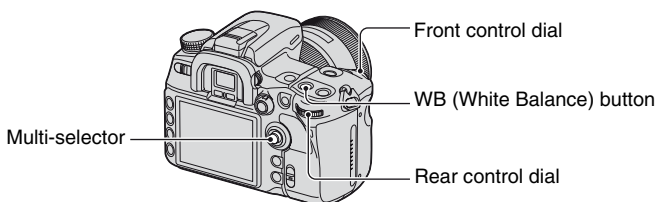

- 1 Press the WB (White Balance) button to display the White balance mode screen.

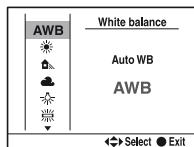

② Select the desired mode with ▲/▼ on the multi-selector, then make fine adjustments with ◀/▶, if necessary.

- Adjusting toward + increases the color temperature and the image turns reddish. Adjusting toward - decreases the color temperature and the image turns paler.

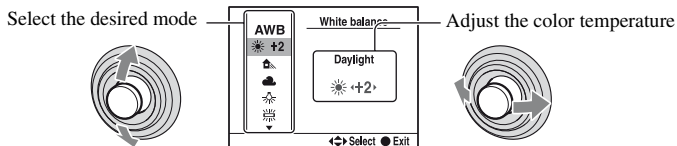

(✔ : The default setting)

✔	AWB (Auto WB)	Adjusts the white balance automatically.
☀	(Daylight)	Adjusts for outdoors, sunlit subjects (+3 to -3).
🏠	(Shade)	Adjusts for shady conditions on a clear day (+3 to -3).
☁	(Cloudy)	Adjusts for a cloudy sky (+3 to -3).
💡	(Tungsten)	Adjusts for incandescent lighting or video light such as at photography studios (+3 to -3).
⚡	(Fluorescent)	Adjusts for fluorescent lighting (+4 to -2).
📷	(Flash)	Adjusts for flash condition (+3 to -3).
	ColorTemperature/Color filter	See the following page.
📧	(Custom 1 - 3/Custom setup)	Uses the custom white balance. See page 63.

- You can substitute the Fn (Function) button for the WB (White Balance) button (page 30).

ColorTemperature/Color filter

You can set the white balance using a color temperature.

Based on using the set color temperature as the standard, the color can be compensated from G (Green) to M (Magenta) just like using a CC (Color Compensation) filter for photography.

- When setting the color temperature measured by the color meter, test shooting is recommended before the actual photo is taken.

- ① Select a “ColorTemperature” or “Color filter” item with ▲/▼ on the multi-selector.

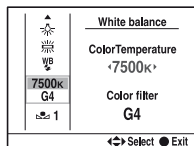

- ② Adjust with ◀/▶.
 - The color temperature can be selected between 2500K and 9900K.
 - The color filter value can be selected between G9 and M9. The increment is equivalent to the CC filter number 5.
- ③ Press the center of the multi-selector after the setting is completed.

Custom white balance

In a scene where the ambient light consists of multiple types of light source, use of custom white balance is recommended in order to accurately reproduce the whiteness. Up to three settings are registered.

- ① Select a custom white balance item with ▲/▼ on the multi-selector.
- ② Switch the item with ◀/▶.

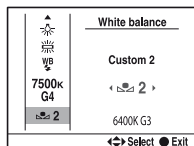

To register a setting

- ① Select [📷 SET], then press the center of the multi-selector to display the register screen.



- ② Hold the camera so that the white area fully covers the spot-metering circle and press the shutter button down.

The register selection screen appears.

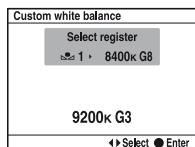

- ③ Select a memory number with $\blacktriangleleft/\blacktriangleright$, then press the center.

To call the custom white balance setting

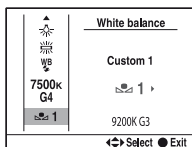

Select the desired number.

- The custom white balance setting registered in this operation is effective until a new setting is registered. (The setting is retained after the power is turned off.)
- If the flash is used when the shutter button is pressed, a custom white balance is registered with the flash light taken into account. Take pictures with the flash in later shootings.
- The message “Custom WB error” indicates that the value is beyond the expected range. (When the flash is used on a subject in close proximity or a subject with a bright color is in the frame.) If you register this value, the  indicator turns yellow on the recording information display on the LCD monitor. You can shoot at this point, but it is recommended that you set the white balance again to get a more correct white balance value.

Setting ISO

Sensitivity to light is expressed by the ISO number (recommended exposure index). The larger the number from the standard (ISO 200), the higher the sensitivity.

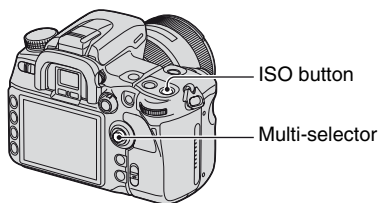

- ① Press the ISO button to display the ISO screen.

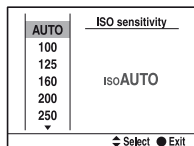

- ② Select the desired value with ▲/▼ on the multi-selector.
- ISO can be set from [AUTO] and between 100 and 6400.
 - ISO numbers that are higher than ISO 3200 increase the appearance of noise.
 - You can use the front or rear control dial instead. The number is incremented by 1 step using the front control dial and it is incremented by 1/3 step using the rear control dial.
 - You can substitute the Fn (Function) button for the ISO button (page 30). As in this case above, the number is incremented by 1 step using the front control dial and it is incremented by 1/3 step using the rear control dial.
 - When ISO is set to [AUTO] and the mode dial is set to P, A, or S, the ISO sensitivity is automatically adjusted between ISO 200 and ISO 800. You can change the maximum and minimum values with [ISO Auto max.] and [ISO Auto min.] in the Recording menu (page 100). If the mode dial is set to M, it is fixed at ISO 200.
 - The built-in flash range (the range within which the correct exposure is provided) depends on the aperture value and ISO sensitivity. Refer to the following table to determine the shooting distance.

Aperture		F2.8	F4.0	F5.6
ISO setting	AUTO	2 – 12 m (6.6 – 40 feet)	1.4 – 8.6 m (4.6 – 28 feet)	1 – 6 m (3.3 – 20 feet)
	100	1 – 4.3 m (3.3 – 14 feet)	1 – 3 m (3.3 – 10 feet)	1 – 2.1 m (3.3 – 7 feet)
	200	1 – 6 m (3.3 – 20 feet)	1 – 4.3 m (3.3 – 14 feet)	1 – 3 m (3.3 – 10 feet)
	400	1.4 – 8.6 m (4.6 – 28 feet)	1 – 6 m (3.3 – 20 feet)	1 – 4.3 m (3.3 – 14 feet)
	800	2 – 12 m (6.6 – 40 feet)	1.4 – 8.6 m (4.6 – 28 feet)	1 – 6 m (3.3 – 20 feet)
	1600	2.8 – 17 m (9 – 56 feet)	2 – 12 m (6.6 – 40 feet)	1.4 – 8.6 m (4.6 – 28 feet)
	3200	4 – 24 m (13 – 79 feet)	2.8 – 17 m (9 – 56 feet)	2 – 12 m (6.6 – 40 feet)
	6400	5.6 – 34 m (18 – 112 feet)	4 – 24 m (13 – 79 feet)	2.8 – 17 m (9 – 56 feet)

Using the D-Range Optimizer

The camera analyzes the shooting conditions and automatically corrects the image to improve the image quality.

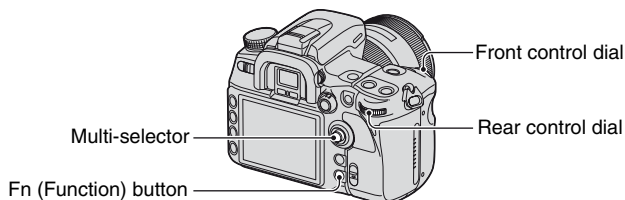

- ① Press the Fn (Function) button to display the Quick Navi screen (page 30).
- ② Select the D-Range Optimizer item with the multi-selector.

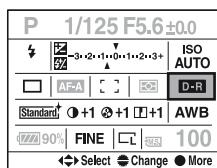

- ③ Select the desired mode with the front control dial.
 - When selecting Advanced: Level, adjust the level with the rear control dial.
- After selecting the D-Range Optimizer item in step ②, if you press the center of the multi-selector, the screen switches to the Exclusive disp screen. On this screen, select the desired mode with ▲/▼ on the multi-selector, then press the center. When in Advanced: Level, adjust the level with ◀/▶.
- You can also switch the screen to the Exclusive disp screen from the Recording menu (page 97).

Off (Off)	Does not correct brightness or contrast.
(Standard)	Adjusts the brightness and contrast of the whole screen.
(Advanced Auto)	Automatically, optimizes the contrast and the color reproduction of the recorded image by area.
(Advanced: Level) Lv 1 – Lv 5	Optimizes the contrast and the color reproduction of the recorded image by area. The optimizing level is selected between Lv 1 (weak) and Lv 5 (strong) in five levels.

- Standard is effective when the screen is wholly dark such as with a backlit subject and Advanced is effective when the difference between the bright and dark portions on the screen is extremely large.

- The default setting is as follows:
 - In auto adjustment mode: Advanced Auto
 - In program auto, aperture priority, shutter speed priority, or manual exposure mode: Standard
 - In Scene Selection mode: Unfixed, depending on the selected mode
- When using AE lock, the camera automatically corrects the locked image.
- When in Continuous advance mode, the correction is fixed onto the first image, the same correction is used for the second or later images.
- D-Range Optimizer other than **DR** (Standard) has no effect on RAW files. Correct images using the D-Range Optimizer function of “Image Data Converter SR.”
- When DRO advanced bracket shooting is selected, the setting here is temporarily deactivated.

Using a Creative Style

This camera is pre-programmed with image styles optimal for various scenes and purposes. You can take a picture with an appropriate color balance and tone.

The camera is equipped with four unswitchable styles (“Standard”, “Vivid”, “Neutral”, and “Adobe RGB”) and three styleboxes, to which you can assign image styles of your choosing. “Portrait”, “Landscape”, and “B/W” are assigned to the styleboxes as the default settings. To take pictures with the styleboxes as they are. → See “Basic operation” (page 69).

To take pictures with an image style (see “Image styles”, (page 68)) assigned to the stylebox. → See “Advanced operation” (page 70).

- If the Scene Selection is used, you cannot change the settings for the Creative Style.

You can adjust the contrast for each image style separately. The switchable image styles and unswitchable ones have different items that can be adjusted.

Unswitchable image styles:
 “Standard”, “Vivid”, “Neutral”, and
 “Adobe RGB”

Switchable image styles: Stylebox
1 – **3**

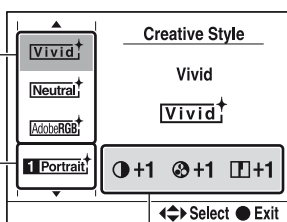

Adjustable Items

Item	Contrast	Saturation	Sharpness	Brightness	Zone Matching
Unswitchable image styles	-3 to +3	-3 to +3	-3 to +3	not adjustable	not adjustable
Switchable image styles	-3 to +3	-3 to +3*	-3 to +3	-3 to +3	-1 to +2

* When “B/W” or “Sepia” is selected, you cannot adjust the saturation.

- These adjustments are not always necessary. You can make an adjustment for each image style. (If one style is in multiple styleboxes, separate adjustments can be made on each of them.)
- When you need to adjust contrast, saturation, and sharpness before other items, select “Standard” image style to make the adjustments.

Image styles

(✓: The default setting)

✓	Standard (Standard)	For capturing various scenes with rich gradation and beautiful colors.
	Vivid (Vivid)	The saturation and contrast are heightened for capturing striking images of colorful scenes and subjects such as flowers, spring greenery, blue sky, or ocean views.
	Neutral (Neutral)	The saturation and sharpness are lowered for capturing images in a quiet tone. This is also suitable for capturing image material to be modified with a computer.
	AdobeRGB (Adobe RGB)	For capturing images in Adobe RGB color space.
	Clear (Clear)	For capturing images in a clear tone with limpid colors in the highlighted area, suitable for capturing radiant light.
	Deep (Deep)	For capturing images with deep and dense color expressions, suited to capturing the solid presence of the subject.
	Light (Light)	For capturing images with bright and uncomplicated color expressions, suited to capturing refreshingly light ambience.

Portrait † (Portrait)	For capturing the skin color in a soft tone, ideally suited to capturing portraits.
Landscape † (Landscape)	The saturation, contrast, and sharpness are heightened for capturing vivid and crisp scenery. Distant landscapes also stand out more.
Sunset † (Sunset)	For capturing the beautiful red of the setting sun.
Night † (Night view)	The contrast is attenuated for capturing a nightscape that is more faithful to the real view.
Autumn † (Autumn leaves)	For capturing autumn scenes, vividly highlighting the red and yellow of coloring leaves.
B/W † (B/W)	For capturing images in black and white monotone.
Sepia † (Sepia)	For capturing images in sepia monotone.

Basic operation

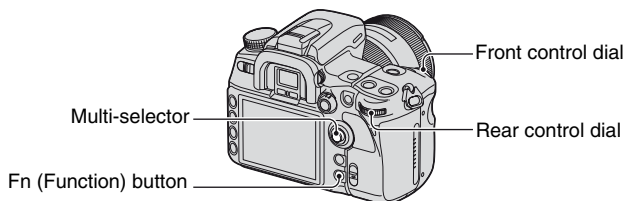

- Press the Fn (Function) button to display the Quick Navi screen (page 30).
 - When the enlarged display screen is used (page 23), you cannot display the Quick Navi screen. In this case, set up from the menu.
- Select a Creative Style item with the multi-selector.

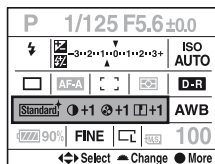

- If you do not make adjustments on contrast, etc., you can make other settings from this menu using the front or rear control dial.

- ③ Press the center to display the Creative Style screen.

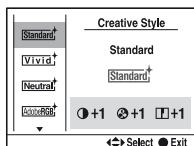

- You can select this screen from the Recording menu (page 97).

- ④ Select the desired image style with / on the multi-selector.

- You can select “Standard”, “Vivid”, “Neutral”, “Adobe RGB”, “Portrait”, “Landscape”, and “B/W” with the default setting. To select other image styles, see “Advanced operation” (below).

- ⑤ To adjust (Contrast), (Saturation), and (Sharpness), select the item with / and make adjustments with /.

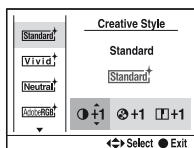

- ⑥ Press the center of the multi-selector after the setting is completed.

Advanced operation

Of the seven image styles explained in “Basic operation”, the last three styles are Styleboxes 1 – 3, which can be switched.

Example: When you have assigned “Standard” to one stylebox and “Landscape” to two styleboxes.

Unswitchable	Standard	Saturation, contrast, and sharpness can be adjusted.
	Vivid	
	Neutral	
	Adobe RGB	
Switchable	Standard	Brightness and Zone Matching can be adjusted, in addition to saturation, contrast, and sharpness. Different adjustments can be set for each “Landscape”.
	Landscape	
	Landscape	

To switch image styles for the stylebox

- ① Display the Creative Style screen (steps ① to ③ on page 69).

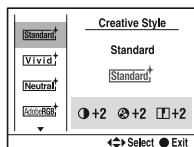

- ② Select a switchable stylebox with ▲/▼ on the multi-selector.
 ③ Move the cursor to the right side with ►, and select an image style with ▲/▼.

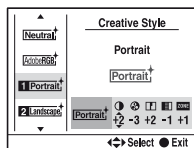

- ④ To adjust ◐ (Contrast), ⊗ (Saturation), □ (Sharpness), ▒ (Brightness), and ZONE (Zone Matching), select an item with ◀/▶ and make adjustments with ▲/▼.
 ⑤ Press the center of the multi-selector after the setting is completed.

Zone Matching

Image styles in the switchable style boxes can adjust the Zone Matching.

You can keep the image from becoming overexposed or underexposed.

This function is also available for a RAW file.

-1	This keeps the image from becoming underexposed with shooting a high-keyed subject. Use in low-key (predominantly dark) scenes is recommended, as the image tends to become whitish.
0	Zone Matching is not performed.
+1 to +2	This keeps the image from becoming overexposed with shooting a low-keyed subject. Use in high-key (predominantly light) scenes is recommended, as the image tends to have heightened noise level.

- When Zone Matching is not set to 0, the contrast cannot be adjusted.
- Refer to the following table to determine the flash range.

(At ISO 100)

Aperture		F2.8	F4.0	F5.6
Zone Matching	-1	1.7 – 10 m (5.6 – 33 feet)	1.2 – 7 m (3.9 – 23 feet)	1 – 5 m (3.3 – 17 feet)
	+1	2.4 – 14 m (7.9 – 46 feet)	1.7 – 10 m (5.6 – 33 feet)	1.2 – 7 m (3.9 – 23 feet)
	+2	2.8 – 17 m (9 – 56 feet)	2 – 12 m (6.6 – 40 feet)	1.4 – 8.6 m (4.6 – 28 feet)

About Adobe RGB color space

Adobe RGB color space has a wide range of color reproduction, compared to sRGB that is the standard color space of the digital camera. If the main purpose is to print out the image, especially when a large part of the subject is vivid green or red, Adobe RGB is more effective than other sRGB color modes.

- The file name of the image starts with “_DSC”.

About color matching in Adobe RGB

When displaying images that were recorded with Adobe RGB on non-Adobe RGB-compliant devices, or on the LCD monitor on the rear of the camera, images are displayed with low saturation. To edit or print images recorded with Adobe RGB, use applications or printers that support color management and DCF2.0 option color space. Using some applications and printers that do not support color management may result in or print images that do not reproduce faithful color.

Flash

This section explains the various shooting functions with the flash.

Selecting the flash mode

If the built-in flash is pulled up, the flash fires automatically when the surroundings are dark in auto adjustment or Scene Selection mode. You can intentionally change the flash mode.

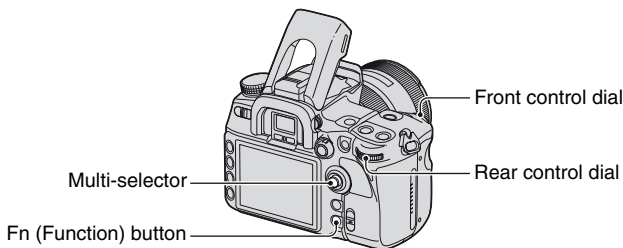

- ① Press the Fn (Function) button to display the Quick Navi screen (page 30).
 - When the enlarged display screen is used (page 23), you cannot display the Quick Navi screen. In this case, set up from the menu.
- ② Select a Flash item with the multi-selector.

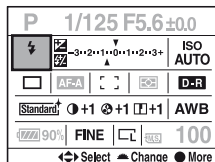



- ③ Select the desired mode with the front or rear control dial.
 - The flash indicator is displayed only when the flash is pulled up.
 - After selecting the flash item in step ②, if you press the center of the multi-selector, the screen switches to the Exclusive disp screen. On this screen, select the desired mode with ▲/▼ on the multi-selector, then press the center.
 - You can also select the flash mode from the Recording menu (page 99).

(✓: The default setting)

✓	AUTO (Autoflash)	Fires if it is dark or against light. <ul style="list-style-type: none">• This is not selectable when the mode dial is set to P, A, S, or M.
	⚡ (Fill-flash)	Fires whenever the built-in flash is pulled up.

<p>REAR (Rear sync.)</p>	<p>Ordinarily, the flash is fired right after the shutter has been released, then objects illuminated by other light sources are captured. This causes certain subjects, such as trailing light, to appear unnatural when the slower shutter speed is used. In rear sync mode, the objects illuminated by other light sources are captured first, then the flash is fired. You can capture a flowing light or the trail of a moving subject in a more realistic way when shooting a moving subject using a slower shutter speed with the flash.</p> 
<p>WL (Wireless)</p>	<p>Using an external flash (not supplied) mounted on the camera may make certain pictures appear too flat. In such a case, an off-camera flash in a proper position can create more contrast, resulting in a more three-dimensional picture. This camera can do this shooting without a cable using the flash light to transmit the signal between the camera and the flash (Wireless flash shooting).</p> <ul style="list-style-type: none"> • Wireless flash shooting requires the flash HVL-F56AM or HVL-F36AM (not supplied).

To perform wireless flash shooting

- ① Attach the external flash to the camera (page 166) and turn on the camera and the external flash.
 - ② Select **WL** (Wireless).
 - ③ Remove the external flash from the camera and pull up the built-in flash on the camera. “WL” appears in the viewfinder and on the LCD monitor.
 - ④ Determine the position of the camera and the external flash.
 - ⑤ Make sure the built-in flash and the external flash are fully charged.
 - The built-in flash is fully charged when  appears in the viewfinder.
 - The external flash is fully charged when  appears on the back of the external flash and the red lamp flashes on the front of the flash.
 - ⑥ Press the AEL (AE Lock) button on the camera to test fire the flash.
 - If the flash does not fire, change the camera, external flash, or subject position.
 - ⑦ Check both flashes again to make sure they are fully charged. Press the shutter button to take a picture.
- Turn off the wireless flash mode after wireless flash shooting. (You can either deactivate the camera and the external flash separately, or you can attach the external flash to the camera and select a different flash mode, as shown on page 73). If the built-in flash is used while the wireless flash mode is still active, inaccurate flash exposures will result.
 - You can select the wireless setting on the camera and the external flash separately. See page 73 to set the camera. To set the external flash, refer to the operating instructions supplied with it.

If the operation and the function of the AEL (AE Lock) button have been changed

When using the wireless flash, it is recommended that you set [AEL button] (page 107) to [AEL hold] or [AEL hold] in the Custom menu.

If you select a setting that is retained after the button has been released ([AEL toggle]/[AEL toggle]) the camera is in slow sync recording mode while “AEL” appears in the viewfinder and on the LCD monitor. Every test fire will cause the slow sync recording mode to switch on and off.

About the position of the camera and the flash

This camera uses the flash light of its built-in flash to send a signal to the off-camera flash to fire. Take note of the following points to ensure proper transmission of the signal.

- Wireless flash shooting should be performed in a dark environment such as indoors, etc.
- We recommend that you place the camera and the external flash in the gray area within radius 5 m (16.4 ft) as illustrated below. For more information about flash range, also refer to the operating instructions supplied with your flash.
- Do not place the external flash directly behind the subject.

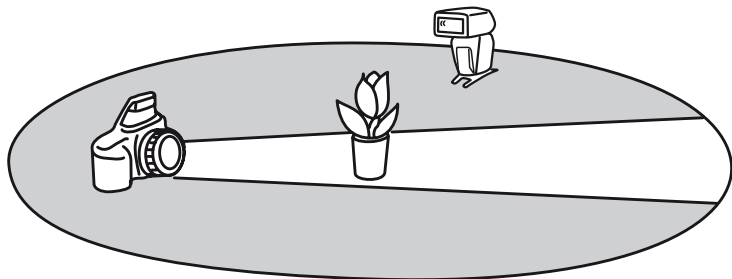

💡 About the wireless flash channels

Change the channel of the external flash when another photographer is using a wireless flash nearby and his/her built-in flash light triggers firing of your flash.

To change the channel of the external flash, refer to the operating instructions supplied with it.

Using the flash compensation

When shooting with the flash, you can adjust the amount of flash light alone, without changing the exposure compensation. You can change the exposure of a subject which is within the flash range, while leaving the exposure of the background, which is out of the flash range, as it is.

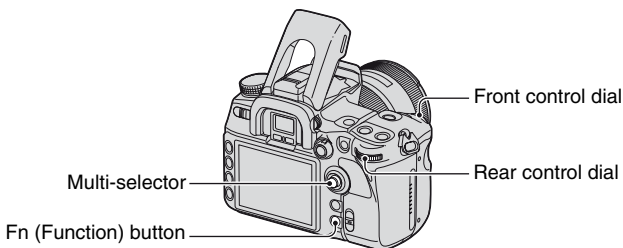

- ① Press the Fn (Function) button to display the Quick Navi screen (page 30).
- ② Select the flash compensation item with the multi-selector.

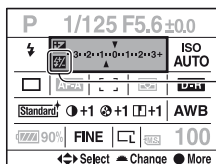

- ③ Select the desired value with the front or rear control dial.
- When the Exclusive disp screen is displayed in step ②, select the desired value with ◀▶ on the multi-selector.
 - You can also select the Exclusive disp screen from the 📷 Recording menu (page 100).
 - You can set the degree of compensation in 1/3 increments within ± 3.0 . You can set this exposure step to 1/2 EV increments with [Exposure step] in the 📷 Recording menu (page 98).
 - When the built-in flash is pulled up, the set flash compensation value is displayed on the LCD monitor.
 - When you press the shutter button halfway down, $\frac{F}{2}$ appears in the viewfinder.
 - When performing flash compensation with the built-in flash, the positive effect may not be visible due to the limited amount of flash light, if the subject is at or around the maximum range for the flash. If the subject is very close, the negative effect may not be visible.

🔦 Exposure compensation and flash compensation

Exposure compensation changes the shutter speed, aperture, and ISO sensitivity (when [AUTO] is selected) to perform the compensation. If the flash is used, the amount of flash light is also changed*.

On the other hand, flash compensation only changes the amount of flash light, thereby controlling the relative effect of the flash light on the whole picture. For instance, if you want to reduce the flash light, you can set the flash compensation on the slightly negative side and at the same time set the exposure compensation on the positive side to adjust the brightness of the entire picture.

* You can keep the amount of flash light from changing with the exposure compensation with [Exp.comp.set] in the ⚙ Custom menu (page 110).

Shooting with Slow Sync (Shooting the dark background with flash)

When you shoot a portrait outdoors at night with a dark background, a normal use of flash will capture a clear image of the subject, but the background is out of flash range and will be too dark. In such a case, slow sync shooting (shooting with the flash and a slow shutter speed) allows you to capture a clear image of both the subject and the background.

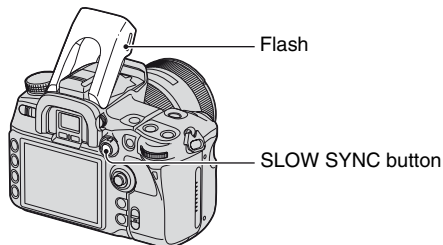

- ① Pull up the built-in flash.
 - ② Shoot with the SLOW SYNC button pressed.
 - * in the viewfinder and on the LCD monitor lights up to indicate the exposure is locked.
- Use of a tripod is recommended because of the slower shutter speed.
 - In shutter speed priority mode or manual mode, slow sync shooting is not available using the AEL (AE lock) button.
 - You can set the camera to keep the slow sync mode after the SLOW SYNC button is released with [AEL button] in the ⚙ Custom menu (page 107).

Using the flash sync terminal

You can use a flash equipped with a flash sync cord.

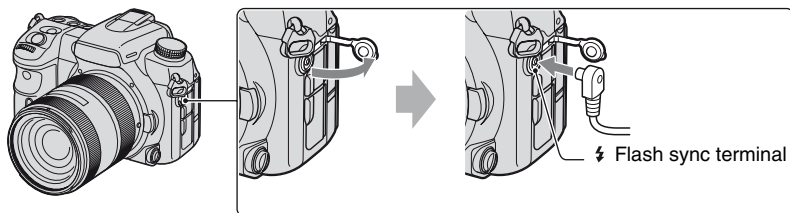

Open the cover of the flash sync terminal and plug the cord in.

- Select the manual exposure mode and set the shutter speed to 1/200 second with the Super SteadyShot on or 1/250 second with the Super SteadyShot off. If the shutter speed recommended on the flash is slower than that, use the recommended speed or an even slower speed.
- Use a flash with a flash sync voltage of 400V or less.

- Before you connect the flash sync cord to the  Flash sync terminal, turn off the power of the connected flash. If the power is on, it may flash when you connect the cord.
- The flash will always be full emission. Flash compensation (page 75) cannot be used. You can perform bracket shooting while holding down the AEL (AE lock) button (the aperture is adjusted, page 46).
- Using auto white balance is not recommended. Use custom white balance to gain more precise white balance.
- You can use a flash equipped with a flash sync terminal of the opposite polarity.

Other operations

Registering your own settings

You can register a combination of frequently used modes and settings in the memory. You can recall the registered settings by selecting “MR” on the mode dial.

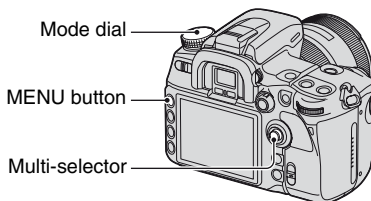

To register a setting

- ① Put the camera on the setting you want to register. See the next page for the items that can be registered.
 - The items to be registered include all the functions and recording menus with exclusive buttons and levers. You cannot register only some of the items.
- ② Press the MENU button to display the menu screen.
- ③ Select Recording menu → [4] → [Memory] with the multi-selector (page 32).

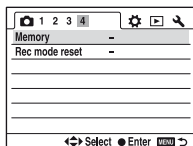

- ④ Press the center of the multi-selector to display the Select register screen. The memory information set in step ① (the current setting on the camera) will be displayed.

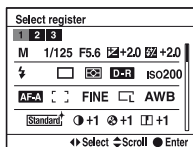

- ⑤ Select the number you want to register with , then press the center.
 - You can register up to three settings.
 - You can rewrite the settings as many times as you like.

Items that can be registered

Page numbers in parentheses

Recording mode ¹⁾ (34)	Drive mode (55)	ISO sensitivity (64)
White Balance ²⁾ (61)	Exposure comp. (45)	Metering mode (48)
Focus mode (52)	Image size (94)	Aspect ratio (95)
Image quality (96)	D-Range Optimizer (66)	Creative Style ³⁾ (67)
Custom button (81)	Exposure step (98)	Flash mode (73)
Flash control (99)	Power ratio (100)	Flash compens. (75)
ISO Auto max. (100)	ISO Auto min. (100)	AF-A setup (101)
AF area (49)	AF area position (49)	Priority setup (102)
AF illuminator (54)	AF w/ shutter (102)	Long exp.NR (103)
High ISO NR (103)		

¹⁾When the mode dial is set to A, the aperture value is also registered, when set to S, the shutter speed value is also registered, and when set to M, the aperture and shutter speed values are also registered. Program shift and manual shift cannot be registered.

²⁾The number and the settings will be registered with the custom white balance.

³⁾Contrast, saturation, sharpness, brightness, and Zone Matching will be registered at the same time.

To recall the saved settings

- ① Set the mode dial to MR to display the Memory recall screen.
- ② Select the number to be recalled with ◀/▶ on the multi-selector, and press the center.

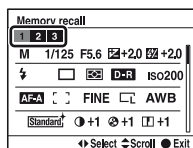

- After you have recalled a setting, the actual setting will not correspond to the positions of the dials and levers on the camera. Refer to the information displayed on the LCD monitor when you take pictures.
- You can change the settings after you have recalled a saved setting. A new setting can be registered by following the steps in “To register a setting”.

Using the C (Custom) button

You can assign a function of your choosing to the C (Custom) button. Press the button and the setting screen of the selected function is displayed.

Creative Style (page 67) is assigned to the C button as the default setting.

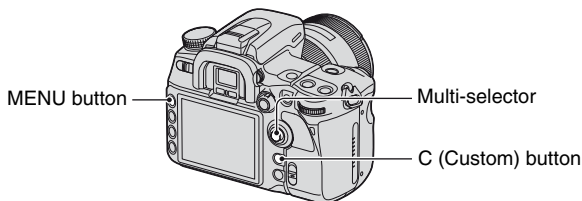

To assign a function

- Press the MENU button to display the menu screen.
- Select Recording menu → [1] → [Custom button] with the multi-selector (page 32).

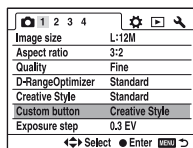

- Press the center of the multi-selector.

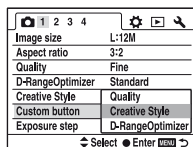

- Select the item to be assigned with ▲/▼ and press the center.

(✓ : The default setting)

AF lock	Functions as the AF lock button (page 105).
AF/MF control	Functions as the AF/MF button (page 53).
D.O.F.preview	Functions as the Depth-of-field preview button (page 39).
ISO	Functions as the ISO button (page 64).
White balance	Functions as the white balance button (page 61).
Exposure comp.	Functions as the exposure button (page 45).

	Flash compens.	Displays the flash compensation setup screen (page 75).
	Drive mode	Functions as the DRIVE button (page 55).
	AF area	Displays the AF area setup screen (page 49).
	Image size	Displays the image size setup screen (page 94).
	Quality	Displays the image quality setup screen (page 96).
✓	Creative Style	Displays the Creative Style setup screen (page 67).
	D-RangeOptimizer	Displays the D-Range Optimizer setup screen (page 66).
	Flash mode	Displays the flash mode screen (page 73).
	Memory	Displays the register setup screen (page 79).

To use the assigned function

Press the C (Custom) button.

The assigned function is activated or its menu screen is displayed.

Viewing images

Pressing the  (Playback) button turns the camera to the playback mode and an image is displayed on the LCD monitor.

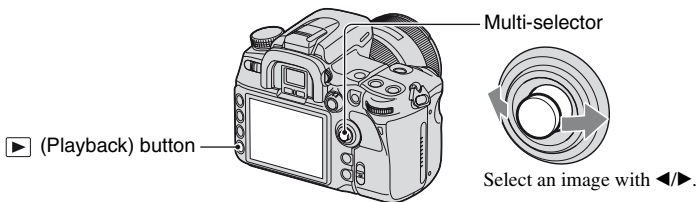

Switching the playback screen

During playback, each time you press the DISP (Display) button, the screen changes as follows.

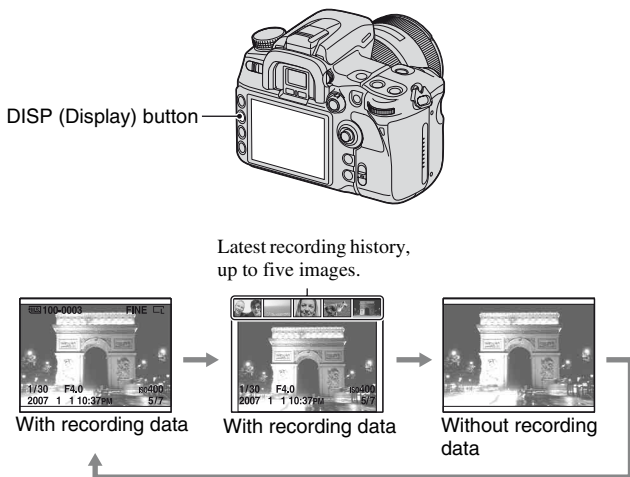

- The DISP (Display) button switches the recording data display on and off in other playback modes, such as on an enlarged screen.

Switching to the index screen

Pressing the  (Index) button switches to the index screen. Each time you press the DISP (Display) button, the screen changes as follows.

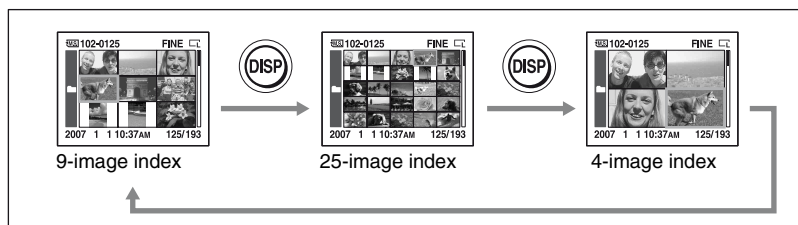
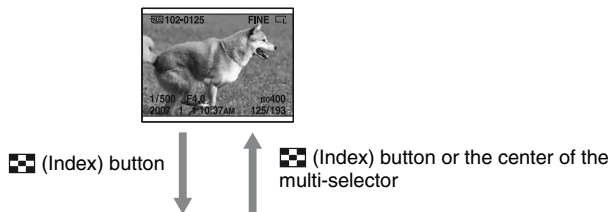
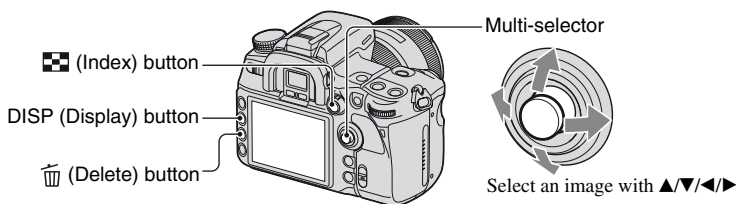

Rotating the rear dial switches the index images screen-by-screen. This is convenient when you want to switch to the next screen quickly.

To select the folder

- 1 Select the folder bar with ◀/▶ on the multi-selector, then press the center.

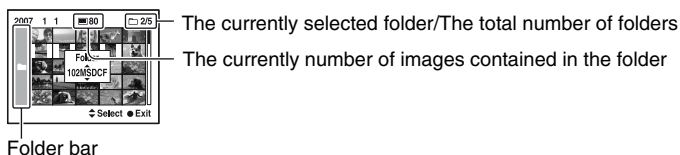

- ② Select the desired folder with ▲/▼, then press the center.

To delete all the images in the folder

- ① Select the folder you want to delete with ▲/▼ on the multi-selector.
 ② Press the  (Delete) button.

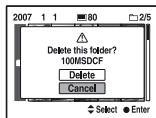

- ③ Select “Delete” with ▲, then press the center.
- You can set the confirmation screen to [Delete], as previously selected with [Delete confirm.] in the  Setup menu (page 125).
 - When you want to delete selected images, see page 114.
 - Once you have deleted an image, you cannot restore it.
 - Protected images cannot be deleted.

Displaying the histogram

Pressing the  (Histogram) button displays the histogram and recording data of the displayed image. Pressing it again turns the screen to a previous screen.

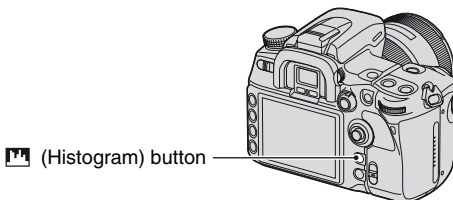

When the image has a high-key or low-key portion, that portion is illuminated on the histogram display (Luminance limit warning).

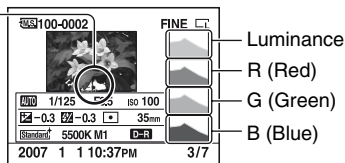

About Histogram

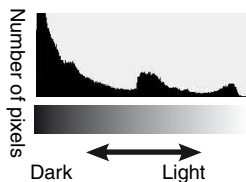

A histogram is the luminance distribution that shows how many pixels of a particular brightness exist in the picture. This camera has four histogram displays that are separately for luminance and RGB, and each shows the brightness on the horizontal axis (left side is black, right side is white) and the number of pixels on the vertical axis. The exposure compensation will change the histogram accordingly. Below is an example.



Use the exposure compensation on the positive side.



This compensation brightens the whole picture, making the entire histogram shift to the bright side (right side). If the exposure compensation is applied on the negative side, the histogram will shift to the other side.



Both ends of the histogram consist only of data of 100% black or white*. Checking the histogram allows you to know the status of the image beforehand.

* To be exact, a color image is expressed with RGB. Thus, the white is equal to R255, G255, B255, and the black is equal to R0, G0, B0.

Enlarging images

An image can be enlarged for closer examination.

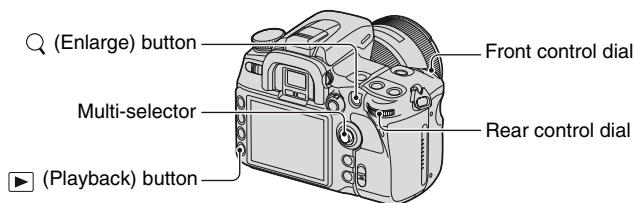

- ① Display the image you want to enlarge, then press the **Q** (Enlarge) button.
The center of the image is enlarged.

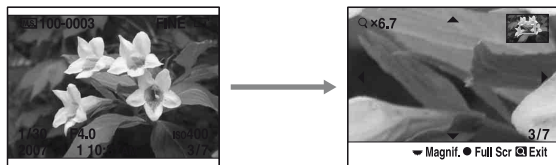

- ② Scale up or down the image with the rear control dial.
③ Select the portion you want to enlarge with **▲/▼/◀/▶** on the multi-selector.
- Each time you press the center of the multi-selector, the screen changes between the enlarged screen and the whole screen.

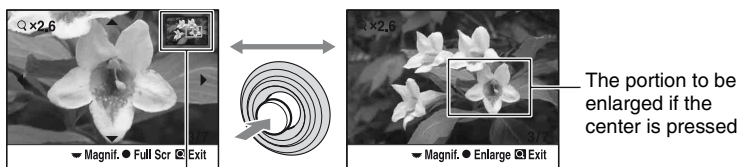

The map of the enlarged portion

- You can select an image with the front control dial.
- ④ Press the **Q** (Enlarge) or **▶** (Playback) button so that enlarged playback is canceled and the screen returns to the screen that was displayed before enlarging.

The scaling range is as follows.

Image size	Scaling range
L	Approx. $\times 1.1 - \times 13$
M	Approx. $\times 1.1 - \times 10$
S	Approx. $\times 1.1 - \times 6.7$

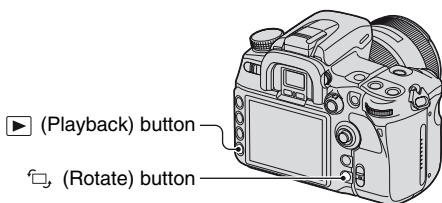

Rotating an image

At the default setting, images shot in the portrait orientation are played back in the portrait orientation. You can rotate images in the following way, if necessary.

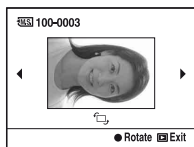

- 1 Display the image you want to rotate, then press the  (Rotate) button. The screen used for rotating images appears.



- 2 Press the center of the multi-selector to rotate the image to your desired orientation.
 - 3 Press the  (Playback) or  (Rotate) button to return to the normal screen.
- Once you rotate the image, the image is played back in the rotated position, even if you turn off the power.
 - When you copy rotated images to a computer, "Picture Motion Browser" contained on the CD-ROM (supplied) can display the rotated images correctly. However, the images may not be rotated depending on the software.

Viewing images on a TV screen

You can view images on a TV screen by connecting the camera to a TV.
Turn off both your camera and the TV before connecting the camera and the TV.

1 Connect the camera to the TV.

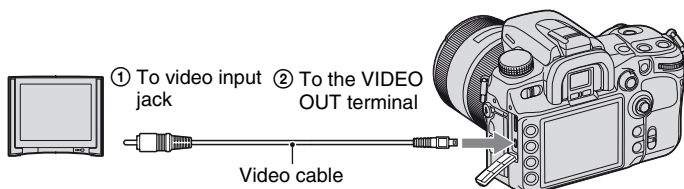

2 Turn on the TV and switch the input.

- See also the operating instructions supplied with the TV.

3 Turn on the camera, and press (Playback).

Images shot with the camera appear on the TV screen.
Select the desired image with  on the multi-selector.



- When using your camera abroad, it may be necessary to switch the video signal output to match that of your TV system (page 121).

- The LCD monitor on the rear of the camera does not turned on.
- The quality of images displayed on a TV connected with a video cable is lower for different systems, compared to images displayed on an HDTV connected with an HDMI cable or on a PC monitor.

When using an HDTV equipped with an HDMI connector

If you are using an HDTV equipped with an HDMI connector, you can view images higher image quality by using an HDMI cable (not supplied).

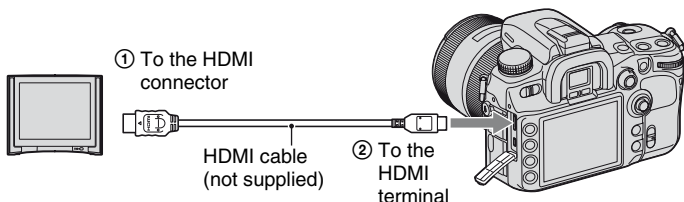

- ① Connect the camera to the TV with the HDMI cable.
- ② Turn on the TV and switch the input.
- ③ Turn on the camera.
The camera turns to the playback mode automatically.

- Use an HDMI cable with the HDMI logo.
- Use an HDMI mini connector on one end (for the camera), and a connector suitable for connection to your TV on the other end.
- By connecting your camera to Sony's VIDEO-A compatible TV using an HDMI cable, TV sets suitable image quality for viewing still picture automatically. Please refer to the operating instructions of Sony's VIDEO-A compatible TV for more details.
- Some devices may not work properly.
- Do not connect the output connector of the device with the HDMI terminal on the camera. This may cause a malfunction.
- You can change the type of output signal with [HDMI output] in the  Setup menu (page 121).

On "PhotoTV HD"

This camera is compatible with the "PhotoTV HD" standard.

By connecting Sony's PhotoTV HD-compatible devices using an HDMI cable, whole new world of photos can be enjoyed in breathtaking Full HD quality.

PhotoTV HD allows for a highly-detailed, photo-like expression of subtle textures and colors.

On TV color systems

If you want to view images on a TV screen, you need a TV with a video input jack and the video cable. The color system of the TV must match that of your digital still camera. Check the following lists for the TV color system of the country or region where the camera is used.

NTSC system

Bahama Islands, Bolivia, Canada, Central America, Chile, Colombia, Ecuador, Jamaica, Japan, Korea, Mexico, Peru, Surinam, Taiwan, the Philippines, the U.S.A., Venezuela, etc.

PAL system

Australia, Austria, Belgium, China, Czech Republic, Denmark, Finland, Germany, Holland, Hong Kong, Hungary, Italy, Kuwait, Malaysia, New Zealand, Norway, Poland, Portugal, Singapore, Slovak Republic, Spain, Sweden, Switzerland, Thailand, United Kingdom, etc.

PAL-M system

Brazil

PAL-N system

Argentina, Paraguay, Uruguay

SECAM system

Bulgaria, France, Guiana, Iran, Iraq, Monaco, Russia, Ukraine, etc.

Operating with the Remote Commander

Connecting the camera to a TV and turning to the playback mode allows you to play back images using the Remote Commander. Most of the buttons on the Remote Commander have the same functions as the buttons on the camera.

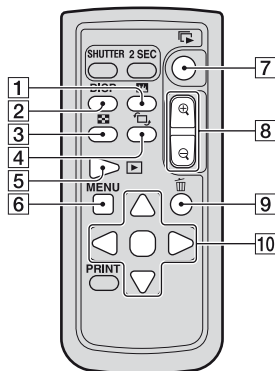

Buttons on the Remote Commander	Page
1 (Histogram)	85
2 (Display)	83
3 (Index)	84
4 (Rotate)	88
5 (Playback)	83
6 MENU	32
7 (Slide show)	119
8 (Scale up/down)	86
9 (Delete)	→ step 6 in "Read This First"
10	29

- The other buttons are used when the camera is in recording mode or is connected to a PictBridge printer (pages 60, 148).

Slide show





The (Slide show) button on the Remote Commander easily starts/stops a slide show (page 119). During a slide show, the following operations are available from the Remote Commander.

- Displaying the previous/next image with .
- Pausing/playing back the slide show with .





Menu list

For details on how to operate the menu, see page 32.

Recording menu (pages 94 to 104)

 1	 2
Image size Aspect ratio Quality D-RangeOptimizer Creative Style Custom button Exposure step	Flash mode Flash control <ul style="list-style-type: none"> • Power ratio Flash compens. ISO Auto max. ISO Auto min.
 3	 4
AF-A setup AF area Priority setup AF illuminator AF w/ shutter Long exp.NR High ISO NR	Memory Rec mode reset

Custom menu (pages 105 to 113)

 1	 2
Eye-Start AF EyeStart trigr. AF/MF button AF/MF control AF drive speed AF area disp. FocusHoldButton	AEL button Ctrl dial setup Dial exp.comp Ctrl dial lock Button ops. Release w/oCard Release w/oLens
 3	 4
Red eye reduc. Exp.comp.set Bracket order Auto review Auto off w/ VF Rec.info.disp. Img.orientation	Custom reset

▶ Playback menu (pages 114 to 119)

▶ 1	▶ 2
Delete Format Protect DPOF setup <ul style="list-style-type: none"> • Date imprint • Index print PlaybackDisplay	Slide show <ul style="list-style-type: none"> • Interval

🔧 Setup menu (pages 120 to 126)

🔧 1	🔧 2	🔧 3
LCD brightness Info.disp.time Power save Video output HDMI output  Language Date/Time setup	Memory card File number Folder name Select folder <ul style="list-style-type: none"> • New folder USB connection <ul style="list-style-type: none"> • MassStrg.card 	Menu start Delete confirm. Audio signals Cleaning mode Reset default

The default settings are marked with .

Image size

A digital image is made up of a collection of small dots called pixels.

“Image size” is shown by the number of pixels. Although you cannot see the differences on the screen of the camera, the fine detail and data processing time differ when the image is printed or displayed on a computer screen.

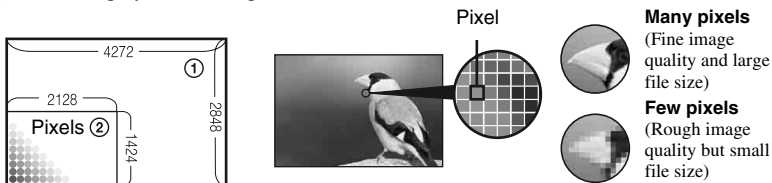

① Image size: L

② Image size: S

[Aspect ratio]: [3:2]

<input checked="" type="checkbox"/>	L:12M	4272 × 2848 pixels
<input type="checkbox"/>	M:6.4M	3104 × 2064 pixels
<input type="checkbox"/>	S:3.0M	2128 × 1424 pixels







[Aspect ratio]: [16:9]

<input checked="" type="checkbox"/>	L:10M	4272 × 2400 pixels
<input type="checkbox"/>	M:5.4M	3104 × 1744 pixels
<input type="checkbox"/>	S:2.6M	2128 × 1200 pixels

- When you select a RAW file with [Quality], the image size of the RAW file corresponds to L. This size is not displayed on the LCD monitor.
- You can also use the Fn (Function) button for operations (page 30).

 Selecting image size for use

Refer to the following table when selecting the image size.

Image size		Usage guidelines	No. of images	Printing
L	Larger  Smaller	For storing important images or printing A3/A3+* size or fine A4 size images	Less 	Fine 
M		For printing in A4 size or high density images in A5 size		
S		For recording a large number of images For creating web pages	More 	Rough 

* This is a size larger than A3 size. You can print images with a margin around the A3 size image.

Aspect ratio

You can select the aspect ratio to suit your purpose.

<input checked="" type="checkbox"/>	3:2	A normal ratio.
<input type="checkbox"/>	16:9	An HDTV ratio. [16:9] is recommended when viewing on an HDTV.

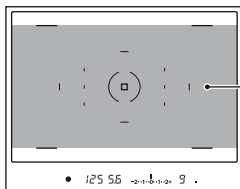

When [16:9] is selected, make your composition in this area.

- RAW files recorded in 16:9 ratio are displayed in 16:9 ratio using compatible software, such as "Image Data Converter SR", but they are displayed in 3:2 ratio if the software is not compatible with this ratio.

Quality

The image compression rate determines the image quality. As the file size of the uncompressed image will be larger, it is common for a digital camera to compress the recorded image.

	RAW (RAW)	File format: RAW (raw data) A RAW file is the raw material to be processed on the computer for professional purposes. The file can be opened with the “Image Data Converter SR” provided on the CD-ROM (supplied) (page 139). “c” of “cRAW” means “compressed”.	
	cRAW* (cRAW)	<ul style="list-style-type: none"> The image size is fixed to the maximum size. The image size is not displayed on the LCD monitor. 	
	RAW & JPEG (RAW+J)	File format: RAW (raw data) + JPEG A RAW image and a JPEG image are created at the same time. This is suitable when you need two image files, a JPEG for viewing, and a RAW for editing. The image quality is fixed to [Fine].	
	cRAW & JPEG* (cRAW+J)		
	Extra fine (X.FINE)	File format: JPEG The image is compressed in the JPEG format when recorded. The higher the compression rate, the smaller the file size. This will allow more files to be recorded in one memory card, but the image quality will be lower.	Compression ratio Low  High
✓	Fine (FINE)	Once the image quality is lowered, it cannot be restored on a computer afterwards. If you plan to process or edit the image file later, consider the image quality carefully when selecting the setting.	
	Standard (STD)		

* The data is compressed up to about 60 to 70% compared to an image not compressed. Use this setting when you want to increase the number of images that can be taken.

- You can also use the Fn (Function) button for operation (page 30).
- For details on the number of images that can be taken when the image quality is changed, see page 24.

About RAW files

The RAW format file is the raw data yet to go through any kind of digital processing. A RAW file is different from a more common file format such as JPEG in that it is the raw material to be processed for professional purposes. You need the “Image Data Converter SR” software included on the CD-ROM (supplied) in order to open a RAW file recorded on this camera. With this software, a RAW file can be opened and converted to a common format, such as JPEG or TIFF, and its white balance, color saturation, contrast, etc., can be readjusted.

- Recording a RAW format image entails the following limitations.
 - The RAW file cannot be printed using a DPOF (print) designated printer or a PictBridge compliant printer.
 - Unlike a JPEG image, a RAW image does not go through any basic image processing, so its colors cannot be accurately reproduced in playback mode or on an auto review screen. If the data is correctly recorded, accurate colors can be reproduced on a computer.
- You cannot verify the effects of D-Range Optimizer other than those of **D-R** (Standard) if you play back and enlarge an image recorded in RAW or cRAW format.

D-RangeOptimizer

You can analyze the recorded scene and make automatic adjustments to optimize the image quality.

Off (D-Off)	For details, see page 66.
Standard (D-R)	
Advanced Auto (D-RH)	
Advanced: Level (D-RH) Lv 1 – Lv 5	

Creative Style

You can select image styles most suitable for the recorded scenes and purposes.

<input checked="" type="checkbox"/>	Standard (Standard)	For details, see page 67.
<input type="checkbox"/>	Vivid (Vivid)	
<input type="checkbox"/>	Neutral (Neutral)	
<input type="checkbox"/>	Adobe RGB (AdobeRGB)	
<input type="checkbox"/>	1	
<input type="checkbox"/>	2	
<input type="checkbox"/>	3	

Custom button

You can assign a function to the C (Custom) button.

	AF lock	For details, see page 81.
	AF/MF control	
	D.O.F.preview	
	ISO	
	White balance	
	Exposure comp.	
	Flash compens.	
	Drive mode	
	AF area	
	Image size	
	Quality	
✓	Creative Style	
	D-RangeOptimizer	
	Flash mode	
	Memory	

Exposure step

You can select a 0.5 or 0.3 compensation increment for shutter speed, aperture, and exposure.

	0.5 EV	Changes in 1/2 EV steps
✓	0.3 EV	Changes in 1/3 EV steps

The default settings are marked with .

Flash mode

You can select the flash mode.

	Autoflash (AUTO)	For details, see page 73.
	Fill-flash (⚡)	
	Rear sync. (REAR)	
	Wireless (WL)	

Flash control

You can select the flash control mode to set the amount of flash light.

	ADI flash	A pre-flash is fired right before shooting, and the camera sets the amount of flash light by measuring the amount of reflected light from the pre-flash and the associated distance information.
	Pre-flash TTL	A pre-flash is fired right before shooting, and the camera sets the amount of flash light by measuring only the amount of reflected light from the pre-flash. The distance information is not used in the calculation.
	Manual flash	The built-in flash fires with certain amount of flash light regardless of the brightness of a subject. This option is disabled when [Autoflash] is selected.

ADI: Advanced Distance Integration

TTL: Through the lens

- When the distance between the subject and the external flash (not supplied) cannot be determined, (wireless flash shooting using an external flash (not supplied), shooting with an off-camera flash using a cable, shooting with a macro twin flash, etc.) the camera automatically selects Pre-flash TTL mode.
- Select [Pre-flash TTL] in the following cases, as the camera cannot obtain accurate distance information with ADI flash.
 - A wide panel is attached to the HVL-F36AM flash.
 - A diffuser is used for flash shooting.
 - A filter with an exposure factor, such as an ND filter, is used.
 - A close-up lens is used.
- ADI flash is only available in combination with the lens that is provided with a distance encoder. To determine the lens is equipped with a distance encoder, refer to the operating instructions supplied with the lens.

Power ratio

You can select the amount of light when [Flash control] is set to [Manual flash].

<input checked="" type="checkbox"/>	1/1	Guide number approx. 12
<input type="checkbox"/>	1/2	Guide number approx. 8.4
<input type="checkbox"/>	1/4	Guide number approx. 6
<input type="checkbox"/>	1/8	Guide number approx. 4.2
<input type="checkbox"/>	1/16	Guide number approx. 3

- Under the condition in meter at ISO 100

Flash compens.

For details, see page 75.

ISO Auto max.

You can select the upper limit of an ISO AUTO value when the mode dial is set to P, A, or S, and ISO is set to [AUTO].

<input type="checkbox"/>	1600	Automatically adjusts ISO with the selected value set to the upper limit.
<input checked="" type="checkbox"/>	800	
<input type="checkbox"/>	400	

ISO Auto min.

You can select the lower limit of an ISO AUTO value when the mode dial is set to P, A, or S, and ISO is set to [AUTO].

<input type="checkbox"/>	400	Automatically adjusts ISO with the selected value set to the lower limit.
<input checked="" type="checkbox"/>	200	

The default settings are marked with ✓.

AF-A setup

The position “A” of the focus mode lever is set to AF-A (Automatic AF) (page 52) at the default setting. You can change the function to DMF (Direct man. focus).

✓	AF-A (AF-A)	Assigns the Automatic AF function.
	DMF (DMF)	Assigns the Direct man. focus function. You can make a fine adjustment after adjusting the focus in auto focus.

To make a fine adjustment in Direct Manual Focus

- ① Set to [DMF].
- ② Set the focus mode lever to “A”.
- ③ Press the shutter button halfway down to lock the focus.
- ④ Turn the focusing ring to fine-tune the focus while pressing the shutter button halfway down.

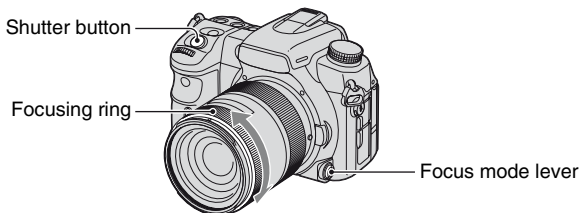

- ⑤ Press the shutter button fully down.
- Once you release your finger from the shutter button, the focus lock operation starts again from the beginning when you press the shutter button halfway down.

AF area

You can select the AF area.

✓	Wide ()	For details, see page 49.
	Spot ()	
	Local ()	

Priority setup

Select a setting for shutter release.

<input checked="" type="checkbox"/>	AF	The shutter cannot be released when the focus is not confirmed.
<input type="checkbox"/>	Release	The shutter can be released even when the focus is not confirmed. Select this setting if the shooting opportunity takes precedence.

AF illuminator

You can set the AF illuminator to on or off. For details on the AF illuminator, see page 54.

<input checked="" type="checkbox"/>	Auto	Automatically fills the AF illuminator if necessary.
<input type="checkbox"/>	Off	Does not fill the AF illuminator.

- When [AF illuminator] is set to [Off], the AF illuminator of an external flash (not supplied) is not triggered.

AF w/ shutter

At the default setting, adjusting the focus is carried out by pressing the shutter button halfway down. You can deactivate this action.

<input checked="" type="checkbox"/>	On	Adjusts the focus by pressing the shutter button halfway down.
<input type="checkbox"/>	Off	Does not adjust the focus by pressing the shutter button halfway down.

- When it is set to [Off], adjust the focus by pressing the center of the multi-selector. The shutter can be released even when the focus is not confirmed. This is useful when shooting continuously at the same focus position. Setting [AF/MF button] to [AF lock] or assigning AF lock to the C (Custom) button can also adjust the focus.

Long exp.NR

Long exposure makes noise conspicuous. When the shutter speed is one second or slower, noise reduction is activated to reduce the grainy noise that is common in long exposures.

✓	On	When a long exposure of one second or longer takes place, the noise reduction process is performed for the duration that the shutter was open. While the noise reduction is being performed, the message “Processing...” appears on the LCD monitor. You cannot take the next picture until the process is over.
	Off	This mode does not perform noise reduction. This is suitable when timing of shooting takes precedence. However, this makes the noise more conspicuous. It is recommended that you activate the noise reduction if you use long exposure.

- Noise reduction is not performed on continuous shooting or continuous bracketing even when it is set to [On].

High ISO NR

When the camera sensitivity is set high, noise in the pictures tends to become more noticeable. When the ISO is set to 1600 or above, High ISO noise reduction is automatically activated to lower the noise.

	High	High ISO noise reduction is high.
✓	Normal	High ISO noise reduction is normal.
	Low	High ISO noise reduction is low.

- When [High] is selected, the speed of continuous shooting becomes approx. 3.5 images/sec.

Memory

For details, see page 79.

Rec mode reset

You can reset the main functions of the recording mode when the mode dial is set to P, A, S, or M.

- ① Select [Rec mode reset], then press the center of the multi-selector.
The message “Reset recording mode?” appears on the LCD monitor.
 - ② Select [OK] with ▲ on the multi-selector, then press the center of the multi-selector.
The main functions of the recording mode are reset.
- The items to be reset are the functions operated with the exclusive buttons and all the items in the  Recording menu. For details on the items to be reset, see “Reset default” (page 172).

The default settings are marked with ✓.

Eye-Start AF

The focus is confirmed when you hold the grip and look into the viewfinder, and the shutter speed and aperture are adjusted automatically.

✓	On	Automatically adjusts the focus. • This mode uses up the battery charge faster than [Off].
	Off	Does not adjust the focus.

EyeStart trigr.

You can start Eye-Start AF without holding the grip.

✓	w/ GripSensor	The focus is automatically confirmed when you hold the grip and look into the viewfinder.
	w/o GripSensor	The focus is automatically confirmed when you look into the viewfinder. Holding the grip is not necessary to activate the auto focus.

- When you take pictures with a tripod and your fingers are not on the grip or when you shoot with gloves on, the Eye-Start AF will not be activated even if [w/ GripSensor] is selected. Also, when your hands are dry, this function may not be fully effective. In such cases, select [w/o GripSensor] or confirm the focus by holding the shutter button halfway down.

AF/MF button

The AF/MF button switches between AF (auto focus) and MF (manual focus) in the default setting (page 53). This button can be used as the AF Lock button.

✓	AF/MF control	See page 53.
	AF lock	Uses the button as the AF lock button. Press the button and the focus is locked there when the auto focus is activated. If the auto focus is not activated, this button activates it, and the focus will be confirmed and locked. Press the shutter button to take pictures while holding the AF/MF button down.

AF/MF control

When [AF/MF button] is set to [AF/MF control] (page 105), you can change how you operate the AF/MF button.

✓	Hold	AF and MF are switched only while the button is held down.
	Toggle	Press and release the button to switch AF and MF. Press and release the button again to go back to the previous setting.

AF drive speed

You can select the speed of focusing when the auto focus is activated.

✓	Fast	Confirms the focus quickly.
	Slow	Confirms the focus slowly. • Use this setting when a subject is a little hard to focus on, such as in macro shooting.

AF area disp.

When the shutter button is pressed halfway down, the local AF area in focus is briefly illuminated in red. You can change the duration of illumination or turn off the illumination.

	0.6 sec	The local AF area is illuminated for 0.6 seconds.
✓	0.3 sec	The local AF area is illuminated for 0.3 seconds.
	Off	The local AF area is illuminated only when the multi-selector is pressed.

FocusHoldButton



If you use a lens equipped with a focus hold button, you can change the function of the button to preview a shot.

✓	Focus hold	Uses the button as the focus hold button.
	D.O.F.preview	Uses the focus hold button as the depth-of-field preview button.

The default settings are marked with .

AEL button





The function and the mode of operation of the AEL (AE lock) button can be changed. The AEL (AE lock) button has two functions; an “AEL” function that locks the exposure value (shutter speed and aperture) in any metering mode, and a “ (Spot) AEL” function that temporarily performs spot metering and locks the acquired exposure value. The AEL button has two modes of operation; “hold” that functions only when the button is held down, and “toggle” that switches between activation and deactivation each time the button is pressed. Of these, the following combinations are available.

	AEL hold	While the button is held down, the exposure value in the selected metering mode is locked.
	AEL toggle	Press the button once and release it, and the exposure value in the selected metering mode stays locked. Press the button again, and the lock is released.
	 AEL hold	While the button is held down, the camera temporarily performs spot metering regardless of the metering mode previously selected and locks the acquired exposure value.
	 AEL toggle	Press the button once and release it, and the camera temporarily performs spot metering regardless of the metering mode previously selected and locks the acquired exposure value. Press the button again, and the lock is released.

- “AEL” is useful when you want to keep regular exposures on multiple images and “hold” is useful when you want to temporarily use the spot metering.
- While the exposure value is locked,  appears on the LCD monitor and in the viewfinder. Be sure to remember to release the lock when “AEL toggle” is selected.
- Except when shutter speed priority mode or the manual mode is selected, slow sync is selected automatically whenever the flash is used. In this case, spot metering is disabled and “hold” and “toggle” are the only switchable alternatives (page 77).
- The “hold” and “toggle” settings affect the manual shift (page 43) in the manual mode.

Ctrl dial setup



When the mode dial is set to P or M, adjusting the shutter speed is performed with the front control dial and adjusting the aperture is performed with the rear control dial at the default setting. You can reverse this assignment.



	 SS  F/no.	Adjusts the shutter speed with the front control dial and adjusts the aperture with the rear control dial.
	 F/no.  SS	Adjusts the aperture with the front control dial and adjusts the shutter speed with the rear control dial.



- When the mode dial is set to A or S, this assignment is not available.

Dial exp.comp



You can adjust the exposure (page 45) with the front or rear control dial.

<input checked="" type="checkbox"/>	Off	Does not adjust the exposure with the dials.
	Front dial	Adjusts the exposure with the front control dial.
	Rear dial	Adjusts the exposure with the rear control dial.

When [Ctrl dial setup] is set to [SS F/no.], the functions of the front and rear control dials are as follows.

Mode		Off	 Front dial	 Rear dial
P	Front control dial	P _S shift	Exposure	P _S shift
	Rear control dial	P _A shift	P _A shift	Exposure
A	Front control dial	Aperture	Exposure	Aperture
	Rear control dial	Aperture	Aperture	Exposure
S	Front control dial	Shutter speed	Exposure	Shutter speed
	Rear control dial	Shutter speed	Shutter speed	Exposure
M	Front control dial	Shutter speed	Shutter speed	Shutter speed
	Rear control dial	Aperture	Aperture	Aperture

When [Ctrl dial setup] is set to [F/no. SS], the functions of the front and rear control dials are as follows.

Mode		Off	 Front dial	 Rear dial
P	Front control dial	P _A shift	Exposure	P _A shift
	Rear control dial	P _S shift	P _S shift	Exposure
A	Front control dial	Aperture	Exposure	Aperture
	Rear control dial	Aperture	Aperture	Exposure
S	Front control dial	Shutter speed	Exposure	Shutter speed
	Rear control dial	Shutter speed	Shutter speed	Exposure
M	Front control dial	Aperture	Aperture	Aperture
	Rear control dial	Shutter speed	Shutter speed	Shutter speed

Ctrl dial lock

You can lock the front and rear control dials to prevent them from accidentally rotating and changing the settings when you are carrying the camera.

	On	The front and rear control dial function only when the shutter speed and the aperture are displayed.
<input checked="" type="checkbox"/>	Off	The front and rear control dial function at all times.

Button ops.

In the default setting, pressing the ISO button, WB (White Balance) button, DRIVE button,  (Exposure) button, or C (Custom) button will put the exclusive screen on the display. You can choose to have the Quick Navi screen (page 30) displayed instead.

<input checked="" type="checkbox"/>	Exclusive disp	Displays an exclusive screen for each mode.
	Quick Navi	Displays the Quick Navi screen of the mode selected at the time.

- Even if [Quick Navi] is selected, the exclusive screen will be displayed when no item is applicable on the enlarged display screen.

Release w/oCard

You can set the shutter lock to keep the shutter from releasing when no memory card is inserted in the camera.

<input checked="" type="checkbox"/>	Enable	The shutter can be released when no memory card is inserted in the camera.
	Disable	The shutter cannot be released when no memory card is inserted in the camera.

Release w/oLens

You can set the shutter lock to keep the shutter from releasing when no lens is mounted on the camera. When attaching the camera to an astronomical telescope, for example, select [Enable] so the shutter can be released.

	Enable	The shutter can be released when no lens is mounted on the camera.
<input checked="" type="checkbox"/>	Disable	The shutter cannot be released when no lens is mounted on the camera.

The default settings are marked with ✓.

Red eye reduc.

Reduces the red-eye phenomenon by providing low-flash light a few times before shooting when using the flash.

	On	Reduces the red-eye phenomenon.
✓	Off	Does not use red-eye reduction.

- Red-eye reduction is available only with the built-in flash. (When using an external flash (not supplied), the red-eye phenomenon rarely occurs.)

Exp.comp.set

In the default setting, if exposure compensation is selected when the flash is used, shutter speed, aperture, ISO sensitivity (only in AUTO mode), and amount of flash light all change in order to perform exposure compensation (page 45). By fixing the amount of flash light, you can limit the effect of exposure compensation to the background that is illuminated only by ambient light (light other than the flash).

✓	Ambient&flash	Exposure compensation is performed on both the ambient light range (the background that the flash light does not reach) and the flash light range. <ul style="list-style-type: none"> • Values that change: shutter speed, aperture, ISO (only in AUTO mode), amount of flash light • Values that do not change: none
	Ambient only	The exposure compensation is limited to the ambient light range (the background), while the exposure of the flash light range is fixed. <ul style="list-style-type: none"> • Values that change: shutter speed, aperture, ISO (only in AUTO mode) • Values that do not change: amount of flash light

- With the flash compensation, you can limit the compensation to flash light range by fixing the exposure of ambient light range that the flash light does not reach (page 75).
 Values that change: amount of flash light
 Values that do not change: shutter speed, aperture, ISO

Bracket order

The order in bracket shooting (page 57) can be selected. This does not apply to DRO advanced bracket.



<input checked="" type="checkbox"/>	0 → - → +	Uses 0 EV in shooting the first picture which presents the best shooting opportunity. Example: ±0EV → -0.3EV → +0.3EV → -0.7EV → +0.7EV
<input type="checkbox"/>	- → 0 → +	Ordered from low to high exposure. Example: -0.7EV → -0.3EV → ±0EV → +0.3EV → +0.7EV

Auto review

After an image is recorded, you can display it on the LCD monitor for two, five, or 10 seconds. You can also delete it during instant playback.

<input type="checkbox"/>	10 sec	Displays the image on the LCD monitor for 10 seconds.
<input type="checkbox"/>	5 sec	Displays the image on the LCD monitor for five seconds.
<input checked="" type="checkbox"/>	2 sec	Displays the image on the LCD monitor for two seconds.
<input type="checkbox"/>	Off	Deactivates auto review.

To delete the image during instant playback

Press  (Delete), then select [Delete] on the confirmation screen with  on the multi-selector, then press the center of the multi-selector.

- When an image recorded in Local AF area is enlarged on the auto review screen, the image is enlarged from around the selected area used for focus adjustment.
- Auto review of continuous shooting, and bracket shooting shows only the image recorded last. If you delete the image following the process above, only the displayed image is deleted.
- In auto review, the image will not be displayed in the vertical position even if you shot the image in a vertical position (page 112).

Auto off w/ VF

The eyepiece sensors located right below the viewfinder determine whether the photographer is looking into the viewfinder or not. The LCD monitor can be set to turn off automatically when you are looking into the viewfinder.

<input checked="" type="checkbox"/>	On	The LCD monitor turns off automatically when you look into the viewfinder.
<input type="checkbox"/>	Off	The LCD monitor stays on when you look into the viewfinder.

- Regardless of the setting in this menu, the recording information display automatically turns off after a set duration (five seconds in the default setting (page 120)).

Rec. info. disp.

You can set the recording information display to rotate automatically when the camera is in a vertical position.

<input checked="" type="checkbox"/>	Auto rotate	The display rotates automatically to a vertical position when the camera is in a vertical position.
<input type="checkbox"/>	Horizontal	The display does not rotate when the camera is in a vertical position.

Img. orientation

You can select whether or not the image orientation information is recorded with the image.

<input checked="" type="checkbox"/>	Record	<p>The image orientation is recorded with the image.</p> <ul style="list-style-type: none"> When [PlaybackDisplay] is set to [Auto rotate] in the  Playback menu, the image is played back in a vertical position (page 118).
<input type="checkbox"/>	Not record	The image orientation is not recorded with the image.

- When [Record] is selected, an image loaded on a computer will be displayed in the vertical position with "Picture Motion Browser"/"Image Data Converter SR" (supplied). The image may not be displayed in a vertical position, depending on the software employed.
- To rotate the displayed image manually, see page 88.

Custom reset

The settings in the ⚙ Custom menu are all reset to the default settings.

- ① Select [Custom reset], then press the center of the multi-selector.
The message “Reset custom functions?” appears on the LCD monitor.
- ② Select [OK] with ▲ on the multi-selector, then press the center.
The setting in the ⚙ Custom menu are reset.

The default settings are marked with ✓.

Delete

You can delete unnecessary images. Follow the procedure below.

✓	Marked images	Deletes only the selected images.
	All images	Deletes all the images on the memory card.

- Once you have deleted an image, you cannot restore it.
- Protected images cannot be deleted.
- Use the  (Delete) button to quickly delete images shot by shot (→ step 6 in “Read This First”).

To delete selected images

- ① Select [Marked images] in [Delete].
- ② Select the image you want to delete with ◀/▶ on the multi-selector, then press the center of the multi-selector.
A  mark appears on the selected image.

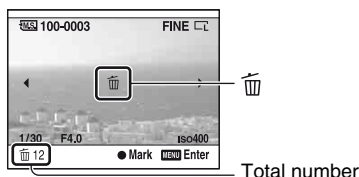

- To cancel a selection, press the center again.
- ③ To delete other images, repeat step ②.
 - To cancel, press ▶ (Playback).
 - ④ Press MENU.
The message “Delete images?” appears.
 - ⑤ Select [Delete] with ▲ on the multi-selector, then press the center of the multi-selector.
The selected images are deleted, and the screen returns to the playback screen.

To delete all images

- ① Select [All images] in [Delete].
The message “Delete all images on card?” appears.
- ② Select [Delete] with ▲ on the multi-selector, then press the center of the multi-selector.
All the images are deleted, and the screen returns to the playback screen.

Format

Formats the memory card.

- Note that formatting irrevocably erases all data on a recording medium, including protected images.

① Select [Format].

The message “All data will be deleted. Format?” appears.

② Select [OK] with ▲ on the multi-selector, then press the center of the multi-selector.

The format is completed.

- During the format, the access lamp lights up. Do not eject the memory card while the lamp is lit.
- Format the memory card using the camera. If you format it on a computer, the memory card may not be usable with the camera, depending on the format type used.
- You cannot format a “Memory Stick Duo” that is inserted into the CF card insertion slot using an adaptor. To format it, directly insert into the “Memory Stick Duo” insertion slot.

Protect

Protects images against accidental erasure. Follow the procedure below.

<input checked="" type="checkbox"/>	Marked images	Protects only the selected images.
<input type="checkbox"/>	All images	Protects all the images on the memory card.
<input type="checkbox"/>	Cancel all	Cancels the protection of all the images on the memory card.

To protect selected images

① Select [Marked images] in [Protect].

② Select the image you want to protect with ◀/▶ on the multi-selector, then press the center of the multi-selector.

A  mark appears on the selected image.

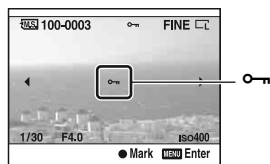

- To cancel a selection, press the center again.

③ To protect other images, repeat step ②.

- To cancel, press ▶ (Playback).

④ Press MENU.

The message “Protect images?” appears.

⑤ Select [OK] with ▲ on the multi-selector, then press the center of the multi-selector.

The image is protected, and the screen returns to the playback screen.

To protect all the images

- ① Select [All images] in [Protect].
The message “Protect images?” appears.
- ② Select [OK] with ▲ on the multi-selector, then press the center of the multi-selector.
The image is protected, and the screen returns to the playback screen.

To cancel the protection

- ① Select [Cancel all] in [Protect].
The message “Cancel all?” appears.
- ② Select [OK] with ▲ on the multi-selector, then press the center of the multi-selector.
The image protection is canceled, and the screen returns to the playback screen.

DPOF setup

Using the camera, you can specify the images and the number of images to print before you print images at a shop or with your printer. Follow the procedure below.

✓	Marked images	Specifies DPOF only on the selected images.
	All images	Specifies DPOF on all the images in the memory card.
	Cancel all	Unspecifies DPOF on all the images in the memory card.

- You cannot mark RAW data files.
- You can specify any number up to 9.

To specify DPOF on selected images

- ① Select [Marked images] in [DPOF setup].
- ② Select the image you want to mark with ◀/▶ on the multi-selector, then select the number of sheets with the rear control dial.
A DPOF mark appears on the selected image, and the number of sheets is selected.

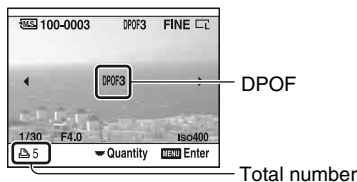

- To cancel a selection, rotate the rear control dial to remove the DPOF mark.
- ③ To specify DPOF on other images, repeat step ②.
 - To cancel, press ▶ (Playback).
 - ④ Press MENU.
The message “Set DPOF?” appears.
 - ⑤ Select [OK] with ▲, then press the center of the multi-selector.
The DPOF is specified on the selected images, and the screen returns to the playback screen.

To specify DPOF on all the images

- ① Select [All images] in [DPOF setup].
The message “Number of copies?” appears.
 - ② Select a number of sheets with ▲/▼ on the multi-selector, then press the center of the multi-selector.
The message “Set DPOF?” appears.
 - ③ Select [OK] with ▲, then press the center of the multi-selector.
The DPOF is specified on all the images, and the screen returns to the playback screen.
- If you insert a memory card that contains DPOF-marked images specified with other cameras into this camera, then specify images to which to attach a DPOF-mark, the DPOF specifications made with other cameras are canceled.

To unspecify DPOF on all the images

When you do so, the index print is also canceled. Since the DPOF marks are left on after printing, it is recommended that you just clear the marks.

- ① Select [Cancel all] in [DPOF setup].
The message “Cancel all?” appears.
- ② Select [OK] with ▲ on the multi-selector, then press the center of the multi-selector.
The DPOF is unspecified on all the images, and the screen returning to the playback screen.

Date imprint

You can impose the date onto images when printing images. The position of the date (inside or outside the image, character size, etc.) depends on your printer.

<input type="checkbox"/>	On	Imposes the date.
<input checked="" type="checkbox"/>	Off	Does not impose the date.

- Normally, only the date is inserted, however, imposed items may be different depending on the printer. This function may not be provided, depending on the printer.

Index print

You can create an index print of all the images in the memory card.

Create index	Specifies an index print.
Delete index	Does not specify an index print.

- The number of images to print on a sheet and the format depend on the printer. RAW images do not print in index print.
- The images you shot after setting the index print are not included in the index print. It is recommended that you create the index print just before printing it.

PlaybackDisplay

When you play back an image recorded in the portrait position, the camera detects the orientation of the image and automatically displays it in the correct position.

	Auto rotate	Displays the image in the portrait position, if required.
	Manual rotate	Displays all images in the landscape position.

- When you play back the image on a TV or a computer, it will be displayed in the portrait position even if [Manual rotate] is selected.
- If [Not record] is selected with [Img.orientation] in the  Custom menu, the image will not be displayed in the portrait position (page 112).

The default settings are marked with ✓.

Slide show

Plays back recorded images in order (Slide show).

Select [Slide show], then press the center of the multi-selector.

The slide show starts and ends automatically after all the images have been played back.

To pause the slide show, press the center of the multi-selector. Pressing again starts the slide show again.

To end in the middle of the slide show, press the MENU button.

- You can view the previous/next image with ◀▶ during a slide show.

Interval

You can choose the interval between the images in the slide show mode.



	30 sec	The image switches every 30 seconds.
	10 sec	The image switches every 10 seconds.
	5 sec	The image switches every five seconds.
✓	3 sec	The image switches every three seconds.
	1 sec	The image switches every one second.

The default settings are marked with .

LCD brightness

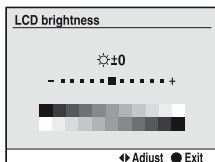
You can adjust the brightness of the LCD monitor.



- ① Select [LCD brightness], then press the center of the multi-selector.
 - ② Adjust the brightness with   on the multi-selector, then press the center of the multi-selector.
- On the recording information or playback screen, you can adjust the brightness by pressing the DISP (Display) button a little longer.

Info. disp. time

During shooting, the recording information display appears on the LCD monitor. You can change the displayed time of the display.

	1 min	Displays for one minute.
	30 sec	Displays for 30 seconds.
	10 sec	Displays for 10 seconds.
	5 sec	Displays for five seconds.

- The display appears again if you press the shutter button halfway down or perform some other operation.

Power save

If you do not operate the camera for given period of time, the camera turns to power saving mode and almost completely shuts down (Power Save). → *step 4 in "Read This First"*
You can set the time to turn the camera to the power save mode.

	30 min	The camera turns to power save mode after 30 minutes.
	10 min	The camera turns to power save mode after 10 minutes.
	5 min	The camera turns to power save mode after five minutes.
	3 min	The camera turns to power save mode after three minutes.
	1 min	The camera turns to power save mode after one minute.

- Pressing the shutter button halfway down returns the camera to the recording mode.

- Regardless of the setting here, the camera turns to power save mode after 30 minutes when the camera is connected to a TV. However, when connected to a TV with an HDMI cable (not supplied) and using an AC Adaptor/charger (not supplied), the power save feature does not function.

Video output

Sets the video signal output according to the TV color system of the connected video equipment. Different countries and regions use different TV color systems. If you want to view images on a TV screen, check page 90 for the TV color system of the country or region where the camera is used.

NTSC	Sets the video output signal to NTSC mode (e.g., for the USA, Japan).
PAL	Sets the video output signal to PAL mode (e.g., for Europe).

HDMI output



When you connect the camera with an HDTV using an HDMI terminal (page 90), the output signal from this camera is determined automatically. When displaying images recorded with a camera, other signals may make the image clearer, depending on the subject. You can make the following changes.

<input checked="" type="checkbox"/>	HD(1080i)prior.	Prioritizes HD (1080i) signal output.
<input type="checkbox"/>	HD(720p)prior.	Prioritizes HD (720p) signal output.
<input type="checkbox"/>	SD priority	Prioritizes SD (standard) signal output

- The above settings do not apply if the TV does not support the selected signal, in which case the camera outputs the signal supported by the TV.

Language

Select the language to be used to display the menu items, warning, and messages.

- ① Select [ Language], then press the center of the multi-selector.
- ② Select the desired language with / on the multi-selector, then press the center of the multi-selector.

Date/Time setup

Sets the date and time.

Select [Date/Time setup], then press the center of the multi-selector. Set the date and time again on the Date/Time setup screen.

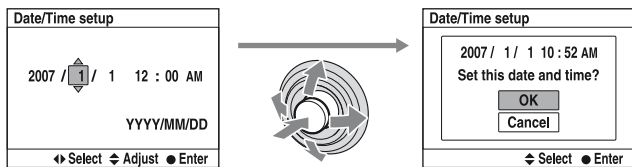

- For the procedure on setting the date and time, see *step 4* in "Read This First".

The default settings are marked with ✓.

Memory card

You can select the types of memory cards that you use for recording or playback.

	Memory Stick	Uses the “Memory Stick Duo” for recording or playback.
✓	CompactFlash	Uses the CF card/Microdrive for recording or playback.

File number

Selects the method used to assign file numbers to images.

✓	Series	Assigns numbers to files in sequence even if the recording folder or the memory card is changed, or all of the images are deleted.
	Reset	Starts from 0001 each time the folder is changed or each time a recording date changes when using a date form folder. When the recording folder contains a file, a number one higher than the largest number is assigned.

Folder name

The default standard form folder (100MSDCF, etc.) can be changed to a date form folder to classify the folders by date for storage and playback.

✓	Standard form	Selects the standard form folder.
	Date form	Selects the date form folder. A new folder will be created automatically every time a recording date changes.

- The folders and images saved in the standard form folder will retain their names.
- If the [Date form] is selected, the folder name will be displayed as follows.

Example:

101	7	01	01
-----	---	----	----

A

B

Ⓐ: Folder number

Ⓑ: Y (the last digit) / MM / DD

Select folder

When a standard form folder is selected and there are two or more folders, you can select the recording folder to be used to record images.

- ① Select [Select folder], then press the center of the multi-selector.
 - ② Select the desired folder with ▲/▼ on the multi-selector, then press the center of the multi-selector.
- You cannot select the folder when you are setting [Date form].

New folder

Creates a folder in a memory card for recording images.

A new folder is created with a number incremented one higher than the largest number currently used, and the folder becomes the current recording folder.

USB connection

Selects the USB mode to be used when connecting the camera to a computer, etc., using a USB cable.

✓	Mass Storage	Used for copying images to the computer. The camera is recognized as a USB mass storage device.
	PTP	Prints the images with a PictBridge compliant printer or copies images to PTP (Picture Transfer Protocol) compliant devices. <ul style="list-style-type: none"> • For details on printing with a PictBridge compliant printer, see page 146.
	Remote PC	Using “Remote Camera Control” contained on the CD-ROM (supplied), you can operate some functions of the camera (such as shooting) from a computer, store the recorded images to a computer, etc.



MassStrg.card



When the Mass Storage connection is used and a “Memory Stick Duo” and a CF card/Microdrive are both inserted in the camera, both can be displayed depending on the PC used.

	Both cards	Displays both the “Memory Stick Duo” and CF card/Microdrive. This is supported by a PC running Windows 2000 SP3, or a later version of OS.
✓	Selected card	Displays only the card selected with [Memory card].

The default settings are marked with ✓.

Menu start

In the default setting, when you press the MENU button, the  1 or  1 menu screen is displayed first. You can change this setting to display the previously selected menu screen first.

✓	Top	Displays the  1 or  1 menu screen first.
	Previous	Displays the previously selected menu screen first.

Delete confirm.

Before deleting images or folders, a confirmation screen, such as “Delete images?”, appears. Normally, [Cancel] is selected by default, but you can set this default option so that [Delete] is selected.

	“Delete” first	[Delete] is selected by default.
✓	“Cancel” first	[Cancel] is selected by default.

Audio signals

Selects the sound produced when the shutter is locked, during self-timer countdown, etc.

✓	On	Turns on the sound.
	Off	Turns off the sound.

Cleaning mode

If dust or debris enters the camera and lands on the image sensor (the part that acts as the film), it may appear on the photo image, depending on the shooting environment. If there is dust on the image sensor, use a commercially available blower and clean the image sensor following the steps below. You can easily clean the image sensor using only the blower and the anti-dust function.

• **Cleaning can be performed only when the battery level is  (three remaining battery icons) or more. Low battery power during cleaning can cause damage to the shutter. The cleaning should be completed quickly.**

- ① Confirm that the battery is fully charged.
 - The use of an AC Adaptor/charger (not supplied) is recommended.
- ② Select [Cleaning mode], then press the center of the multi-selector.
The message “After cleaning, turn camera off. Continue?” appears.
- ③ Select [OK] with ▲ on the multi-selector, and press the center of the multi-selector.

- After the image sensor vibrates for a short time, the mirror in front is lifted.
- ④ Detach the lens.
- ⑤ Use the blower to clean the image sensor surface and the surrounding area.

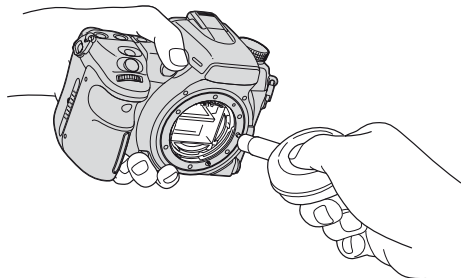

- Do not touch the image sensor with the tip of the blower. Complete the cleaning quickly.
 - Hold the camera's face downward to prevent the dust from resettling in the camera.
 - Do not use a spray blower because it may scatter vapor inside the camera body.
 - **When cleaning the image sensor, do not put the tip of a blower into the cavity beyond the lens mount. You do not need to put the blower close to the image sensor.**
- ⑥ Attach the lens and set the POWER switch to OFF.
- The camera starts beeping if the battery pack becomes low during cleaning. Stop the cleaning immediately and set the POWER switch to OFF.

 **To keep dust from entering the camera**

- Choose a location with little dust to change the lens, and complete the operation quickly.
- Do not leave the camera without a lens or the body cap.
- When attaching the body cap, remove all the dust from the cap before placing it on the camera.

Reset default

You can reset the main functions of the camera.

- ① Select [Reset default], then press the center of the multi-selector.
The message "Reset default?" appears.
 - ② Select [OK] with ▲ on the multi-selector, then press the center of the multi-selector.
The main functions are reset.
- For details on the items to be reset, see "Reset default" (page 172).

Enjoying your computer



Connecting the camera with your computer (page 129)

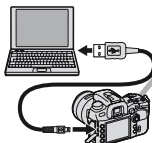

Preparing the camera and the computer, and connecting the camera and your computer

Copying images to your computer (page 130)



Viewing images on your computer

Installing the application software and utilizing images (page 135)



The following software is installed.

- “Picture Motion Browser”
- “Image Data Converter SR”
- “Image Data Lightbox SR”
- “Remote Camera Control”

Recommended computer environment

The following environment is recommended for a computer connected to the camera to import images.

■ Windows

OS (pre-installed): Microsoft Windows 2000 Professional SP4/ Windows XP* SP2/Windows Vista*

- Operation is not assured in an environment based on an upgrade of the operating systems described above or in a multi-boot environment.

* 64-bit editions and Starter (Edition) are not supported.

USB jack: Provided as standard

■ Macintosh

OS (pre-installed): Mac OS X (v10.1.3 or later)

USB jack: Provided as standard

Notes on connecting your camera to a computer

- Operations are not guaranteed for all the recommended computer environments mentioned above.
- If you connect two or more USB devices to a single computer at the same time, some devices, including your camera, may not operate, depending on the types of USB devices you are using.
- Operations are not guaranteed when using a USB hub or an extension cable.
- Connecting your camera using a USB interface that is compatible with Hi-Speed USB (USB 2.0 compliant) allows advanced transfer (high speed transfer) as this camera is compatible with Hi-Speed USB (USB 2.0 compliant).
- Check that [USB connection] in the  Setup menu is set to [Mass Storage].
- When your computer resumes from a suspend or sleep mode, communication between your camera and your computer may not recover at the same time.

Connecting the camera and your computer

You can copy images from the camera to your computer as follows.

For directly inserting the memory card in a computer

Remove the memory card from the camera and insert it in the computer and copy the images.

For connecting the camera with the memory card inserted to a computer using the USB connection

Follow the procedure on pages 130 to 132 to copy images.

- Check that [USB connection] in the  Setup menu is set to [Mass Storage] (page 124).

1 Insert a memory card with recorded images into the camera.

2 Insert the sufficiently charged battery pack in the camera, or connect the camera to a wall outlet (wall socket) with the AC Adaptor/charger (not supplied).

- When you copy images to your computer using insufficient battery pack, copying may fail or image data may become corrupted if the battery pack shut down too soon.

3 Turn on the camera and the computer.

4 Connect the camera and your computer.

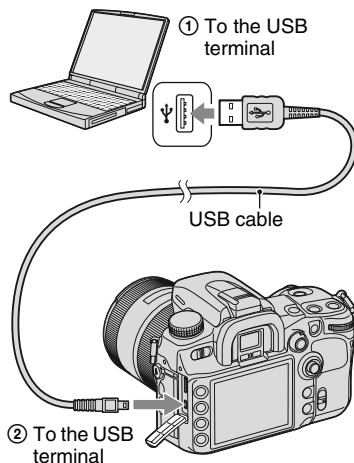

Copying images to your computer

Copying images to a computer – Windows XP/Vista

This section describes an example of copying images to a “My Documents” (For Windows Vista: “Documents”) folder.

- 1 After making a USB connection, click [Copy pictures to a folder on my computer using Microsoft Scanner and Camera Wizard] → [OK] as the wizard screen appears automatically on the desktop.

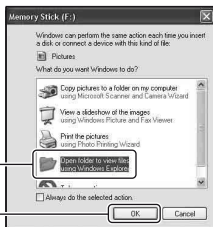

- When the wizard screen does not appear, → “Copying images to a Computer – Windows 2000” (page 131).

2 Double-click [DCIM].

- In that case, you can also import images using “Picture Motion Browser”.

- 3 Double-click the folder where the image files you want to copy are stored.

Then, right-click an image file to display the menu and click [Copy].

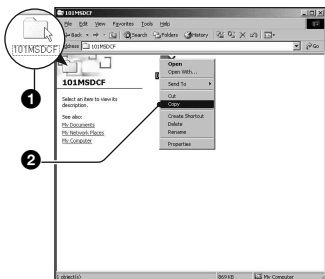

- On the storage destination of the image files, see page 133.

- 4 Double-click the [My Documents] (For Windows Vista: [Documents]) folder. Then, right-click on the “My Documents” window to display the menu and click [Paste].

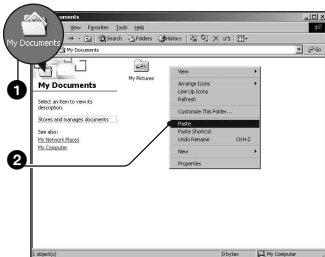

The image files are copied to the “My Documents” (For Windows Vista: “Documents”) folder.

- When an image with the same file name exists in the copy destination folder, the overwrite confirmation message appears. When you overwrite an existing image with a new one, the original file data is deleted. To copy an image file to the computer without overwriting, change the file name to a different name and then copy the image file. However, note that if you change the file name, you may not be able to play back that image with your camera (page 134).

Copying images to a Computer – Windows 2000

This section describes an example of copying images to the “My Documents” folder.

- 1 Double-click [My Computer] → [Removable Disk].
- 2 Follow the step 2 and later in “Copying images to a computer – Windows XP/Vista”.

Copying images to a Computer – Macintosh

- 1 Double-click the newly recognized icon → [DCIM] → the folder where the images you want to copy are stored.
- 2 Drag and drop the image files to the hard disk icon.

The image files are copied to the hard disk.

Viewing images on your computer

■ Windows

This section describes the procedure for viewing copied images in the “My Documents” (For Windows Vista: “Documents”) folder.

- 1 Click [Start] → [My Documents] (For Windows Vista: [Documents]).

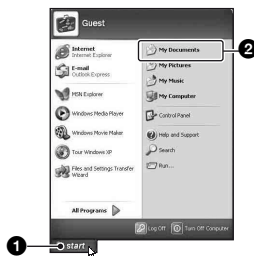

The contents of the “My Documents” (For Windows Vista: “Documents”) folder are displayed.

- If you are using Windows 2000, double-click [My Documents] on the desktop.

2 Double-click the desired image file.

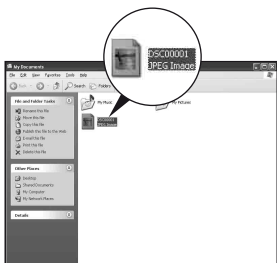

The image is displayed.

■ Macintosh

Double-click the hard disk icon → the desired image file to open that image file.

To delete the USB connection

Perform the procedures listed below beforehand when:

- Disconnecting the USB cable
- Removing the memory card
- Turning off the camera

■ Windows

- ① Double-click  on the tasktray.



Double-click here

- ② Click  (USB Mass Storage Device) → [Stop].
- ③ Confirm the device on the confirmation window, then click [OK].

- ④ Click [OK].

The device is disconnected.

- Step ④ is unnecessary for Windows XP/Vista.

■ Macintosh

Drag and drop the drive icon or the icon of the memory card to the “Trash” icon. The camera is disconnected from the computer.

Image file storage destinations and file names

The image files recorded with your camera are grouped as folders on the memory card.

Example: viewing folders on Windows XP

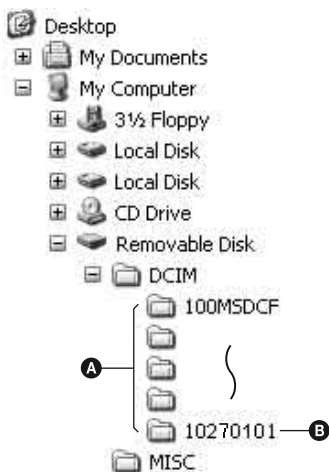

- A** Folders containing image data recorded using this camera. (The first three digits show the folder number.)
- B** You can create a folder by date form (page 123).
- You cannot record/play back any images to the “MISC” folder.
- Image files are named as follows. □□□□ (file number) stands for any number within the range from 0001 to 9999. The numerical portions of the name of a RAW data file and its corresponding JPEG image file are the same.
 - JPEG files: DSC0□□□□.JPG
 - JPEG files (Adobe RGB):
_DSC□□□□.JPG
 - RAW data file (other than Adobe RGB):
DSC0□□□□.ARW
 - RAW data file (Adobe RGB):
_DSC□□□□.ARW
- The extension may not be displayed depending on the computer.
- For more information about folders, see pages 123, 124.

Copying images stored on a computer to a memory card and viewing the images

This section describes the process using a Windows computer as an example.

When an image file copied to a computer no longer remains on a memory card, you can view that image again on the camera by copying the image file on the computer to a memory card.

- Step 1 is not necessary if the file name set with your camera has not been changed.
- You may be unable to play back some images depending on the image size.
- When an image file has been processed by a computer or when the image file was recorded using a model other than that of your camera, playback on your camera is not guaranteed.
- When there is no folder, first create a folder with your camera (page 124) and then copy the image file.

1 Right-click the image file, then click [Rename]. Change the file name to "DSC0□□□□".

Enter a number from 0001 to 9999 for □□□□.



- If the overwrite confirmation message appears, enter a different number.
- An extension may be displayed depending on the computer settings. The extension for images is JPG. Do not change the extension.

2 Copy the image file to the memory card folder in the following order.

- ① Right-click the image file, then click [Copy].
- ② Double-click [Removable Disk] or [Sony MemoryStick] in [My Computer].
- ③ Right-click the [□□□MSDCF] folder in the [DCIM] folder, then click [Paste].
 - □□□ stands for any number within the range from 100 to 999.

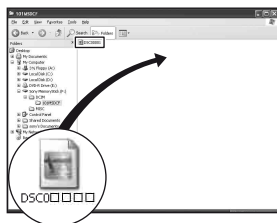

Using the software (supplied)

To utilize images recorded with the camera, the following software is provided: “Picture Motion Browser”, “Image Data Converter SR”, “Image Data Lightbox SR”, “Remote Camera Control” etc.

- “Picture Motion Browser” is not compatible with Macintosh computers.

Recommended computer environment

■ Windows

Recommended environment for using “Picture Motion Browser”

OS (pre-installed): Microsoft Windows 2000 Professional SP4/Windows XP* SP2/Windows Vista*

CPU/Memory: Pentium III 500 MHz or faster, 256 MB of RAM or more (Recommended: Pentium III 800 MHz or faster and 512 MB of RAM or more)

Hard Disk: Disk space required for installation—200 MB or more

Display: 1024 × 768 dots or more, High Color (16-bit color) or more

Recommended environment for using “Image Data Converter SR Ver.2”/ “Image Data Lightbox SR”/“Remote Camera Control”

OS (pre-installed): Microsoft Windows 2000 Professional SP4/ Windows XP* SP2/Windows Vista* (“Remote Camera Control” is only for Windows XP* SP2/Windows Vista*)

CPU/Memory: MMX Pentium III 1 GHz or faster is recommended, RAM 512 MB or more (RAM 1 GB or more is recommended.)

Virtual memory: 700 MB or more

Display: 1024 × 768 dots or more, High Color (16-bit color) or more

* 64-bit editions and Starter (Edition) are not supported.

■ Macintosh

Recommended environment for using “Image Data Converter SR Ver.2”/ “Image Data Lightbox SR”/“Remote Camera Control”

OS (pre-installed): Mac OS X (v10.4) or later

CPU: Power Mac G4/G5 series (1.0 GHz or faster is recommended)/ Intel Core Solo/ Core Duo/Core 2 Duo or faster

Memory: 512 MB or more (1 GB or more is recommended.)

Display: 1024 × 768 dots or more, 32,000 colors or more

Installing the software

You can install the software (supplied) using the following procedure.



■ Windows

- Log on as Administrator.

1 Turn on your computer, and insert the CD-ROM (supplied) into the CD-ROM drive.

The installation menu screen appears.



- If it does not appear, double-click  (My Computer) →  (SONYPICUTIL).
- Under Windows Vista, the AutoPlay screen may appear. Select “Run Install.exe” and follow the instructions that appear on the screen to proceed with the installation.

2 Click [Install].

The “Choose Setup Language” screen appears.

3 Select the desired language, then click [Next].

The [Location Settings] screen appears.

4 Select the [Region] and [Country/Area], then click [Next].

When the [Welcome to the InstallShield Wizard for SonyPicture Utility] appears, click [Next].

The “License Agreement” screen appears. Read the agreement carefully. If you accept the terms of the

agreement, click the radio button next to [I accept the terms of the license agreement] and then click [Next].

5 Follow the instructions on the screen to complete the installation.

- When the restarting confirmation message appears, restart the computer following the instructions on the screen.

6 Remove the CD-ROM after the installation is complete.

The following software is installed.

- Sony Picture Utility
“Picture Motion Browser”
- Sony Image Data Suite
“Image Data Converter SR”
“Image Data Lightbox SR”
“Remote Camera Control”

After you install the software, a shortcut icon for the customers registration website is created on the desktop.

Once you register on the website, you can get secure and useful customer support.
<http://www.sony.net/registration/di/>

■ Macintosh

- Log on as Administrator for installation.
- ① Turn on your Macintosh computer, and insert the CD-ROM (supplied) into the CD-ROM drive.
- ② Double-click the CD-ROM icon.
- ③ Copy the [SIDS_INST.pkg] file in the [MAC] folder to the hard disk icon.
- ④ Double-click the [SIDS_INST.pkg] file in the copy-to folder.
Follow the instructions on the screen to complete the installation.
- When the restarting confirmation message appears, restart the computer following the instructions on the screen.

Using the “Picture Motion Browser”

You can use images from the camera more than ever by taking advantage of the software.

This section summarizes the “Picture Motion Browser” and gives the basic instructions.

- “Picture Motion Browser” is not compatible with Macintosh computers.

“Picture Motion Browser” overview

With the “Picture Motion Browser” you can:

- Import images shot with the camera and display them on the computer.
- Organize images on the computer on a calendar by shooting date to view them.
- Retouch (Red Eye Correction, etc.), print, and send still images as e-mail attachments, change the shooting date and more.
- Still images can be printed or saved with the date.
- You can create a data disc using a CD burner drive or DVD burner drive.
- For details on the “Picture Motion Browser”, refer to the “Picture Motion Browser Guide”.

To start the “Picture Motion Browser Guide” from the Start menu, click [Start] → [All Programs] (in Windows 2000, [Programs]) → [Sony Picture Utility] → [Help] → [Picture Motion Browser Guide].

Starting and exiting the “Picture Motion Browser”

Starting the “Picture Motion Browser”

Double-click the  (Picture Motion Browser) icon on the desktop. Or, from the Start menu: Click [Start] → [All Programs] (in Windows 2000, [Programs]) → [Sony Picture Utility] → [Picture Motion Browser].

- The confirmation message of the Information tool appears on the screen when starting the

“Picture Motion Browser” for the first time. Select [Start]. This function informs you of news, such as software updates. You can change the setting later.

Exiting the “Picture Motion Browser”

Click  button in the top right corner of the screen.

Importing images

1 Connect the camera to your computer by following “Connecting the camera and your computer”.

After the camera is automatically detected, the [Import Media Files] screen is displayed.



- In Windows XP/Vista, if the AutoPlay Wizard appears, close it.

2 Import the images.

To start importing images, click the [Import] button.

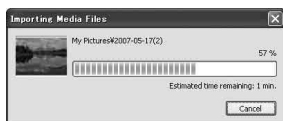

By default, images are imported into a folder created in “My Pictures” that is named with the date of importing.

- For details on the operation, refer to “Picture Motion Browser Guide”.

Viewing images

When importing is complete, the “Picture Motion Browser” starts. Thumbnails of the imported images are displayed.

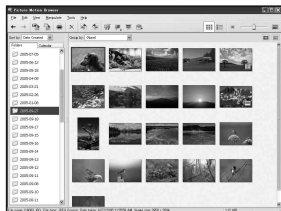

- The “My Pictures” folder is set as the default folder in “Viewed folders”.

You can view images arranged by shooting date on a calendar. For details on the operation, refer to “Picture Motion Browser Guide”.

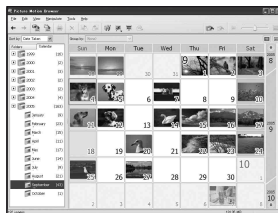

Example: Month display screen

Using the “Image Data Converter SR”

Overview of “Image Data Converter SR Ver.2.0”

Using “Image Data Converter SR Ver.2.0” you can edit images recorded in RAW mode with various corrections, such as tone curve, and sharpness. Also, you can save the images in a general-purpose file format.

- If you save an image as RAW data, the image is saved in the ARW2.0 format.
- For details, refer to the Help.

To start the Help from the Start menu, click [Start] → [All Programs] (in Windows 2000, [Programs]) → [Sony Image Data Suite] → [Help] → [Image Data Converter SR Ver.2].

Starting up or exiting “Image Data Converter SR Ver.2.0”

■ Windows To start up

Click the shortcut of “Image Data Converter SR Ver.2.0” on the desktop. When starting up from the Start menu, click [Start] → [All Programs] (For Windows 2000: [Programs]) → [Sony Image Data Suite] → [Image Data Converter SR Ver.2.0].

To exit

Click the  button on the upper-right of the screen.

■ Macintosh

To start up

Double-click [Image Data Converter SR Ver.2] in the [Sony Image Data Suite] folder from the [Application] folder.

To exit

Click [Quit Image Data Converter SR] from the [IDC SR] menu.

Adjusting the image

You can adjust the white balance, exposure, and Creative Style of the image using the buttons on the tool bar.



Saving the image

You can save the still images displayed and edited on a PC. You can either save the image as RAW data or save it in the general file format.

- For details, refer to the Help of “Image Data Converter SR”.

Technical Support

Additional information on this product and answers to frequently asked questions can be found at the Sony Customer Support Website.
<http://www.sony.net/>

Using the “Image Data Lightbox SR”

Overview of “Image Data Lightbox SR”

“Image Data Lightbox SR” allows you to do the following:

- Display and compare RAW/JPEG images recorded with this camera.
- Rate the images on a scale of five.
- Display an image in “Image Data Converter SR” and make adjustments to it.
- For details, please refer to the Help.

To start the Help from the Start menu, click [Start] → [All Programs] (in Windows 2000, [Programs]) → [Sony Image Data Suite] → [Help] → [Image Data Lightbox SR].

Starting up or exiting “Image Data Lightbox SR”

■ Windows

To start up

Double-click [Image Data Lightbox SR] on the desktop.

When starting up from the Start menu, click [Start] → [All Programs] (For Windows 2000: [Programs]) → [Sony Image Data Suite] → [Image Data Lightbox SR].

To exit

Click the  button on the upper-right of the screen.

The dialogue used for saving a collection appears. For details on a “Collection”, see page 141.

■ Macintosh

To start up

Double-click [Image Data Lightbox SR] in the [Sony Image Data Suite] folder from the [Application] folder.

To exit

Click [Quit Image Data Lightbox SR] from the [Image Data Lightbox SR] menu.

Displaying an image

When you start up, the operation menu will be displayed.

Click [Open an Image File] or [Open a Folder of Images] to display the image.

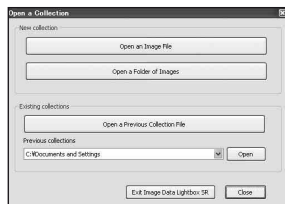

You can continue to add images by selecting [Open a Folder of Images] or [Open an Image File] from the file menu. Images in another folder can be also displayed or operated.

Comparing and prioritizing Images

You can rate the images on the screen, and identify the most important images.

1 Compare images.

You can display up to four images at a time to make comparisons.



2 Rate images.

You can attach ★ mark(s), depending on how you rate the image on a scale of five.



★ mark(s)

3 Prioritize images according to the rating.

You can rank the images by their importance and save or delete them.

Utilizing [Collection]

[Collection] is a database that manages the operation status of images in “Image Data Lightbox SR”.

You can save an operation status as it is, such as for images selected from multiple folders based on their rating information. You can resume the operation by opening a [Collection] file.

To resume an operation, start up “Image Data Lightbox SR”, click [Open a Previous Collection File], and select the desired collection file.

- For details, refer to the Help of “Image Data Lightbox SR”.

Using the “Remote Camera Control”

Overview of “Remote Camera Control”

When the camera is connected to a PC, you can use “Remote Camera Control” to take pictures or change settings on the camera from the PC.

You can also save recorded images directly on the PC.

- For details, refer to the Help.

To start the Help from the Start menu, click [Start] → [All Programs] → [Sony Image Data Suite] → [Help] → [Remote Camera Control].

Starting up or exiting “Remote Camera Control”

■ Windows

To start up

Click [Start] → [All Programs] → [Sony Image Data Suite] → [Remote Camera Control].

To exit

Click the  button on the upper-right of the screen.

■ Macintosh

To start up

Double-click [Remote Camera Control] in the [Sony Image Data Suite] folder from the [Application] folder.

To exit

Click [Quit Remote Camera Control] from the [Remote Camera Control] menu.

Setting the camera

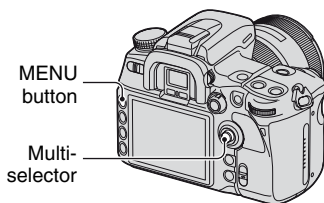

1 Press MENU to display the menu.

2 Select  (Setup) → [2] → [USB connection] with the multi-selector (page 32).

3 Select [Remote PC] with ▲/▼, then press the center of the multi-selector.

The USB mode is set to [Remote PC].

4 Turn the camera off.

Operating the camera from a computer

1 Connect the camera and your computer using the USB cable.

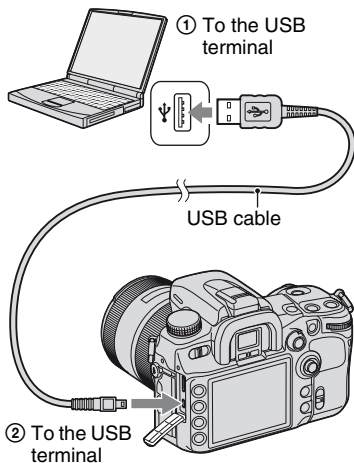

- Use the fully charged battery pack or the AC Adaptor/charger (not supplied).

2 Turn on the camera and the computer, then start the “Remote Camera Control”.



3 Make settings on the control panel, such as those for drive mode, white balance, etc.

4 Adjust the focus and click the (Shutter) button.

The camera shoots a subject and the image is stored on the computer.

- For details on the operation, refer to the help of “Remote Camera Control”.

Saving images recorded with the camera on a computer

- 1 Perform steps 1 and 2 in “Operating the camera from a computer”.**
-

- 2 Set up the camera or the computer and take a picture with the camera.**

The image is shot and is saved on the computer.

How to print images

Printing directly using a PictBridge compliant printer (page 146)



You can print images by connecting the camera directly to a PictBridge compliant printer.

Printing directly using a “Memory Stick Duo”/CF card/Microdrive compliant printer



You can print images with a “Memory Stick Duo”/CF card/Microdrive compliant printer. For details, see the operating instructions supplied with the printer.

Printing using a computer



You can copy images to a computer using the supplied “Picture Motion Browser” software and print the images. For details, see the “Picture Motion Browser Guide”.

Printing at a shop

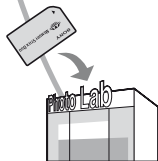

You can take a memory card containing images shot with your camera to a photo printing service shop. You can make a DPOF mark on images that you want to print out in advance.

Printing images directly using a PictBridge compliant printer

Even if you do not have a computer, you can print images shot using your camera by connecting the camera directly to a PictBridge compliant printer.

PictBridge

- “PictBridge” is based on the CIPA standard. (CIPA: Camera & Imaging Products Association)
- You cannot print RAW data files.

Stage 1: Setting the camera

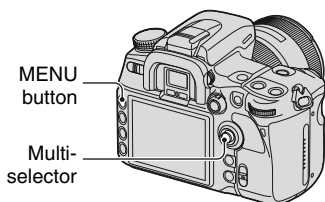

- It is recommended to use the AC Adaptor/charger (not supplied) to prevent the power from turning off partway through printing.

1 Press MENU to display the menu.

2 Select \curvearrowright (Setup) → [2] → [USB connection] with the multi-selector (page 32).

3 Select [PTP] with $\blacktriangle/\blacktriangledown$, then press the center of the multi-selector. The USB mode is set to [PTP].

4 Turn the camera off and insert the memory card that the images have been recorded.

Stage 2: Connecting the camera to the printer

1 Connect the camera to the printer.

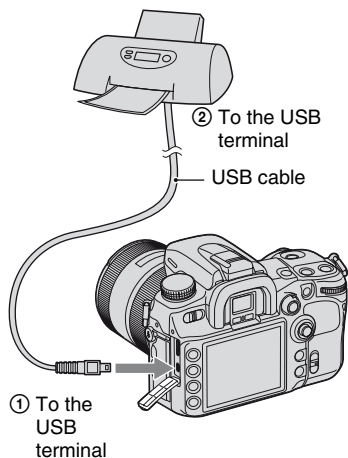

2 Turn on your camera and the printer.

The following screen appears.

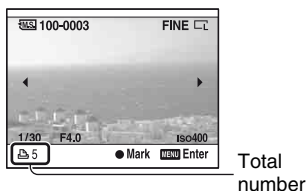

Stage 3: Printing

- 1 Select the image to print with ◀▶ on the multi-selector, then press the center.

- To cancel, press the center again.

- 2 Repeat step 1 if you want to print other images.

- 3 Press the MENU button and set up each item.

For details on setting items, see “PictBridge menu”.

- 4 Select “Print”, then press the center of the multi-selector.

The message “Print images?” appears.

- 5 Select [OK] with ▲ on the multi-selector, then press the center.

The image is printed.

- 6 After the message “Printing finished” appears, press the center of the multi-selector.

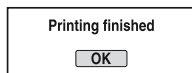

To cancel the print

During printing, pressing the center of the multi-selector cancels the print. Remove the USB cable or turn off the camera. When

you want to print again, follow the procedure (Stages 1 to 3) above.

PictBridge menu

Page 1

Print

Prints the selected images. For details, see “Stage 3: Printing”.

Set print q'ty

You can specify the number of prints, up to 20. The same number of prints is specified on all the selected images.

Paper size

<input checked="" type="checkbox"/> Auto	Printer setup
9×13cm/3.5"×5"	89×127mm
Hagaki	100×147mm
10×15cm	10×15cm
4"×6"	101.6×152.4mm
A6/4.1"×5.8"	105×148.5mm
13×18cm/5"×7"	127×178mm
Letter	216×279.4mm
A4/8.3"×11.7"	210×297mm
A3/11.7"×16.5"	297×420mm

Layout

<input checked="" type="checkbox"/>	Auto	Printer setup
	1-up/Borderless	Borderless, 1 image/sheet
	1-up	1 image/sheet
	2-up	2 images/sheet
	3-up	3 images/sheet
	4-up	4 images/sheet
	8-up	8 images/sheet
	Index	Prints all the selected images as an index print. Printing layout follows the printer setup.

Date imprint

<input checked="" type="checkbox"/>	Day and time	Attaches the date and time.
	Date	Attaches the date.
	Off	Does not attach the date.

Page 2

Unmark all

The message “Cancel all?” appears. Select [OK], then press the center of the multi-selector. The DPOF mark on each image is cleared. When you cancel your specification without printing images, select this item.

Folder print

Prints all the images in a folder. Select the folder with ▲/▼ on the multi-selector, then press the center of the multi-selector. The message “Print images?” appears. Select [OK], then press the center of the multi-selector.

Printing with the Remote Commander (supplied)

Once you connect the camera to an HDTV with an HDMI cable (not supplied), you can easily print images while viewing them on the TV.

1 Connect the camera to a TV (page 90).

2 Connect the camera to a printer (page 146).

3 Display the image you want to print.

4 Press the PRINT button on the Remote Commander.

- Depending on the menu setup of the camera, setup for printing is fixed as follows:
 - The number of sheets: 1 sheet
 - Paper size: Auto
 - Layout: Auto
 - Date imprint: Off
- When the camera is connected to a TV with the video cable (supplied), the PRINT button is disabled.

Troubleshooting

If you experience trouble with your camera, try the following solutions. Check the items on pages 149 to 157. Consult your Sony dealer or local authorized Sony service facility.

Battery pack and power

The battery pack cannot be installed.

- As you insert the battery pack, use the tip of the battery pack to push the lock lever (→ *step 1* in “*Read This First*”).

Cannot turn on the camera.

- Install the battery pack correctly (→ *step 1* in “*Read This First*”).
- The battery pack is discharged. Install a charged battery pack (→ *step 1* in “*Read This First*”).
- The battery pack is dead (page 163). Replace it with new one.

The power turns off suddenly.

- If you do not operate the camera for given period of time, the camera turns to power saving mode and nearly shuts down. To cancel the power save, operate the camera, such as pressing the shutter button halfway down (→ *step 4* in “*Read This First*”).
- The battery pack is discharged (page 163). Install a charged battery pack (→ *step 1* in “*Read This First*”).

The battery remaining indicator is incorrect, or sufficient battery remaining indicator is displayed but the power runs out too quickly.

- This phenomenon occurs when you use the camera in an extremely hot or cold location (page 163).
- The displayed battery remaining differs from the current one. Fully discharge and then charge the battery pack to correct the display.
- The battery pack is dead (page 163). Replace it with new one.

Shooting images

Nothing is displayed on the LCD monitor when the power is turned on.

- In the default setting, the LCD monitor will turn off if no operation is registered for more than five seconds to minimize the battery consumption. You can change the time setting (page 120).
- The LCD monitor is set to off. Press the DISP (Display) button to turn the LCD monitor on (page 23).

The image is not clear in the viewfinder.

- Adjust the diopter scale properly using the diopter-adjustment dial (→ *step 5* in “*Read This First*”).

The image has not been recorded.

- A memory card is not inserted.

The shutter does not release.

- Check the free capacity of the memory card (page 24). If it is full, do one of the following:
 - Delete unnecessary images (→ *step 6 in “Read This First”*).
 - Change the memory card.
- You cannot record images while charging the built-in flash (→ *step 5 in “Read This First”*).
- The shutter cannot be released when the subject is out of focus. (The shutter lock can be deactivated (page 102).)
- The shutter cannot be released when the camera is attached to another device, such as an astronomical telescope, etc. (The shutter lock can be deactivated in this situation (page 109).)
- The shutter cannot be released with “----” flashing at the lower-right corner on the LCD monitor and “0” flashing in the viewfinder. This indication means a memory card is not inserted in the camera or an incorrect type of memory card is selected. Select your memory card type with [Memory card] in the  Setup menu, then insert your memory card into the camera (→ *step 3 in “Read This First”*, page 123).
- The shutter cannot be released with “--” lit at the upper-right corner on the LCD monitor. This indication means the lens is not attached properly. Attach the lens properly (→ *step 2 in “Read This First”*).

Recording takes a long time.

- The noise reduction function is activated (page 103). This is not a malfunction.
- You are shooting in RAW mode (page 96). Since the RAW data file is large, the RAW mode shooting may take time.

The image is out of focus.

- The subject is too close. Check the minimum focal distance of the lens.
- You are shooting in manual focus mode, set to auto focus mode with the focus mode lever (page 52).
- You try to shoot a subject that may require special focusing (page 50). Use the focus-lock or manual focus function (pages 51, 53).

The flash does not work.

- The built-in flash is closed. Pull it up.
- The flash mode is set to [Autoflash]. If you want to make sure the flash fires without fail, set the flash mode to [Fill-flash] (page 73).

Fuzzy specks appear in images shot using the flash.

- Dust in the air reflected the flash light and appeared in the image. This is not a malfunction.

A picture taken with the flash is too dark.

- If the subject is beyond the flash range (the distance that the flash can reach), the pictures will be dark because the flash light does not reach the subject. If the ISO is changed, the flash range also changes with it (page 64).

The bottom of a picture taken with the flash is too dark.

- The picture was taken with the lens hood on. Remove the lens hood when the built-in flash is used. With some lenses, the bottom of the picture may become dark even without the lens hood (→ *step 5 in “Read This First”*).

The flash takes too long to recharge.

- The flash has been fired in succession in a short period. When the flash has been fired in succession, the recharging process may take longer than usual to avoid overheating of the camera.

The date and time are recorded incorrectly.

- Set the correct date and time (page 122, → *step 4 in “Read This First”*).

The aperture value and/or shutter speed flash when you press the shutter button halfway down.

- Since the subject is too bright or too dark, it is beyond the available range. Adjust the setting again.

Excessive light appears in the image.

- The picture was taken under a strong light source, and excessive light has entered the lens. Attach a lens hood.

The corners of the picture are too dark.

- If any filter or hood is used, take it off and try shooting again. Depending on the thickness of the filter and improper attachment of the hood, the filter or the hood may partially appear in the image. The optical properties of some lenses may cause the periphery of the image to appear too dark (insufficient light).

The eyes of the subject come out red.

- Activate the red eye reduction function (page 110).
- Get close to the subject, and shoot the subject within the flash range using the flash (page 65).

Dots appear and remain on the screen.

- This is not a malfunction. These dots are not recorded (page 8).

The image is blurred.

- The picture was taken in a dark location without the flash, resulting in camera-shake. The use of the Super SteadyShot function or a tripod is recommended. The flash can be used in this situation (→ *step 5 in “Read This First”*).
- The picture of the subject was taken at a very short distance, such as in macro shooting. The Super SteadyShot function may not be fully effective when the subject is very near. In such a case, turn off the Super SteadyShot function and consider using a tripod (→ *step 5 in “Read This First”*).
- The subject was moving quickly. Select a higher shutter speed or a higher ISO sensitivity (the higher the ISO sensitivity, the noisier the image).

The EV scale ◀ ▶ is flashing in the viewfinder.

- The subject is too bright or too dark for the metering range of the camera.

Viewing images

Refer to “Computers” (page 153) in conjunction with the following items.

Your camera cannot play back images.

- The folder/file name has been changed on your computer (page 134).
- When an image file has been processed by a computer or when the image file was recorded using a model other than that of your camera, playback on your camera is not guaranteed.
- The camera is in USB mode. Delete the USB connection (page 132).

The image does not appear on the TV screen.

- Check [Video output] to see if the video output signal of your camera is set to the color system of your TV (page 121).
- Check whether the connection is correct (page 89).
- If a USB cable is connected to the camera, disconnect the USB cable (page 132).

Deleting/Editing images

Your camera cannot delete an image.

- Cancel the protection (page 115).

You have deleted an image by mistake.

- Once you have deleted an image, you cannot restore it. We recommend that you protect images (page 115).

You cannot mark a DPOF mark.

- You cannot mark DPOF marks on RAW data files.

Computers

You do not know if the OS of your computer is compatible with the camera.

- Check “Recommended computer environment” (pages 128, 135).

Your computer does not recognize your camera.

- Turn on the camera.
- When the battery level is low, install the charged battery pack (→ *step 1* in “*Read This First*”), or use the AC Adaptor/charger (not supplied) (page 165).
- Use the USB cable (supplied) (page 129).
- Disconnect the USB cable, and connect it again firmly.
- Set [USB connection] to [Mass Storage] (page 124).
- Disconnect all equipment other than the camera, the keyboard and the mouse from the USB jacks of your computer.
- Connect the camera directly to your computer without passing through a USB hub or other device (page 129).

You cannot copy images.

- When you are copying images from the camera to your computer, if you open the memory card cover, the copy is canceled. Do not open the memory card cover during copying.
- Make the USB connection by properly connecting the camera with your computer (page 129).
- Follow the designated copy procedure for your OS (pages 130, 131).
- When you shoot images with a memory card formatted by a computer, you may not be able to copy the images to a computer. Shoot using a memory card formatted by your camera (page 115).

The image cannot be played back on a computer.

- If you are using “Picture Motion Browser”, refer to the “Picture Motion Browser Guide”.
- Consult the computer or software manufacturer.

After making a USB connection, “Picture Motion Browser” does not start automatically.

- Make the USB connection after the computer is turned on (page 129).

You do not know how to operate the software (supplied).

- See the help or the guide of each software.

Memory card

Cannot insert a memory card.

- Insertion direction of the memory card is wrong. Insert it in the correct direction (→ *step 3 in “Read This First”*).

Cannot record on a memory card.

- The memory card is full. Delete unnecessary images (page 114, → *step 6 in “Read This First”*).
- An unusable memory card is inserted (→ *step 3 in “Read This First”*).
- You are using the memory card with the write-protect switch, and the switch is set to the LOCK position. Set the switch to the recording position.

The Microdrive is heated.

- You are using the Microdrive for a long time. This is not a malfunction.

You have formatted a memory card by mistake.

- All the data on the memory card is deleted by formatting. You cannot restore it.

“Memory Stick PRO Duo” is not recognized by a computer with a “Memory Stick” slot.

- If “Memory Stick PRO Duo” is not supported, connect the camera to the computer (page 129). The computer recognizes the “Memory Stick PRO Duo”.

Remote Commander

The supplied Remote Commander does not function.

- To shoot, set the drive mode to  [Remote Commander]. To play back, connect the camera to a TV.
- Insert a battery into the battery holder with the +/- polarities correctly matching the +/- marks.
- Remove any obstructions between the Remote Commander and the remote sensor.
- Point the remote sensor away from strong light sources such as direct sunlight or overhead lighting. Otherwise, the Remote Commander may not function properly.
- A lens or hood may cover the remote sensor to protect it from the light. Operate the Remote Commander from positions where the light from the Remote Commander is not obscured.

Another DVD device malfunctions when you use the supplied Remote Commander.

- Select a commander mode other than DVD 2 for your DVD device, or cover the sensor of your DVD device with black paper.

Printing

Also see “PictBridge compliant printer” (as follows) in conjunction with the following items.

The color of the image is strange.

- When you print the images recorded in Adobe RGB mode using sRGB printers that are not compatible with Adobe RGB (DCF2.0/Exif2.21), the images are printed at a lower intensity level (page 72).

Images are printed with both edges cut off.

- Depending on your printer, the left, right, top, and bottom edges of the image may be cut off. Especially when you print an image shot with the aspect ratio set to [16:9], the lateral end of the image may be cut off.
- When printing images using your own printer, cancel the trimming or borderless settings. Consult the printer manufacturer as to whether the printer provides these functions or not.
- When having images printed at a digital print shop, ask the shop whether they can print the images without cutting off both edges.

Cannot print images with the date.

- Using “Picture Motion Browser”, you can print images with date (page 137).
- This camera does not have a feature for superimposing dates on images. However, because the images shot with the camera include information on the recording date, you can print images with the date superimposed if the printer or the software can recognize Exif information. For compatibility with Exif information, consult the manufacturer of the printer or the software.
- When you print images at a shop, images can be printed with the date if you ask them to do so.

PictBridge compliant printer

A connection cannot be established.

- The camera cannot be connected directly to a printer that is not compliant with the PictBridge standard. Consult the printer manufacturer as to whether the printer is compliant with PictBridge or not.
- Check that the printer is turned on and can be connected to the camera.
- Set [USB connection] to [PTP] (page 124).
- Disconnect and connect the USB cable again. If an error message is indicated on the printer, refer to the operating instructions supplied with the printer.

Cannot print images.

- Check that the camera and the printer are properly connected using the USB cable.
- RAW data files cannot be printed.
- Images shot using cameras other than this camera or images modified with a computer may not be printed.

Cannot insert the date or print images in the index mode.

- The printer does not provide these functions. Consult the printer manufacturer as to whether the printer provides these functions or not.
- The date may not be superimposed in the index mode depending on the printer. Consult the printer manufacturer.

“---- -- --” is printed on the date-inserted part of the image.

- Images that do not have the recording data cannot be printed with the date inserted. Set [Date imprint] to [Off] and print the image again (page 148).

Cannot select the print size.

- Consult the printer manufacturer as to whether the printer can provide the desired size.

Cannot print the image at the size selected.

- Disconnect the USB cable and reconnect it whenever you change the paper size after the printer has been connected to the camera.
- The print setting of the camera differs from that of the printer. Change the setting of either the camera (page 147) or the printer.

Cannot operate the camera after canceling printing.

- Wait for a while as the printer is carrying out the cancellation. It may take some time depending on the printer.

Others

The lens gets fogged.

- Moisture condensation has occurred. Turn off the camera and leave it for about an hour before using it (page 168).

The message “Set date and time?” appears when you turn on the camera.

- The camera has been left unused for sometime with a low battery or no battery pack. Charge the battery pack and set the date again (→ *step 4 in “Read This First”*). If the date setting is lost every time the battery pack is charged, consult your Sony dealer or local authorized Sony service facility.

The number of recordable images does not decrease or decreases two at a time.

- This is because the compression rate and the image size after compression change depending on the image when you shoot with a JPEG image (page 96).

The setting is reset without the resetting operation.

- The battery pack was removed when the POWER switch was set to ON. When removing the battery pack, make sure the POWER switch is set to OFF and the access lamp is not illuminated (→ *step 1 in "Read This First"*).

The camera does not work properly.

- Turn off the camera. Remove the battery pack and insert it again. If an AC Adaptor/charger (not supplied) is used, disconnect the power cord. If the camera is hot, allow it to cool down before trying this corrective procedure.

The five bars of the Super SteadyShot scale flash.

- The Super SteadyShot function does not work. You can continue to shoot but the Super SteadyShot function will not work. Turn the camera off and on. If the Super SteadyShot scale continues to flash, consult your Sony dealer or local authorized Sony service facility.

"--E-" is indicated on the lower-right corner of the LCD monitor.

- Remove the memory card, and insert it again. If this procedure does not turn off the indication, format the memory card.

Warning messages

If the following messages appear, follow the instructions.

For “InfoLITHIUM” battery only

- An incompatible battery pack is being used.

Battery exhausted

- The battery pack is discharged. Charge the battery pack.

Set date and time?

- Set the date and time. If the message appears frequently, the internal backup battery is used up. Replace the battery (pages 156, 169).

Power insufficient

- You tried to perform [Cleaning mode] when the battery level is insufficient. Charge the battery pack or use the AC Adaptor/charger (not supplied).

No Memory Stick No CF card

- The type of the memory card inserted into the camera is different from the memory card type selected with [Memory card] in the  Setup menu. Set it to appropriate position.

Unable to use Memory Stick. Format?

Unable to use CF card. Format?

- The memory card was formatted on a computer and the file format was modified, or the memory card was formatted on another device. Select [OK], then format the memory card. You can use the memory card again, however, all previous data in the memory card is erased. It may take a some time to complete the format. If the message still appears, change the memory card.

Card error

- An incompatible memory card is inserted or the format was failed.

Read only memory

- Your camera cannot record or delete images on this “Memory Stick Duo”.

Reinsert the Memory Stick. Reinsert the CF card.

- The inserted memory card cannot be used in your camera.
- The memory card is damaged.
- The terminal section of the memory card is dirty.

Use Memory Stick slot to format.

- You attempt to format the “Memory Stick Duo” that is inserted into the CF card insertion slot using an adaptor. Insert the “Memory Stick Duo” into the “Memory Stick Duo” insertion slot and format it.

Processing...

- When Long exposure noise reduction will be done for the same amount of time that the shutter was open. You cannot do any further shooting during this reduction.

No Memory Stick inserted. Shutter is locked.

No CF card inserted. Shutter is locked.

- [Release w/oCard] is set to [Disable]. Set it to [Enable] or insert a memory card.

No lens attached. Shutter is locked.

- [Release w/oLens] is set to [Disable]. Attach a lens. When attaching the camera to an astronomical telescope or something similar, set it to [Enable] in the  Custom menu.

Unable to display.

- Images recorded with other cameras or images modified with a computer may not be able to be displayed.

No images

- There is no image in the memory card.

Image protected

- You tried to delete protected images. Release the protection.

Unable to print.

- You tried to mark RAW images with a DPOF mark.

Initializing USB connection...

- A USB connection has been established. Do not disconnect the USB cable.

Check the connected device.

- A PictBridge connection cannot be established. Disconnect the USB cable and connect it again.

Camera overheating. Allow it to cool.

- The camera has become hot because you have been shooting continuously. Turn the power off. Cool the camera and wait until the camera is ready to shoot again.

**Camera error
System error**

- Turn the power off, remove the battery pack, then re-insert it. If the message appears frequently, consult your Sony dealer or local authorized Sony service facility.

Cover open

- Close the memory card cover to start shooting.
- Check that the access lamp is not lit, then open the cover when you replace the memory card.

**Unable to magnify.
Unable to rotate image.**

- Images recorded with other cameras may not be enlarged or rotated.

No images changed

- You attempted to protect images or specified DPOF without changing the specification of those images.

Cannot create more folders.

- The folder with a name beginning with "999" exists on the memory card. You cannot create any folders if this is the case.

Printing canceled

- The print job was canceled. Disconnect the USB cable or turn the camera off.

Unable to mark.

- You attempted to mark RAW images on the PictBridge screen.

No printable image

- You attempted to print images from a folder that has no images when [Folder print] was selected.

Printer error

- Check the printer.
- Check if the image you want to print is corrupted.

Printer busy

- Check the printer.

On the memory card (not supplied)

On the “Memory Stick Duo”

A “Memory Stick Duo” is a compact, portable IC recording medium. The types of “Memory Stick Duo” that can be used with this camera are listed in the table below. However, proper operation cannot be guaranteed for all “Memory Stick Duo” functions.

“Memory Stick” type	Recording/ Playback
Memory Stick Duo (without MagicGate)	○
Memory Stick Duo (with MagicGate)	○ ^{*1} *2
MagicGate Memory Stick Duo	○ ^{*1}
Memory Stick PRO Duo	○ ^{*1} *2
Memory Stick PRO-HG Duo	○ ^{*1} *2

^{*1} This is equipped with MagicGate function. MagicGate is copyright protection technology that uses encryption technology. Data recording/playback that requires MagicGate functions cannot be performed with this camera.

^{*2} Supports high-speed data transfer using a parallel interface.

- A “Memory Stick Duo” formatted with a computer is not guaranteed to operate with this camera.
- Data read/write speeds differ depending on the combination of the “Memory Stick Duo” and the equipment used.

Notes on using a “Memory Stick Duo”

- Do not remove the “Memory Stick Duo” while reading or writing data.
- Data may be corrupted in the following cases:
 - When the “Memory Stick Duo” is removed or the camera is turned off during a read or write operation
 - When the “Memory Stick Duo” is used in locations subject to static electricity or electrical noise
- We recommend backing up important data.
- Do not press down hard when you write down on the memo area.
- Do not attach a label on the “Memory Stick Duo” itself.
- When you carry or store the “Memory Stick Duo”, put it in the case supplied with it.
- Do not touch the terminal section of the “Memory Stick Duo” with your hand or a metal object.
- Do not strike, bend or drop the “Memory Stick Duo”.
- Do not disassemble or modify the “Memory Stick Duo”.
- Do not expose the “Memory Stick Duo” to water.
- Do not leave the “Memory Stick Duo” within the reach of small children. They might accidentally swallow it.
- Do not insert any object other than a “Memory Stick Duo” into the “Memory Stick Duo” insertion slot. It may cause a malfunction.
- Do not use or store the “Memory Stick Duo” under the following conditions:
 - High temperature locations such as the hot interior of a car parked in direct sunlight
 - Locations exposed to direct sunlight
 - Humid locations or locations with corrosive substances present

Note on using “Memory Stick PRO Duo”

“Memory Stick PRO Duo” or “Memory Stick PRO-HG Duo” with a capacity up to 8 GB have been confirmed to operate properly with this camera.

Notes on using “Memory Stick Micro”

- To use a “Memory Stick Micro” with this camera, be sure to insert the “Memory Stick Micro” into an “M2” Adaptor as large as of Duo size. If you insert a “Memory Stick Micro” into the camera without an “M2” Adaptor as large as of Duo size, you might not be able to remove it from the camera.
- Do not leave the “Memory Stick Micro” within the reach of small children. They might accidentally swallow it.

On the CF card/Microdrive

- Be sure to format the recording medium using this camera when you use it for the first time.
- Data may be damaged in the following cases:
 - Removing the memory card while reading or writing data.
 - If you store the memory card near strongly-magnetized material.
- The memory card may be hot just after it has been used. Be careful when you handle it.
- Do not remove the label or attach a new label over the label.
- When you carry or store the memory card, put it in the case supplied with it.
- Do not expose the memory card to water.
- Do not press on the label strongly.
- Do not touch the terminal section of the memory card with your hand or a metal object.

Notes on use of the Microdrive

A Microdrive is a compact and lightweight hard disk drive that complies with CompactFlash Type II.

- The Microdrive is a compact hard disk drive. Since the Microdrive is a rotating disk, the Microdrive is not strong enough to resist vibration and shock compared to a “Memory Stick”, which uses flash memory. Be sure not to transmit vibration or shock to the Microdrive during playback or shooting.
- Note that the use of the Microdrive under 5°C (41°F) may bring performance degradation. Operating temperature range when using the Microdrive: 5 to 40°C (41 to 104°F)
- Note that the Microdrive cannot be used under low atmospheric pressure (above 3 000 meters above sea-level).
- Do not write on the label.

On the “InfoLITHIUM” battery pack

Use only an NP-FM500H battery pack.

What is an “InfoLITHIUM” battery pack?

An “InfoLITHIUM” battery pack is a lithium-ion battery pack that has functions for exchanging information related to operating conditions with your camera. Using the “InfoLITHIUM” battery pack, the remaining battery time in percent figures is displayed according to the operating conditions of your camera.

On charging the battery pack

We recommend charging the battery pack in an ambient temperature of between 10 to 30°C (50 to 86°F). You may not be able to efficiently charge the battery pack outside of this temperature range.

Effective use of the battery pack

- Battery performance decreases in low temperature surroundings. So, the time that the battery pack can be used is shorter in cold places. We recommend the following to ensure longer battery pack use:
 - Put the battery pack in a pocket close to your body to warm it up, and insert it in your camera immediately before you start shooting.
- The battery pack will run out quickly if you use the flash frequently.
- We recommend having spare battery packs handy, and making trial shots before taking the actual shots.
- Do not expose the battery pack to water. The battery pack is not water-resistant.
- Do not leave the battery pack in extremely hot places, such as in a car or under direct sunlight.

On the remaining battery indicator

The power may go off although the battery remaining indicator shows there is enough power to operate. Use the battery pack up and charge the battery pack fully again so that the indication on the battery remaining indicator is correct. Note, however, that the correct battery indication sometimes will not be restored if the battery pack is used in high temperatures for a long time, left in a fully charged state or used frequently.

How to store the battery pack

If the battery pack is not to be used for a long time, fully charge it and then fully use it up once a year on your camera before storing the battery pack in a dry, cool place. Repeat this charging and using up once a year to maintain the battery pack’s function.

On battery life

- The battery life is limited. Battery capacity decreases little by little as you use it more and more, and as time passes. If the battery operating time seems shortened considerably, a probable cause is that the battery pack has reached the end of its life. Buy a new battery pack.
- The battery life varies according to how it is stored and the operating conditions and environment in which each battery pack is used.

On the battery charger

On the battery charger

- Do not charge any battery pack other than the “InfoLITHIUM” M series battery pack in the battery charger (supplied) with your camera. Batteries other than the specified kind may leak, overheat, or explode if you attempt to charge them, posing a risk of injury from electrocution and burns.
- Remove the charged battery pack from the battery charger. If you leave the charged battery pack in the charger, battery life may be decreased.
- When the CHARGE lamp flashes, this may indicate a battery error or that a battery pack other than the specified type have been inserted. Check that the battery pack is the specified type. If the battery pack is the specified type, remove the battery pack, replace it with new one or another one and check if the battery charger operates correctly. If the battery charger operates correctly, a battery error may have occurred.
- If the battery charger is dirty, charging may not be performed successfully. Clean the battery charger with dry cloth, etc.

Optional accessories

This section introduces how to connect and operate popular accessories for this camera. For details, refer to the operating instructions of each of the accessories.

AC-VQ900AM AC Adaptor/charger

When a household power outlet (AC power) is available, using an AC Adaptor/charger eliminates the possibility of running out of battery.

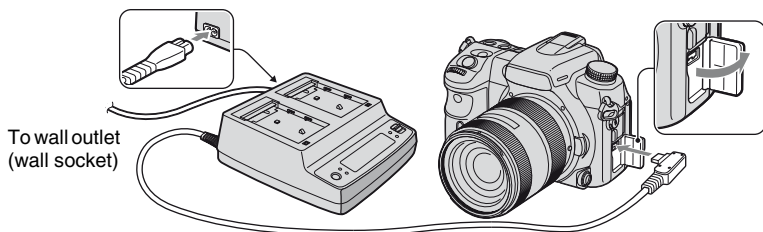

To connect the adaptor, set the POWER switch of the camera to OFF, flip open the cover, and insert the plug of the AC Adaptor/charger into the DC IN terminal.

- When disconnecting the AC Adaptor/charger from the camera, turn the power off beforehand.
- You cannot use any AC adaptor/charger other than the AC-VQ900AM.

VG-C70AM Vertical Grip

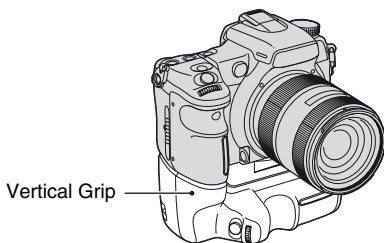

The Vertical Grip is equipped with a portrait shooting shutter button and a power switch, as well as front and rear control dials and an AEL (AE lock) button, which allows you to operate the camera the same way as in the landscape position. The Vertical Grip can accept either one or two of the battery pack(s), NP-FM500H, used with this camera.

RM-S1AM Remote Commander

This Remote Commander allows you to release the shutter without touching the camera. This keeps the camera from shaking. In addition, you can keep the shutter button down during bulb exposure (page 43).

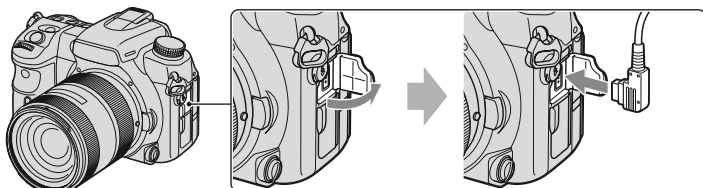

To attach the Remote Commander, flip open the cover of the REMOTE terminal and insert the plug of the Remote Commander.

With the Remote Commander clip attached to the shoulder strap, you can catch the cord to secure it.

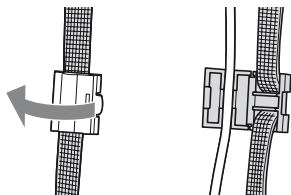

HVL-F56AM/HVL-F36AM Flash

A powerful flash can cover a longer distance than the built-in flash can, enabling flash shooting that produces beautiful images.

Flash HVL-F56AM

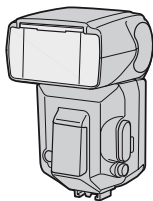

When using the flash (not supplied), remove the accessory shoe cap and slide the flash onto the camera. The removed cap can be placed on the eyepiece cover.



High Speed Sync (HSS) Shooting

Although a high shutter speed cannot be used in normal flash recording, the HVL-F56AM or HVL-F36AM flash allows you to take pictures using the flash with any shutter speed, including a high speed. It also enables you to take pictures with the flash in bright conditions with the iris open.

- In high speed sync mode, “H” or “HSS” appears in the viewfinder and on the LCD monitor.
- High speed sync mode is not available when the two-second self-timer or [Rear sync.] is selected.

FDA-A1AM Angle Finder/FDA-M1AM Magnifier

When using the Angle Finder or Magnifier, remove the eyecup.

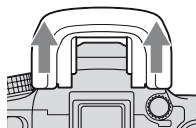

Precautions

■ Do not use/store the camera in the following places

- In an extremely hot, dry or humid place
In places such as in a car parked in the sun, the camera body may become deformed and this may cause a malfunction.
- Under direct sunlight or near a heater
The camera body may become discolored or deformed, and this may cause a malfunction.
- In a location subject to rocking vibration
- Near strong magnetic place
- In sandy or dusty places
Be careful not to let sand or dust get into the camera. This may cause the camera to malfunction, and in some cases this malfunction cannot be repaired.

■ On carrying

Be sure to attach the lens cap or body cap when not using the camera. When attaching the body cap, remove all the dust from the cap before placing it on the camera.

■ On cleaning

Cleaning the LCD monitor

Wipe the screen surface with an LCD cleaning kit (not supplied) to remove fingerprints, dust, etc.

Cleaning the lens

- When cleaning the lens surface, remove dust using a blower. In case of dust that sticks to the surface, wipe it off with a soft cloth or tissue paper slightly moistened with lens cleaning solution. Wipe in a spiral pattern from the center to the outside. Do not spray lens cleaning solution directly onto the lens surface.
- Do not touch the inside of the camera, such as lens contacts, or the mirror. Since dust on the mirror or around the mirror may affect the auto focus system, blow away dust using a blower. If dust lands on the image sensor, it may appear on the photo image. Turn the camera to the cleaning mode (page 125), then clean it using a blower. Do not use a spray blower to clean the inside of the camera. Using this may cause a malfunction.
- Do not use a cleaning solution containing organic solvents, such as thinner, or benzene.

Cleaning the camera surface

Clean the camera surface with a soft cloth slightly moistened with water, then wipe the surface with a dry cloth. Do not use the following as they may damage the finish or the casing.

- Chemical products such as thinner, benzene, alcohol, disposable cloths, insect repellent, sunscreen or insecticide, etc.
- Do not touch the camera with the above on your hand.
- Do not leave the camera in contact with rubber or vinyl for a long time.

■ On operating temperatures

Your camera is designed for use under the temperatures between 0 and 40°C (32 and 104°F) (When using a Microdrive: 5 and 40°C (41 and 104°F)). Shooting in extremely cold or hot places that exceed this range is not recommended.

■ On moisture condensation

If the camera is brought directly from a cold to a warm location, moisture may condense inside or outside the camera. This moisture condensation may cause a malfunction of the camera.

How to prevent moisture condensation

When bringing the camera from a cold place to a warm place, seal the camera in a plastic bag and allow it to adapt to conditions at the new location over about an hour.

If moisture condensation occurs

Turn off the camera and wait about an hour for the moisture to evaporate. Note that if you attempt to shoot with moisture remaining inside the lens, you will be unable to record clear images.

■ On the internal rechargeable battery

This camera has an internal rechargeable battery for maintaining the date and time and other settings regardless of whether the power is on or off.

This rechargeable battery is continually charged as long as you are using the camera. However, if you use the camera for only short periods, it discharges gradually, and if you do not use the camera at all for about 8 months it becomes completely discharged. In this case, be sure to charge this rechargeable battery before using the camera.

However, even if this rechargeable battery is not charged, you can still use the camera as long as you do not record the date and time.

Charging method of the internal rechargeable battery

Insert a charged battery pack in the camera, or connect the camera to a wall outlet (wall socket) using the AC Adaptor/charger (not supplied), and leave the camera for 24 hours or more with the power off.

Charging method of the NP-FM500H battery pack

→ *step 1 in "Read This First"*

For Customers in Europe

Disposal of waste batteries (applicable in the European Union and other European countries with separate collection systems)



This symbol on the battery or on the packaging indicates that the battery provided with this product shall not be treated as household waste.

By ensuring these batteries are disposed of correctly, you will help prevent potentially negative consequences for the environment and human health which could otherwise be caused by inappropriate waste handling of the battery. The recycling of the materials will help to conserve natural resources.

In case of products that for safety, performance or data integrity reasons require a permanent connection with an incorporated battery, this battery should be replaced by qualified service staff only.

To ensure that the battery will be treated properly, hand over the product at end-of-life to the applicable collection point for the recycling of electrical and electronic equipment.

For all other batteries, please view the section on how to remove the battery from the product safely. Hand the battery over to the applicable collection point for the recycling of waste batteries.

For more detailed information about recycling of this product or battery, please contact your local Civic Office, your household waste disposal service or the shop where you purchased the product.

Specifications

Camera

[System]

Camera Type	Digital Single Lens Reflex Camera with built-in flash and interchangeable lenses
Image format	23.5×15.6 mm (APS-C format)
Lens	All of Sony Lens

[Image sensor]

Total pixel number of camera	Approx. 13 053 000 pixels
Effective pixel number of camera	Approx. 12 246 000 pixels

[Super SteadyShot]

System	Image sensor-Shift mechanism
Super SteadyShot Compensation capability	Approximately 2.5 EV to 4 EV decrease in shutter speed (varies according to shooting conditions and lens used)

[Anti-Dust]

System	Charge protection coating on Low-Pass Filter and image sensor-Shift mechanism
--------	---

[Viewfinder]

Type	Fixed eye-level system with optical glass type pentaprism
Focusing Screen	Spherical Acute Matte
Field of View	0.95
Magnification	0.9 × with 50 mm lens at infinity, -1 m^{-1}
Eye Relief	Approximately 25 mm from the eyepiece, 21 mm from the eyepiece frame at -1 diopter (-1 m^{-1})
Diopter Adjustment	-3.0 to $+1.0 \text{ m}^{-1}$

[Auto Focus System]

System	TTL phase-detection system, CCD line sensors (Metering area 11 points)
Sensitivity Range	0 EV to +18 EV (at ISO 100 equivalent)

[Exposure]

Metering Cell	40-segment honeycomb-pattern SPC
Metering Range	0 EV to 20 EV (+2 EV to +20 EV with Spot metering), (at ISO 100 with F1.4 lens)

[Shutter]

Type	Electronically-controlled, vertical-traverse, focal-plane type
Speed range	1/8000 second to 30 seconds, bulb
Flash Sync Speed	1/250 second (with Super SteadyShot off), 1/200 second (with Super SteadyShot on)

[Built-In-Flash]

Flash G.No.	GN 12 (in meters at ISO 100)
Recycling Time	Approx. 3 seconds

[Recording media]

CompactFlash card(TypeI,II), Microdrive, "Memory Stick Duo"

[LCD monitor]

LCD panel	7.5 cm (3.0 type) TFT drive
Total number of dots	921 600 (640 ×3 (RGB) × 480) dots

[Input/output terminals]

VIDEO OUT terminal	Special multi-connector
USB terminal	Special multi-connector, Hi-speed USB (USB 2.0 compliant)
HDMI OUT terminal	HDMI type C minijack
Sync. terminal	
REMOTE terminal	
Used battery pack	Rechargeable battery pack NP-FM500H

[Others]

PictBridge	Compatible
Exif Print	Compatible
PRINT Image Matching III	Compatible
Exif	Exif Ver.2.21
RAW	ARW2.0 format
Dimensions	Approx. 141.7 × 104.8 × 79.7 mm (5 5/8 × 4 1/4 × 3 1/4 inches) (W/H/D, excluding protrusions)
Mass	Approx. 690 g (1 lb 8.3 oz) (without batteries, memory card and body accessories)
Operating temperature	0 to 40°C (32 to 104°F) (When using the Microdrive: 5 to 40°C (41 to 104°F))

BC-VM10 Battery charger

Input rating	100 V – 240 V AC, 50/60 Hz
Output rating	8.4 V DC, 750 mA
Operating temperature range	0 to 40°C (32 to 104°F)
Storage temperature range	-20 to +60°C (-4 to +140°F)
Maximum dimensions	Approx. 70 × 25 × 95 mm (2 7/8 × 1 × 3 3/4 inches) (W/H/D)
Mass	Approx. 90 g (3.2 oz)

Rechargeable battery pack NP-FM500H

Used battery	Lithium-ion battery
Maximum voltage	DC 8.4 V
Nominal voltage	DC 7.2 V
Maximum charge current	2.0 A
Maximum charge voltage	DC 8.4 V
Capacity	11.8 Wh (1 650 mAh)
Maximum dimensions	Approx. 38.2 × 20.5 × 55.6 mm (1 9/16 × 13/16 × 2 1/4 inches) (W/H/D)
Mass	Approx. 78 g (2.8 oz)

Design and specifications are subject to change without notice.

Reset default

●: reset

○: not reset

* → Pages on the “Read This First”

A: AUTO shooting (page 34)

B: Scene Selection (page 35)

C: Reset of recording function (page 104)

D: Reset default (page 126)

Using the dial or button

Items	Reset to	A	B	C	D	Page
Super SteadyShot	—	○	○	○	○	14*
Adjusting the diopter	—	○	○	○	○	17*
Recording display	Detailed display	○	○	○	●	23
Exposure mode	—	—	—	○	○	34
Exposure compensation	±0	●	●	●	●	45
Metering mode	Multi segment	●	●	○	○	48
Focus mode (AF-S/AF-A/AF-C/MF)	AF-A	●	● ¹⁾	○	○	52
Drive mode	Single-image advance	●	● ²⁾	●	●	55
White balance	AWB (Auto white balance)	●	●	●	●	61
Color temperature/color filter	5500K, Color filter 0	—	—	●	●	62
Custom white balance	5500K	○	○	●	●	63
ISO	AUTO	●	●	●	●	64
C (Custom) button	Creative Style	○	○	●	●	81
Playback display	Single-image screen (with recording data)	○	○	○	●	83

1) “AF-C” when in Sports action mode, “AF-S” when in Macro mode.

2) “Continuous Hi” when in Sports action mode.

Recording menu



Items	Reset to	A	B	C	D	Page
Image size	L:12M	○	○	●	●	94
Aspect ratio	3:2	○	○	●	●	95
Quality	Fine	○	○	●	●	96
D-RangeOptimizer	Standard	● ³⁾	● ³⁾	●	●	66
Creative Style	Standard	●	—	●	●	67
Custom button	Creative Style	○	○	●	●	81
Exposure step	0.3 EV	○	○	●	●	98
Flash mode	Autoflash	●	●	● ⁴⁾	● ⁵⁾	73
Flash control	ADI flash	●	●	●	●	99
Power ratio	1/1	○	○	●	●	100
Flash compens.	±0.0	●	●	●	●	75
ISO Auto max.	800	—	—	●	●	100
ISO Auto min.	200	—	—	●	●	100
AF-A setup	AF-A	●	●	●	●	101
AF area	Wide	●	●	●	●	49
Priority setup	AF	●	●	●	●	102
AF illuminator	Auto	●	●	●	●	54
AF w/ shutter	On	●	●	●	●	102
Long exp.NR	On	●	●	●	●	103
High ISO NR	Normal	●	●	●	●	103

³⁾ Resets to “Advanced Auto” when in AUTO. For Scene Selection, reset is different, depending on the mode.

⁴⁾ “Fill-flash”

⁵⁾ “Autoflash” or “Fill-flash” (“Rear sync.” or “Wireless” is canceled.)

Custom menu

Items	Reset to	A	B	C	D	Page
Eye-Start AF	On	○	○	○	●	105
EyeStart trigr.	w/ GripSensor	○	○	○	●	105
AF/MF button	AF/MF control	○	○	○	●	105
AF/MF control	Hold	○	○	○	●	106
AF drive speed	Fast	○	○	○	●	106
AF area disp.	0.3 sec	○	○	○	●	106
FocusHoldButton	Focus hold	○	○	○	●	106
AEL button	AEL hold	○	○	○	●	107
Ctrl dial setup	 SS  F/no.	○	○	○	●	107
Dial exp.comp	Off	○	○	○	●	108
Ctrl dial lock	Off	○	○	○	●	109
Button ops.	Exclusive disp	○	○	○	●	109
Release w/oCard	Enable	○	○	○	●	109
Release w/oLens	Disable	○	○	○	●	109
Red eye reduc.	Off	○	○	○	●	110
Exp.comp.set	Ambient&flash	○	○	○	●	110
Bracket order	0 → - → +	○	○	○	●	111
Auto review	2 sec	○	○	○	●	111
Auto off w/ VF	On	○	○	○	●	111
Rec.info.disp.	Auto rotate	○	○	○	●	112
Img.orientation	Record	○	○	○	●	112

Playback menu

Items	Reset to	A	B	C	D	Page
Date imprint	Off	○	○	○	●	117
Index print	—	○	○	○	○	117
PlaybackDisplay	Auto rotate	○	○	○	●	118
Slide show	3 sec	○	○	○	●	119

Setup menu

Items	Reset to	A	B	C	D	Page
LCD brightness	±0	○	○	○	●	120
Info.disp.time	5 sec	○	○	○	●	120
Power save	3 min	○	○	○	●	120
Video output	—	○	○	○	○	121
HDMI output	HD(1080i)prior.	○	○	○	●	121
Date/Time setup	—	○	○	○	○	122
Memory card	CompactFlash	○	○	○	○	123
File number	Series	○	○	○	●	123
Folder name	Standard form	○	○	○	●	123
Select folder	—	○	○	○	○	124
USB connection	Mass Storage	○	○	○	●	124
MassStrg.card	Selected card	○	○	○	●	124
Menu start	Top	○	○	○	●	125
Delete confirm.	“Cancel” first	○	○	○	●	125
Audio signals	On	○	○	○	●	125

Index

Numerics

40-segment honeycomb pattern
metering.....48

A

AC Adaptor/charger 165

Access lamp

→ *step 3 in "Read This
First"*

Accessory shoe cap 167

ADI flash99

Adjusting exposure.....45

Adjusting the diopter

→ *step 5 in "Read This
First"*

Adobe RGB72

AE lock46

AEL button107

AF area49, 101

AF area disp.....106

AF drive speed.....106

AF illuminator102

AF lock105

AF w/ shutter102

AF/MF button.....53, 105

AF/MF control.....106

AF-A setup101

Ambient bracket58

Aperture priority37

Aspect ratio.....95

Attaching a lens

→ *step 2 in "Read This
First"*

Audio signals.....125

Auto adjustment mode

→ *step 5 in "Read This
First"*

Auto off w/ VF111

Auto review111

Autoflash73

Automatic AF52

B

Battery charger..... 164

→ *step 1 in "Read This
First"*

Battery pack 163

→ *step 1 in "Read This
First"*

Bracket 57

Bracket order..... 111

Brightness 68

BULB shooting 43

Button ops 109

C

Camera-shake warning

→ *step 5 in "Read This
First"*

CD-ROM 136

Center weighted 48

Charging battery pack

→ *step 1 in "Read This
First"*

Cleaning 168

Cleaning mode 125

Cloudy (WB).....62

Color 61

Color filter.....62

Color temperature 62

Compression ratio 96

Computer127

Copying images 130

Recommended
environment..... 128, 135

Software135

Viewing image files stored
on a computer with your
camera..... 134

Connecting

Computer129

Printer146

TV89

Continuous AF 52

Continuous bracket.....57

Continuous shooting.....56

Contrast67

Copying images to your
computer130

Creative Style67, 97

Ctrl dial lock.....109

Ctrl dial setup107

Custom button81, 98

Custom menu 1.....105

Custom menu 2.....107

Custom menu 3.....110

Custom menu 4.....113

Custom reset113

Custom white balance63

D

Date imprint.....117

Date/Time setup122

→ *step 4 in "Read This
First"*

Daylight (WB).....62

DC IN terminal165

Delete114

→ *step 6 in "Read This
First"*

Delete confirm.....125

Depth-of-field preview39

Dial exp.comp108

Direct Manual Focus101

Distance to the subject.....50

DPOF setup116

D-Range Optimizer66, 97

Drive mode55

E

Effective pixels.....170

Enlarge86

EV scale.....42, 47, 58

Exp.comp.set110

Exposure Bracket57

Exposure step.....	98
Extension	134
External flash.....	74, 166
Eyecup.....	44
Eyepiece cover.....	44
Eye-Start AF.....	105
EyeStart trigr.....	105

F

File name	133
File number.....	123
File storage destination.....	133
Fill-flash.....	73
Flash (WB)	62
Flash bracket.....	58
Flash compensation	75
Flash control	99
Flash mode.....	73, 99
→ <i>step 5 in “Read This First”</i>	

Flash range.....	65
Flash sync terminal.....	77
Fluorescent (WB).....	62
F-number	37
Focus.....	49
Focus mode.....	52
FocusHoldButton.....	106
Focus-lock	51
Folder name	123
Format.....	115

H

HDMI output	90, 121
High ISO NR	103
High Speed Sync shooting	167
Histogram display.....	85
Holding the camera	
→ <i>step 5 in “Read This First”</i>	

I

Identifying parts	14
Image Data Converter SR ..	139
Image Data Lightbox SR....	140
Image file storage destinations and file names	133
Image quality.....	96
Image size	94
Img.orientation	112
Index print.....	117
Index screen	84
Indicator	19
Info.disp.time	120
Install.....	136
Internal rechargeable battery	169
ISO	64
ISO Auto max.	100
ISO Auto min.	100

J

JPEG.....	96
-----------	----

L

Landscape (Scene Selection)	35
Language.....	121
→ <i>step 4 in “Read This First”</i>	
LCD monitor	20
LCDbrightness	120
Local AF area.....	50
Locking exposure.....	46
Long exp.NR.....	103
Long exposure shooting.....	43
Luminance limit warning.....	85

M

Macro	35
Manual exposure.....	41
Manual flash.....	99

Manual focus	53
Manual shift.....	43
Mass Storage	124
Memory	79, 104
Memory card	123, 161

Insert/Remove
→ *step 3 in “Read This First”*

Number of images	24
“Memory Stick Duo”.....	161
Menu.....	32
Custom menu 1	105
Custom menu 2	107
Custom menu 3	110
Custom menu 4	113
Playback menu 1	114
Playback menu 2	119
Recording menu 1	94
Recording menu 2	99
Recording menu 3	101
Recording menu 4	104
Setup menu 1	120
Setup menu 2	123
Setup menu 3	125

Menu start.....	125
Metering mode.....	48
Moisture condensation.....	168
Multi segment.....	48

N

New folder	124
Night portrait	36
Night view (Scene Selection)	36
Number of images	24

O

OS.....	128, 135
---------	----------

P

PictBridge.....	146
-----------------	-----

Picture Motion Browser	137
Pixel.....	94
Playback menu 1	114
Playback menu 2	119
PlaybackDisplay	118
Portrait (Scene Selection).....	35
Power cord	
→ <i>step 1 in “Read This First”</i>	
Power ratio	100
Power save.....	120
→ <i>step 4 in “Read This First”</i>	
Precautions	168
Pre-flash TTL	99
Pressing halfway down	
→ <i>step 5 in “Read This First”</i>	
Print	145
Printing directly	146
Priority setup	102
Program auto shooting.....	34
Program Shift	36
Protect.....	115

R

RAW.....	96
Rear sync.	74
Rec mode reset	104
Rec.info.disp.....	112
Recording information display	20, 23, 112
Recording menu 1	94
Recording menu 2	99
Recording menu 3	101
Recording menu 4	104
Red eye reduc.	110
Release w/oCard.....	109
Release w/oLens.....	109
Remote Camera Control.....	142
Remote Commander	16, 60, 166

Reset default	126
Rotate	88

S

Saturation	67
Scene Selection	35

Screen

Changing the display	23
Indicator.....	19
Select folder	124
Self-timer	57
Set the clock	
→ <i>step 4 in “Read This First”</i>	

Setup menu 1	120
Setup menu 2	123
Setup menu 3	125
Shade (WB).....	62
Sharpness	67
Shoulder strap	17
Shutter speed priority.....	39
Single bracket	58
Single-shot AF	52
Slide show.....	119
Slow Sync	77
Software	136
Specifications.....	170
Sports action	35
Spot	48
Spot AF area	50
Sunset (Scene Selection).....	35
Super SteadyShot scale	
→ <i>step 5 in “Read This First”</i>	

T

Troubleshooting.....	149
Tungsten (WB)	62
TV	89

U

USB cable.....	129, 146
USB connection.....	124
Using your camera abroad	
→ <i>step 1 in “Read This First”</i>	

V

Vertical Grip.....	165
Video output.....	121
Viewing image	83
→ <i>step 6 in “Read This First”</i>	



W

Warning messages.....	158
White balance	61
White balance bracket	59
Wide AF area	49
Windows computer	
Recommended environment	128
Wireless flash	74

Z

Zone Matching	68, 71
Zoom	
→ <i>step 5 in “Read This First”</i>	

Trademarks

- **α** is a trademark of Sony Corporation.
- “Memory Stick”, , “Memory Stick PRO”, **MEMORY STICK PRO**, “Memory Stick Duo”, **MEMORY STICK DUO**, “Memory Stick PRO Duo”, **MEMORY STICK PRO DUO**, “Memory Stick PRO-HG Duo”, “**MEMORY STICK PRO-HG DUO**”, “Memory Stick Micro”, “MagicGate”, and **MAGICGATE** are trademarks of Sony Corporation.
- “InfoLITHIUM” is a trademark of Sony Corporation.
- “PhotoTV HD” is a trademark of Sony Corporation.
- Microsoft, Windows, and Windows Vista are either registered trademarks or trademarks of Microsoft Corporation in the United States and/ or other countries.
- Macintosh, Mac OS, iMac, iBook, PowerBook, Power Mac, and eMac are trademarks or registered trademarks of Apple Inc.
- HDMI, the HDMI logo and High-Definition Multimedia Interface are trademarks or registered trademarks of HDMI Licensing LLC.
- Intel, Intel Core, MMX, and Pentium are trademarks or registered trademarks of Intel Corporation.
- CompactFlash is a trademark of SanDisk Corporation.
- Microdrive is a registered trademark of Hitachi Global Storage Technologies in the United States and/or other countries.
- Adobe is a registered trademark or a trademark of Adobe Systems Incorporated in the United States and/or other countries.
- D-Range Optimizer Advanced uses technology provided by  Apical Limited.
- In addition, system and product names used in this manual are, in general, trademarks or registered trademarks of their respective developers or manufacturers. However, the TM or ® marks are not used in all cases in this manual.