

Before your operation

Using the shooting functions

Using the viewing functions

Using the menu

Using your computer

Printing images

Troubleshooting

Others

Index

Digital Single Lens Reflex Camera **User's Guide/ Troubleshooting**



α 100

DSLR-A100



"Read This First" (separate volume)
Explains the set-up and basic operations for shooting/
playback with your camera.

Additional information on this product and answers to frequently asked questions can be found at our Customer Support Website.

<http://www.sony.net/>



Printed on 100% recycled paper using VOC
(Volatile Organic Compound)-free vegetableoil based ink.

Printed in Malaysia



2681187120

Operating Instructions

Before operating the unit, please read this manual and "Read This First" (separate volume) thoroughly, and retain it for future reference.

Owner's Record

The model and serial numbers are located on the bottom.
Record the serial number in the space provided below.
Refer to these numbers whenever you call upon your Sony dealer regarding this product.
Model No. DSLR-A100
Serial No. _____

© 2006 Sony Corporation



WARNING

To reduce fire or shock hazard, do not expose the unit to rain or moisture.

For Customers in the U.S.A.

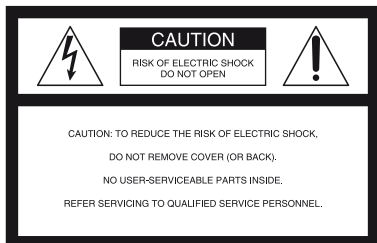

This symbol is intended to alert the user to the presence of uninsulated “dangerous voltage” within the product’s enclosure that may be of sufficient magnitude to constitute a risk of electric shock to persons.



This symbol is intended to alert the user to the presence of important operating and maintenance (servicing) instructions in the literature accompanying the appliance.

IMPORTANT SAFEGUARDS

For your protection, please read these safety instructions completely before operating the appliance, and keep this manual for future reference.

Carefully observe all warnings, precautions and instructions on the appliance, or the one described in the operating instructions and adhere to them.

Use

Power Sources

This set should be operated only from the type of power source indicated on the marking label. If you are not sure of the type of electrical power supplied to your home, consult your dealer or local power company. For those sets designed to operate from battery power, or other sources, refer to the operating instructions.

Polarization

This set may be equipped with a polarized ac power cord plug (a plug having one blade wider than the other).

This plug will fit into the power outlet only one way. This is a safety feature. If you are unable to insert the plug fully into the outlet, try reversing the plug. If the plug should still fail to fit, contact your electrician to have a suitable outlet installed. Do not defeat the safety purpose of the polarized plug by forcing it in.

Overloading

Do not overload wall outlets, extension cords or convenience receptacles beyond their capacity, since this can result in fire or electric shock.

Object and Liquid Entry

Never push objects of any kind into the set through openings as they may touch dangerous voltage points or short out parts that could result in a fire or electric shock. Never spill liquid of any kind on the set.

Attachments

Do not use attachments not recommended by the manufacturer, as they may cause hazards.

Cleaning

Unplug the set from the wall outlet before cleaning or polishing it. Do not use liquid cleaners or aerosol cleaners. Use a cloth lightly dampened with water for cleaning the exterior of the set.

Installation

Water and Moisture

Do not use power-line operated sets near water – for example, near a bathtub, washbowl, kitchen sink, or laundry tub, in a wet basement, or near a swimming pool, etc.

Power-Cord Protection

Route the power cord so that it is not likely to be walked on or pinched by items placed upon or against them, paying particular attention to the plugs, receptacles, and the point where the cord exits from the appliance.

Accessories

Do not place the set on an unstable cart, stand, tripod, bracket, or table. The set may fall, causing serious injury to a child or an adult, and serious damage to the set. Use only a cart, stand, tripod, bracket, or table recommended by the manufacturer.

Ventilation

The slots and openings in the cabinet are provided for necessary ventilation. To ensure reliable operation of the set, and to protect it from overheating, these slots and openings must never be blocked or covered.

- Never cover the slots and openings with a cloth or other materials.
- Never block the slots and openings by placing the set on a bed, sofa, rug, or other similar surface.
- Never place the set in a confined space, such as a bookcase, or built-in cabinet, unless proper ventilation is provided.
- Do not place the set near or over a radiator or heat register, or where it is exposed to direct sunlight.

Lightning

For added protection for this set during a lightning storm, or when it is left unattended and unused for long periods of time, unplug it from the wall outlet and disconnect the antenna or cable system. This will prevent damage to the set due to lightning and power-line surges.

Service

Damage Requiring Service

Unplug the set from the wall outlet and refer servicing to qualified service personnel under the following conditions:

- When the power cord or plug is damaged or frayed.
- If liquid has been spilled or objects have fallen into the set.
- If the set has been exposed to rain or water.
- If the set has been subject to excessive shock by being dropped, or the cabinet has been damaged.
- If the set does not operate normally when following the operating instructions. Adjust only those controls that are specified in the operating instructions. Improper adjustment of other controls may result in damage and will often require extensive work by a qualified technician to restore the set to normal operation.
- When the set exhibits a distinct change in performance – this indicates a need for service.

Servicing

Do not attempt to service the set yourself as opening or removing covers may expose you to dangerous voltage or other hazards.

Refer all servicing to qualified service personnel.

Replacement parts

When replacement parts are required, be sure the service technician has used replacement parts specified by the manufacturer that have the same characteristics as the original parts.

Unauthorized substitutions may result in fire, electric shock, or other hazards.

Safety Check

Upon completion of any service or repairs to the set, ask the service technician to perform routine safety checks (as specified by the manufacturer) to determine that the set is in safe operating condition.

Read this first

CAUTION

Replace the battery with the specified type only. Otherwise, fire or injury may result.

For Customers in the U.S.A. and Canada

RECYCLING LITHIUM-ION BATTERIES

Lithium-Ion batteries are recyclable.

You can help preserve our environment by returning your used rechargeable batteries to the collection and recycling location nearest you.



For more information regarding recycling of rechargeable batteries, call toll free 1-800-822-8837, or visit <http://www.rbrbc.org/>

Caution: Do not handle damaged or leaking Lithium-Ion batteries.

For Customers in the U.S.A.

If you have any questions about this product, you may call:

Sony Customer Information Services Center
1-800-222-SONY (7669)

The number below is for the FCC related matters only.

Regulatory Information

Declaration of Conformity

Trade Name: SONY

Model No.: DSLR-A100

Responsible Party: Sony Electronics Inc.

Address: 16530 Via Esprillo,
San Diego, CA 92127 U.S.A.

Telephone No.: 858-942-2230

This device complies with Part 15 of the FCC Rules. Operation is subject to the following two conditions: (1) This device may not cause harmful interference, and (2) this device must accept any interference received, including interference that may cause undesired operation.

CAUTION

You are cautioned that any changes or modifications not expressly approved in this manual could void your authority to operate this equipment.

Note:

This equipment has been tested and found to comply with the limits for a Class B digital device, pursuant to Part 15 of the FCC Rules.

These limits are designed to provide reasonable protection against harmful interference in a residential installation. This equipment generates, uses, and can radiate radio frequency energy and, if not installed and used in accordance with the instructions, may cause harmful interference to radio communications. However, there is no guarantee that interference will not occur in a particular installation. If this equipment does cause harmful interference to radio or television reception, which can be determined by turning the equipment off and on, the user is encouraged to try to correct the interference by one or more of the following measures:

- Reorient or relocate the receiving antenna.
- Increase the separation between the equipment and receiver.
- Connect the equipment into an outlet on a circuit different from that to which the receiver is connected.
- Consult the dealer or an experienced radio/TV technician for help.

The supplied interface cable must be used with the equipment in order to comply with the limits for a digital device pursuant to Subpart B of Part 15 of FCC Rules.

Memory Stick Duo Adaptor for CF slot

For the Customers in the U.S.A. and Canada

THIS DEVICE COMPLIES WITH PART 15 OF THE FCC RULES. OPERATION IS SUBJECT TO THE FOLLOWING TWO CONDITIONS:

(1) THIS DEVICE MAY NOT CAUSE HARMFUL INTERFERENCE, AND (2) THIS DEVICE MUST ACCEPT ANY INTERFERENCE RECEIVED, INCLUDING INTERFERENCE THAT MAY CAUSE UNDESIRE OPERATION.

THIS CLASS B DIGITAL APPARATUS COMPLIES WITH CANADIAN ICES-003.

For Customers in Europe

This product has been tested and found compliant with the limits set out in the EMC Directive for using connection cables shorter than 3 meters (9.8 feet).

Attention

The electromagnetic fields at the specific frequencies may influence the picture and sound of this unit.

Notice

If static electricity or electromagnetism causes data transfer to discontinue midway (fail), restart the application or disconnect and connect the communication cable (USB, etc.) again.

Disposal of Old Electrical & Electronic Equipment (Applicable in the European Union and other European countries with separate collection systems)



This symbol on the product or on its packaging indicates that this product shall not be treated as household waste. Instead it shall be handed over to the applicable collection point for the recycling of electrical and electronic equipment. By ensuring this product is disposed of correctly, you will help prevent potential negative consequences for the environment and human health, which could otherwise be caused by inappropriate waste handling of this product. The recycling of materials will help to conserve natural resources. For more detailed information about recycling of this product, please contact your local Civic Office, your household waste disposal service or the shop where you purchased the product.

Notice for customers in the United Kingdom

A moulded plug complying with BS 1363 is fitted to this equipment for your safety and convenience. Should the fuse in the plug supplied need to be replaced, a fuse of the same rating as the supplied one and approved by ASTA or BSI to BS 1362, (i.e., marked with an ⚡ or ⚡ mark) must be used.

If the plug supplied with this equipment has a detachable fuse cover, be sure to attach the fuse cover after you change the fuse. Never use the plug without the fuse cover. If you should lose the fuse cover, please contact your nearest Sony service station.

Notes on using your camera

Types of “Memory Stick” that can be used (not supplied)

There are two types of “Memory Stick”.

“Memory Stick”: you cannot use a “Memory Stick” with your camera.



“Memory Stick Duo”: Inserting a “Memory Stick Duo” into a Memory Stick Duo Adaptor for CF slot (supplied).

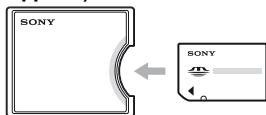

- When using a “Memory Stick Duo” with the write-protect switch, set the switch to the recording position.
- For details on “Memory Stick”, see page 139.

Notes on the battery pack

- Charge the NP-FM55H (supplied) battery pack before using the camera for the first time. (→ step 1 in “Read This First”)
- The battery pack can be charged even if it is not completely discharged. Also, even if the battery pack is not fully charged, you can use the partially charged capacity of the battery pack as is.
- If you do not intend to use the battery pack for a long time, use up the existing charge and remove it from your camera, then store it in a cool, dry place. This is to maintain the battery pack functions (page 142).
- For details on the battery pack, see page 142.

No compensation for contents of the recording

The contents of the recording cannot be compensated for if recording or playback is not possible due to a malfunction of your camera or recording media, etc.

Back up recommendation

To avoid the potential risk of data loss, always copy (back up) data to other medium.

Notes on recording/playback

- This camera is neither dust-proof, nor splash-proof, nor water-proof. Read “Precautions” (page 147) before operating the camera.
- Before you record one-time events, make a trial recording to make sure that the camera is working correctly.
- Be careful not to get the camera wet. Water entering the inside of the camera may cause malfunctions which in some cases may not be repairable.
- Do not look at the sun or a strong light through a removed lens or the viewfinder. This may cause irrecoverable damage to your eyes. Or it may cause a malfunction of your camera.
- Do not use the camera near a location that generates strong radio waves or emits radiation. The camera may not be able to record or play back properly.
- Using the camera in sandy or dusty locations may cause malfunctions.
- If moisture condensation occurs, remove it before using the camera (page 147).
- Do not shake or strike the camera. In addition to malfunctions and an inability to record images, this may render the recording medium unusable, or cause image data breakdown, damage or loss.
- Clean the flash surface before use. The heat of flash emission may cause dirt on the flash surface to become discolored or to stick to the flash surface, resulting in insufficient light emission.
- Keep the camera, supplied accessories, etc., out of the reach of children. The battery pack, the shoe cap, etc., may be swallowed. If such a problem occurs, consult a doctor immediately.

Notes on the LCD monitor and lens

- The LCD monitor is manufactured using extremely high-precision technology so over 99.99% of the pixels are operational for effective use. However, there may be some tiny black points and/or bright points (white, red, blue or green in color) that constantly appear on the LCD monitor. These points are normal in the manufacturing process and do not affect the images in any way.



Black, white, red, blue and green points

- Do not expose the camera to direct sunlight. If sunlight is focused on a nearby object, it may cause a fire. When you must place the camera under direct sunlight, attach the lens cap.
- Images may trail across on the LCD monitor in a cold location. This is not a malfunction. When turning on the camera in a cold location, the LCD monitor may become temporarily dark. When the camera warms up, the monitor will function normally.
- Do not press against the LCD monitor. The monitor may be discolored and that may cause a malfunction.

On focal length

The picture angle of this camera is narrower than that of a 35 mm-format film camera. You can find the approximate equivalent of the focal length of a 35 mm-format film camera, and shoot with the same picture angle, by increasing the focal length of your lens by half.

For example, by using a 50 mm lens, you can get the approximate equivalent of a 75 mm lens of a 35 mm-format film camera.

On image data compatibility

- This camera conforms with DCF (Design rule for Camera File system) universal standard established by JEITA (Japan Electronics and Information Technology Industries Association).
- Playback of images recorded with your camera on other equipment and playback of images recorded or edited with other equipment on your camera are not guaranteed.

Warning on copyright

Television programs, films, videotapes, and other materials may be copyrighted. Unauthorized recording of such materials may be contrary to the provisions of the copyright laws.

The pictures used in this manual

The photographs used as examples of pictures in this manual are reproduced images, and are not actual images shot using this camera.





Table of contents



Notes on using your camera	7
Basic techniques for better images	13
Focus – Focusing on a subject successfully.....	13
Exposure – Adjusting the light intensity	16
Color – On the effects of lighting.....	17
Quality – On “image quality” and “image size”	17

Before your operation

Identifying parts.....	19
Indicators on the monitor.....	22
Switching the recording information display	26
Number of images.....	27
The number of images that can be recorded when using the battery pack	29
Operation workflow.....	30

Using the shooting functions







Using the mode dial.....	31
Scene Selection.....	32
Shooting with Program auto	33
Shooting with aperture priority mode	34
Shooting with shutter speed priority mode.....	36
Shooting with manual exposure mode	37
Using the function dial.....	42
How to use the function dial	43
Setting ISO/Zone Matching	44
Adjusting the white balance	46
D-Range Optimizer.....	49
Selecting the color/DEC mode.....	49
Focus mode.....	51
Flash.....	54
Metering mode	58
Using the  /  (Drive) button	60
How to use the  /  (Drive) button	60
Shooting continuously	61
Using the self-timer	62
Shooting three images with the exposure shifted – Exposure Bracket.....	62
White balance bracket shooting.....	64

 Adjusting the exposure	65
 Locking the exposure (AE lock)	67
 Slow Sync (Shooting the dark background with flash).....	69
Depth-of-field preview	70
Focusing manually	71

Using the viewing functions

Switching the playback screen.....	72
Displaying the histogram.....	74
Rotating an image.....	76
Enlarging images	77
Viewing images on a TV screen	78

Using the menu

Using menu items	80
Menu list.....	82
 Recording menu 1	83
Image size	
Quality	
Inst.Playback	
Noise reductn	
Eye-Start AF	
 Recording menu 2	86
Red eye	
Flash control	
Flash default	
Bracket order	
 Reset	
 Playback menu 1	88
Delete	
Format	
 Protect	
Index format	
 Playback menu 2	91
Slide show	
 DPOF set	

⚙️ Custom menu 1	93
Priority setup	
FocusHoldButt.	
AEL button	
Ctrl dial set	
Exp. comp. set	
AF illuminator	
⚙️ Custom menu 2	96
Shutter lock	
Shutter lock	
AF area setup	
Monitor Disp.	
Rec. display	
Play. display	
🔑 Setup menu 1	98
LCDbrightness	
Transfer mode	
Video output	
Audio signals	
🗣️ Language	
Date/Time set	
🔑 Setup menu 2	100
File # memory	
Folder name	
Select folder	
🔑 Setup menu 3	102
LCD backlight	
Power save	
MenuSec.Memory	
Delete conf.	
Clean CCD	
Reset default	

Using your computer

Enjoying your Windows computer	105
Copying images to your computer	107
Viewing image files stored on a computer with your camera	113
Installing the software (supplied)	114
Using the software (supplied)	115
Using your Macintosh computer	120

Printing images

How to print images	122
Printing images directly using a PictBridge compliant printer	123

Troubleshooting

Troubleshooting.....	127
Warning messages	137

Others

On the "Memory Stick"	139
On the CF card/Microdrive.....	141
On the battery pack	142
On the battery charger	143
Optional accessories	144
Precautions	147
Specifications.....	149
Reset default.....	151

Index

155

Basic techniques for better images

Focus

Exposure

Color

Quality

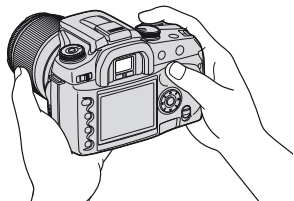

This section describes the basics so you can enjoy your camera. It tells you how to use various camera functions such as the mode dial (page 31), the function dial (page 42), the menus (page 80), and so on.

Focus *Focusing on a subject successfully*

When you look into the viewfinder, or you press the shutter button halfway down, the camera adjusts the focus automatically (Auto Focus). Make it a habit to press the shutter button only halfway down to confirm that the subject is visually in focus.

Press the shutter button fully down straight away.



Press the shutter button halfway down.

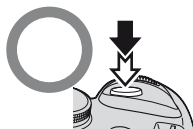

AE/AF lock



Then press the shutter button fully down.



If the image looks blurred even after focusing, it may be because of camera shake. → See “Hints for preventing blur” (as follows).

Hints for preventing blur

Hold the camera steady, keeping your arms at your side and support the lens with the palm of your left hand. Step out with one foot to stabilize your upper body, leaning against a wall or putting your elbow on a table will also provide support. Using a tripod, or using the Super SteadyShot function is also recommended.



In a dark location, using the flash allows you to take a bright picture even of a subject in dim light and it also helps to prevent camera shake.

If you want to make the most of the ambient light, or if the subject is out of flash range, you can increase the shutter speed to reduce the camera shake without firing the flash by increasing the ISO. (However, this tends to make the image grainy or subject to noise.)

When the subject is outside the focus frame (Focus-lock)



Normally, in auto focus mode, place the subject within the focus frame  and take the picture. If the subject is off-center and outside the focus frame, the background within the focus frame will be in focus and the subject will be out of focus. To prevent this, use the focus-lock function by following the steps below.

- The focus-lock function is also effective when shooting subjects with which autofocus is less effective (page 15).

① Place the subject within the focus frame and press the shutter button halfway down.



- The ● indicator lights up in the viewfinder. A local focus frame is illuminated briefly to indicate the point of focus.

- ② Keep the shutter button halfway down, and put the subject back in the original position to re-compose the shot.

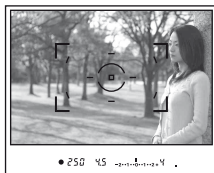

- ③ Press the shutter button fully down to take the picture.

- The focus-lock function will lock the exposure as well (when multi segment metering is selected (page 58)).
- Releasing the shutter button after shooting will disengage the focus-lock. If you keep the shutter button halfway down after shooting, you can continue shooting with the same focal point.
- If the ● indicator does not light up in the viewfinder (the subject is in motion), you cannot use the focus-lock function by pressing the shutter button halfway down. (See pages 53 and 71.)

Subjects that may require special focusing:

Using the auto focus, it is hard to focus on the following subjects. In such cases, use the focus lock shooting feature or manual focus (page 71).

- A subject that is low in contrast, such as blue sky or a white wall.
- Two subjects at different distances overlapping in the focus frame.
- A subject that is composed of repeating patterns, such as the facade of a building.
- A subject that is very bright or glittering, such as the sun, the body of an automobile, or the surface of water.

To measure the exact distance to the subject

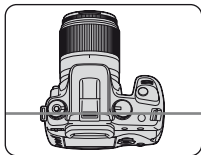

The horizontal line in the illustration shows the location of the CCD* plane. When you measure the exact distance between the camera and the subject, refer to the position of the horizontal line.

* The CCD is the part of the camera that acts as the film.

Exposure Adjusting the light intensity

You can create various images by adjusting the shutter speed and aperture. Exposure is the amount of light that the camera will receive when you release the shutter.

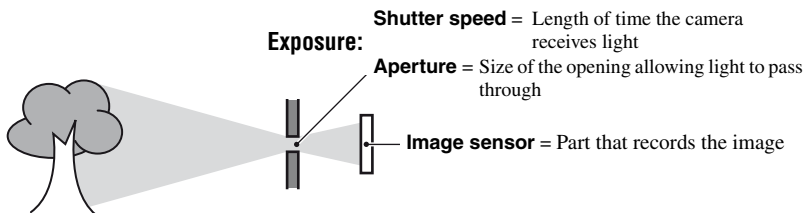

Overexposure
= too much light
Whitish image



Correct exposure



Underexposure
= too little light
Darker image

The exposure is automatically set to the proper value in the auto adjustment mode. However, you can adjust it manually using the functions below.

Manual exposure:

Allows you to adjust the shutter speed and aperture value manually. → page 37

Metering Mode:

Allows you to change the part of the subject to be measured to determine the exposure. → page 58

Exposure compensation:





Allows you to adjust the exposure that has been determined by the camera.
→ page 65

Color

On the effects of lighting

The apparent color of the subject is affected by the lighting conditions.

Example: The color of an image affected by light sources

Weather/lighting	Daylight	Cloudy	Fluorescent	Incandescent
				
Characteristics of light	White (standard)	Bluish	Blue-tinged	Reddish

The color tones are adjusted automatically in the auto white balance mode. However, you can adjust color tones manually with the white balance mode (page 46).

Quality

On “image quality” and “image size”

A digital image is made up of a collection of small dots called pixels. If it contains a large number of pixels, the picture becomes large, it takes up more memory, and the image is displayed in fine detail. “Image size” is shown by the number of pixels. Although you cannot see the differences on the screen of the camera, the fine detail and data processing time differ when the image is printed or displayed on a computer screen.

Description of the pixels and the image size

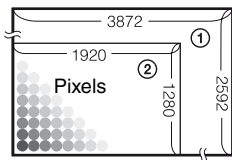

- ① Image size: L:10M
 $3,872 \text{ pixels} \times 2,592 \text{ pixels} = 10,036,224 \text{ pixels}$
- ② Image size: S:2.5M
 $1,920 \text{ pixels} \times 1,280 \text{ pixels} = 2,457,600 \text{ pixels}$

Selecting the image size for use

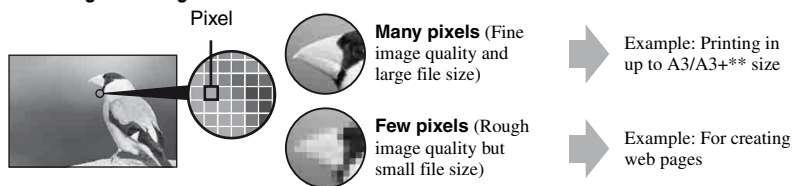

The default settings are marked with ✓.

	Image size*		Usage guidelines	No. of images	Printing
✓	L:10M	Larger	For storing important images or printing A3/A3+** size or fine A4 size images.	Less 	Fine
	M:5.6M	↕ Smaller	For printing in A4 size or high density images in A5 size	↕	↕
	S:2.5M		For recording a large number of images For creating web pages	More 	Rough

* The images recorded using the camera are the same 3:2 ratio as used photograph printing paper or postcards, etc.

** This is a size larger than A3 size. You can print images with a margin around the A3 size image.

Selecting the image quality (compression ratio) in combination (page 83)

You can select the compression ratio when digital images are saved. When you select a high compression ratio, the image lacks the fineness of detail, but has a smaller file size.

Identifying parts

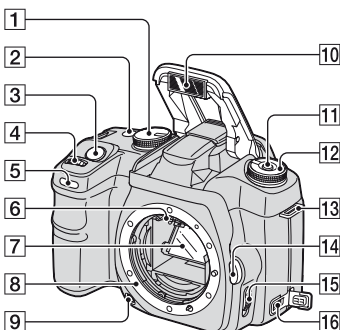

* Do not directly touch these parts.
See the pages in parentheses for details of operation.

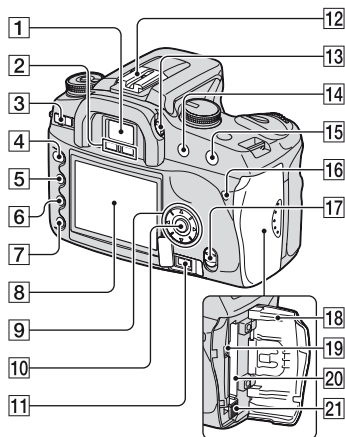

- 1** Mode dial (31)
- 2** (Drive) button (60)
- 3** Shutter button (→ step 5 in “Read This First”)
- 4** Control dial (33, 94)
- 5** Self-timer lamp (62)
- 6** Lens contacts*
- 7** Mirror*
- 8** Lens mount
- 9** Depth-of-field preview button (70)
- 10** Built-in flash* (→ step 5 in “Read This First”)
- 11** Fn (Function) button (43)
- 12** Function dial (42)
- 13** Hook for shoulder strap (21)
- 14** Lens release button (→ step 2 in “Read This First”)
- 15** Focus mode switch (71)
- 16** DC-IN terminal (144)



- 1** Viewfinder (→ step 5 in “Read This First”)
- 2** Eyepiece sensors (97)
- 3** POWER switch (→ step 3 in “Read This First”)
- 4** MENU button (80)
- 5** (Display) button (26, 72)
- 6** (Delete) button (→ step 6 in “Read This First”)
- 7** (Playback) button (→ step 6 in “Read This First”)
- 8** LCD monitor (22, 26)
- 9** Controller ((→ step 3 in “Read This First”)
For viewing: (Histogram) button (74)
 (Rotate) button (76)
- 10** Center button (→ step 3 in “Read This First”)/Spot-AF button (51)
- 11** REMOTE (Remote-control) jack (144)
- 12** Accessory shoe (145)
- 13** Diopter-adjustment dial (→ step 5 in “Read This First”)

- 14 For shooting: +/- (Exposure) button (37, 65)
For viewing:  (Reduce) button (72, 77)
- 15 For shooting: AEL (AE lock) button (39, 67)
For viewing:  (Enlarge) button (77)
- 16 Access lamp (→ *step 4 in “Read This First”*)
- 17  (Super SteadyShot) switch (→ *step 5 in “Read This First”*)
- 18 CF card cover (→ *step 4 in “Read This First”*)
- 19 VIDEO/USB jack (78, 108)
- 20 CF card insertion slot (→ *step 4 in “Read This First”*)
- 21 CF card eject lever (→ *step 4 in “Read This First”*)

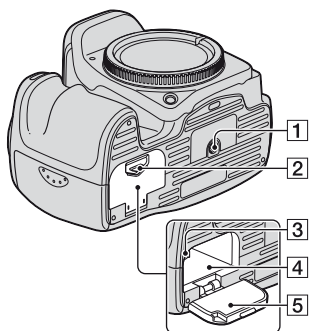

- 1 Tripod receptacle
 - Use a tripod with a screw length of less than 5.5 mm (7/32 inch). You will be unable to firmly secure the camera to tripods having screws longer than 5.5 mm (7/32 inch), and may damage the camera.
- 2 Battery cover open lever (→ *step 1 in “Read This First”*)
- 3 Lock lever (→ *step 1 in “Read This First”*)
- 4 Battery insertion slot (→ *step 1 in “Read This First”*)
- 5 Battery cover (→ *step 1 in “Read This First”*)

Attaching the shoulder strap

This camera has two hooks to attach the shoulder strap. Attach the end of the strap with the remote commander clip on the grip side of the camera. Attach the other end of the strap on the other side of the camera.

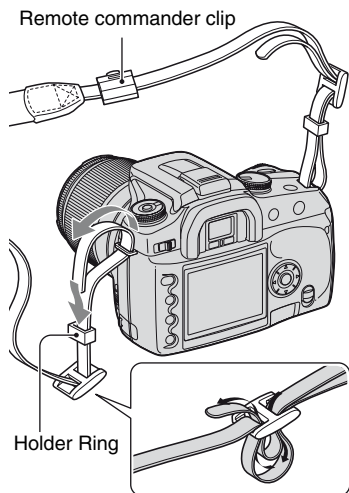

When threading the strap through the holder ring, hold the tip of the strap with your finger, as shown below, and slide the holder ring rather than the tip of the strap into position to secure the strap.

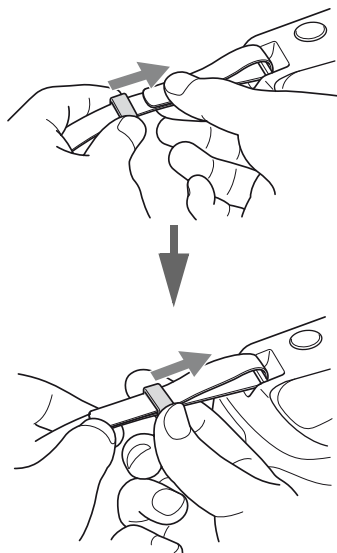

If the holder ring comes off the strap, put it back on the strap from the notched side.

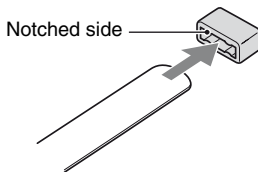

Indicators on the monitor

See the pages in parentheses for details of operation.

Viewfinder

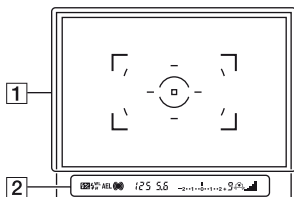

1

Display	Indication
[]	Wide focus frames (51)
[]	Local focus frames (51)
□	Spot AF frames (51)
○	Spot-metering area (51)

2

Display	Indication
[]	Flash-compensation (57)
⚡	Flashing: The flash is being charged Lit: The flash has been charged (→ step 5 in “Read This First”)
WL	Wireless flash (54)
H	High-speed sync (145)
AEL	AE lock (67)
● (⊙) (⊙)	Focus (→ step 5 in “Read This First”)
125	Shutter speed (36)
5.6	Aperture (34)
-2 · · 1 · · 0 · · 1 · · 2 +	Ev scale (38, 63, 68)
9	Frames-remaining counter (61)
[]	Camera-shake warning (→ step 5 in “Read This First”)
[]	Super SteadyShot scale (→ step 5 in “Read This First”)

LCD monitor (Recording information display)

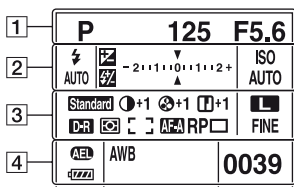

- The illustration above is for the full display in the horizontal position (page 26).

1

Display	Indication
AUTO P A S M	Mode dial (31)
[] [] []	
125	Shutter speed (36)
F5.6	Aperture (34)

2

Display	Indication
⚡ AUTO	Flash mode (54)
[] []	Exposure-compensation (65)/Metered Manual (38)
[]	Flash-compensation (57)
-2 · · 1 · · 0 · · 1 · · 2 +	Ev scale (38, 63, 68)
ISO AUTO ZONE	ISO sensitivity (44)/Zone Matching (45)

3

Display	Indication
Standard VIVID Port. Land Sun. Night B. Adobe	Color mode (49)
☾ +1	Contrast (50)
⊕ +1	Saturation (50)
▮ +1	Sharpness (50)
D-R D-RH	D-range optimizer (49)
☉ ☉ ☉	Metering (58)
[] [] []	AF area (51)
AFA AFS DMF AFC	AF mode (53)
RP	Release priority (93)
☐ ☐ ☐ 10 ☐ ☐ ☐ ☐	Drive mode (60)
L M S	Image size (83)
FINE STD RAW RAW+	Image quality (83)

4

Display	Indication
AE-L	AE lock (67)
⚡	Battery remaining (→ <i>step 1</i> in “Read This First”)
AWB ☀ +1 5500K M1	White balance (Auto, Preset, Color temperature, CC filter, Custom) (46)
0039	Remaining number of recordable images (27)

Operation guide

The next operation may be indicated on the lower portion of the LCD monitor.

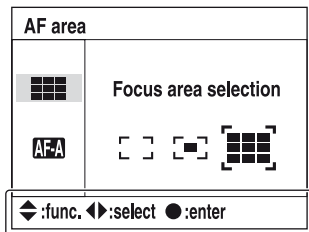

Display	Indication
◀▶	Controller ◀▶
⬆⬇	Controller ▲▼
◀▶	Controller ▲▼◀▶
●	Center of the controller
☀	Control dial
MENU ↻	Returns with MENU
▶ ↻	Returns with ▶ (77)
🔍	Switches folder frame and image frame in file browser (72)

LCD monitor (single-image playback)

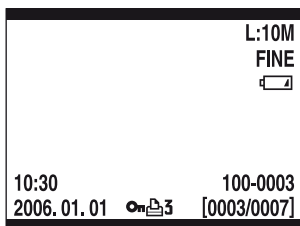

Display	Indication
L:10M M:5.6M S:2.5M	Image size (83)
FINE STD RAW RAW+	Image quality (83)
	Battery remaining (→ step 1 in "Read This First")
10:30 2006.01.01	Date of recording
	Protect (89)
	DPOF set (91)
100-0003	Folder - file number (112)
[0003/0007]	Frame number/total number of images

LCD monitor (Histogram display)

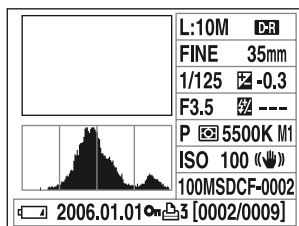

Display	Indication
	Playback image (74)
	Histogram (74)
L:10M M:5.6M S:2.5M	Image size (83)
	D-range optimizer (49)
FINE STD RAW RAW+	Image quality (83)
35mm	Focal length (8)
1/125	Shutter speed (36)
-0.3	Ev scale (65)
F3.5	Aperture (34)
	Flash-compensation (57)
AUTO P A S M 	Mode dial (31)
	Metering mode (58)
AWB +1 5500K M1	White balance (Auto, Preset, Color temperature, CC filter, Custom) (46)
ISO100	ISO sensitivity (ISO) (44)
	Super SteadyShot (→ step 5 in "Read This First")
100MSDCF-0002	Folder - file number (112)
	Battery remaining (→ step 1 in "Read This First")
2006.01.01	Date of recording
	Protect (89)

Display	Indication
 3	DPOF set (91)
[0002/0009]	File number/total number of images

Switching the recording information display

When recording, the LCD monitor on the back of the camera displays various recording information.

Press the  (Display) button to switch between the detailed display and the enlarged display that has less information in larger letters. You can choose to turn off the display to minimize battery consumption.

When you rotate the camera to a vertical position, the display automatically rotates to adjust to the camera position.

Horizontal position

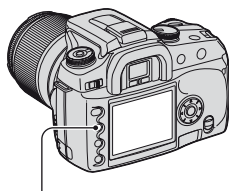

 (Display) button

Detailed display

AUTO	125	F5.6
-2+1+0+1+1+2+		
Standard	ISO	ISO AUTO
Standard	AWB	FINE
AE-L/AF-ON	ISO AUTO	0039

Enlarged display

AUTO	125	F5.6
ISO	+0.3	FINE
AUTO	AWB	FINE
Standard	AWB	FINE
AE-L/AF-ON	ISO AUTO	0039

No display

Vertical position

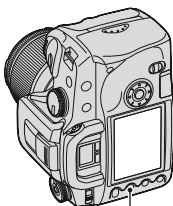

 (Display) button

Detailed display

AUTO	125	F5.6
-2+1+0+1+1+2+		
Standard	ISO	ISO AUTO
Standard	AWB	FINE
AE-L/AF-ON	ISO AUTO	0039

Enlarged display

125	F5.6	
AUTO	+0.3	
ISO	AWB	FINE
AUTO	AWB	FINE
Standard	AWB	FINE
AE-L/AF-ON	ISO AUTO	0039

No display

- The instructions in this operating instructions are based on the detailed display in the horizontal position. (The upper-left illustration.)
- You can choose to keep the display from rotating in the vertical position (page 97).
- For the screen displayed in playback mode, see page 72.

Number of images

The tables show the approximate number of images that can be recorded on a recording medium formatted with this camera. The values may vary depending on the shooting conditions.

The number of images

“Memory Stick Duo”

Image size: L:10M

(Units: Images)

Capacity Size	64MB	128MB	256MB	512MB	1GB	2GB
Standard	22	46	85	174	358	735
Fine	14	29	54	112	229	471
RAW & JPEG	2	5	10	23	48	100
RAW	3	7	14	30	62	128

Image size: M:5.6M

(Units: Images)

Capacity Size	64MB	128MB	256MB	512MB	1GB	2GB
Standard	39	80	145	296	606	1245
Fine	25	52	95	194	397	815

Image size: S:2.5M

(Units: Images)

Capacity Size	64MB	128MB	256MB	512MB	1GB	2GB
Standard	78	158	287	586	1196	2454
Fine	53	108	197	402	822	1687

CF card**Image size: L:10M**

(Units: Images)

Size \ Capacity	256MB	512MB	1GB	2GB	4GB
Standard	93	188	377	755	1508
Fine	59	120	242	485	968
RAW & JPEG	12	25	51	103	207
RAW	15	32	65	132	265

Image size: M:5.6M

(Units: Images)

Size \ Capacity	256MB	512MB	1GB	2GB	4GB
Standard	159	319	640	1279	2553
Fine	104	208	419	838	1673

Image size: S:2.5M

(Units: Images)

Size \ Capacity	256MB	512MB	1GB	2GB	4GB
Standard	315	630	1262	2523	5034
Fine	216	433	867	1734	3460

The number of images that can be recorded when using the battery pack

The table shows the approximate number of images that can be recorded when you use the camera with the battery pack (supplied) at full capacity and at an ambient temperature of 25°C (77°F). The numbers of images that can be recorded take into account changing the recording medium as necessary.

Note that the actual numbers may be less than those indicated depending on the conditions of use.

Recording medium	No. of images
“Memory Stick Duo”	Approx. 750
CF card	Approx. 750

- Shooting in the following situations:
 - [Quality] is set to [Fine].
 - [AF mode] is set to [Automatic AF].
 - Shooting once every 30 seconds.
 - The flash strobes once every two times.
 - The power turns on and off once every ten times.
- The measurement method is based on the CIPA standard.
(CIPA: Camera & Imaging Products Association)
- The number of shooting images does not change, regardless of image size.
- The battery capacity decreases as the number of uses increases and also over time (page 142).
- The number of images that can be recorded is decreased under the following conditions:
 - The surrounding temperature is low.
 - The flash is used frequently.
 - The camera has been turned on and off many times.
 - [AF mode] is set to [Continuous AF].
 - The battery power is low.
- When using a Microdrive, the number of images recordable may differ.

Operation workflow

The chart below shows the workflow for the following operations - preparation, shooting, and playback. Perform the following confirmation and setup process, if necessary.

Preparation



- Prepare the battery pack (→ *step 1 in "Read This First"*)
- Attaching a lens (→ *step 2 in "Read This First"*)
- Set the clock (→ *step 3 in "Read This First"*, page 99)
- Insert a recording medium (→ *step 4 in "Read This First"*)



Confirmation before shooting



- Check the recording mode (page 31)
- Adjusting the diopter (→ *step 5 in "Read This First"*)
- Switching the recording information display (page 26)
- Selecting the image size (page 83)
- Using the flash (→ *step 5 in "Read This First"*)

Setup for shooting



- Using the function dial (page 42)
(ISO/Zone Matching, White Balance, D-Range Optimizer, Color Mode, Metering mode, Focus mode, Flash)
- Using the  /  (Drive) button (page 60)
(Single frame advance, continuous advance, self-timer, bracket, white balance bracket)
- Adjusting the exposure (page 65)
- Locking the exposure (page 67)
- Focusing manually (page 71)

Shooting



- Holding the camera (→ *step 5 in "Read This First"*, page 14)
- Look into the viewfinder (→ *step 5 in "Read This First"*)
- When using a zoom lens, turn the zoom ring (→ *step 5 in "Read This First"*)
- Check the focus (→ *step 5 in "Read This First"*)
- Check the approximate sharpness of the subject image (page 70)
- Check that the flash has been charged before you use it (→ *step 5 in "Read This First"*)
- Press the shutter button to take a picture (→ *step 5 in "Read This First"*)

Confirmation of image shot

- Viewing images (→ *step 6 in "Read This First"*)
- Deleting images (→ *step 6 in "Read This First"*)
- Switching the playback screen (page 72)
- Displaying the histogram (page 74)
- Rotating an image (page 76)
- Enlarging images (page 77)
- Viewing images on a TV screen (page 78)

Using the mode dial

Set the mode dial to the desired function.

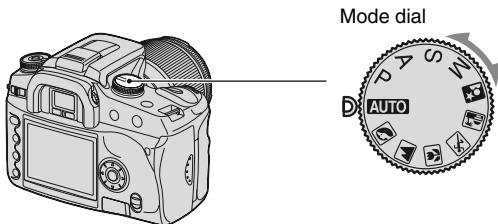

Recording modes

AUTO: Auto adjustment mode

Allows easy shooting with the settings adjusted automatically, depending entirely on the camera. → step 5 in “Read This First”

: Scene Selection mode

Allows you to shoot with preset settings according to the scene (page 32).

P: Program auto mode

Allows you to shoot with the exposure adjusted automatically (both the shutter speed and the aperture value). The other settings can be adjusted, and your setting values can be saved (page 33).

A: Aperture priority mode

Allows you to shoot after adjusting the aperture value manually (page 34).

S: Shutter speed priority mode

Allows you to shoot after adjusting the shutter speed manually (page 36).

M: Manual exposure mode

Allows you to shoot after adjusting the exposure manually (both the shutter speed and the aperture value) (page 37).

In this Operating Instructions, the available mode dial setting is shown as follows.



Unavailable

Available

You can shoot with the following preset settings according to the scene.

- You can change any of the settings except [Color/DEC] (page 49).

Portrait



Shoots with backgrounds blur away, and the subject is sharpened.

- To blur the background more, using the telephoto position of the lens is more effective.
- It is recommended that you use the flash when the subject is backlit. Also, when you do not use the flash, it is recommended that you use the lens hood to prevent unnecessary light from seeping into the lens.

Landscape



Shoots scenery with vivid and sharp colors.

- It is recommended that you push down the flash not to fire the flash.
- The shutter speed becomes slower when the subject is dark. If  appears in the viewfinder, be careful about camera shake or use a tripod. The Super SteadyShot function is also effective.

Macro



Shoots close subjects such as flowers, insects.

You can achieve clear and sharp focus.

- When shooting with the built-in flash within the range of 1 m (39 3/8 inches), shadows may appear on the lower part of the image. Do not use with the built-in flash.
- The minimum recording distance is not changed even if you select Macro. To shoot a larger image, using a macro lens is recommended.

Sports action



Shoots moving subjects outdoors or in bright places.

- The AF mode is set to  (Continuous AF) (page 53). The camera continues to focus while the shutter button is pressed and held halfway down.
- The drive mode is set to Continuous (page 61). The camera shoots the image continuously while the shutter button is pressed.
- Do not use the flash if the subject is out of the flash range (Push the built-in flash back down). Flash range → *step 5 in "Read This First"*

Sunset



Shoots the red of the sunset beautifully.

Night view/portrait

- The shutter speed is slower, so using a tripod is recommended. The Super SteadyShot function is also effective. (→ step 5 in “Read This First”)



Night portrait

Shoots portraits in dark places.

Pull up the flash to use it.

- The shutter speed is up to 2 seconds.
- Take care that the subject does not move to prevent the image from blurring.



Night view

Shoots night scenes at a distance without losing the dark atmosphere of the surroundings.

Do not use the flash (Push the flash back down).

- The picture may not be taken properly when shooting a wholly dark night scene.

Shooting with Program auto



In program auto mode, the camera automatically adjusts the shutter speed and the aperture according to the brightness of the subject just as in the auto adjustment mode (mode dial: AUTO).

Program Shift

You can temporarily change the aperture value and shutter speed combination that was adjusted by the camera.

There are two methods for the program shift function.

P_S shift: You can choose the desired shutter speed. The aperture value is adjusted automatically. This setting is the default setting.

P_A shift: You can choose the desired aperture value. The shutter speed is adjusted automatically.

- You can switch the P_S shift and the P_A shift with [Ctrl dial set] in the  Custom menu (page 94).

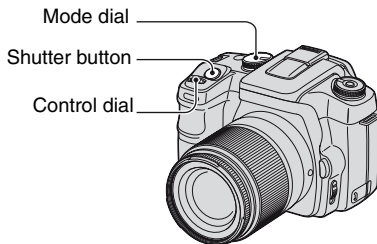

- ① Set the mode dial to P.
- ② Look into the viewfinder or press the shutter button halfway down until the shutter speed and aperture value are displayed on the LCD monitor.

- ③ Select the aperture value or the shutter speed using the control dial when the shutter speed and the aperture value are displayed.

P_S shift (The default setting)

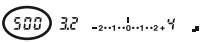

P_A shift

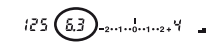
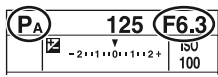

- When the shutter speed and the aperture value are displayed, you no longer have to keep pressing the shutter button.
- When the shutter speed and the aperture value disappear seconds later, the adjusted values also disappear.
- When the flash is pulled up, you cannot select the program shift (even if you turn the control dial, the program shift is not turned on). When the program shift is turned on, pulling up the flash cancels the program shift.

Shooting with aperture priority mode



You can adjust the amount of light that passes through the lens. If you open the aperture (a smaller F-number), the amount of light allowed into the lens increases and the in-focus range becomes narrower. Only the main subject is then in focus. When the aperture is closed (a larger F-number), the amount of light decreases and the in-focus range becomes wider. The whole image is sharpened.

The shutter speed is automatically adjusted to obtain correct exposure according to the brightness of the subject.



Open the aperture



Close the aperture

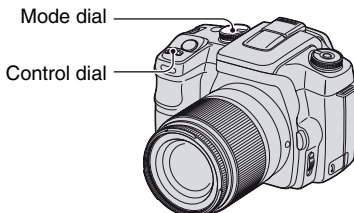

- ① Set the mode dial to A.
- ② Select an aperture value using the control dial.

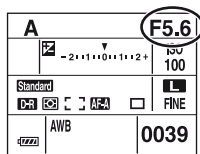

- The aperture range depends on the lens.
- The aperture value is adjusted in 1/3 Ev increments.
- Before shooting, you can do a quick check on the image blur with the depth-of-field preview function (page 70).
- If the proper exposure is not obtained after making the settings, the shutter speed on the LCD monitor and in the viewfinder flashes when the shutter button is pressed halfway down. You can shoot at this point, but adjusting again is recommended.
- When the flash is pulled up, the flash fires regardless of the amount of ambient light (page 54).
- When using the flash, if you close the aperture (a larger F-number), the flash light does not reach a distant subject. Opening the aperture (a smaller F-number) is recommended.
- If you close the aperture (a larger F-number), the amount of light passing through the lens is decreased and the shutter speed becomes slower. Using a tripod is recommended.

💡 Shooting techniques

The depth of field is the in-focus range. Opening the aperture makes the depth of field shallower (the in-focus range becomes narrower) and closing the aperture makes the depth of field wider (the in-focus range becomes wider).

Open the aperture

The subject is sharpened with its background blurred.



Close the aperture

Over a wide range, both nearby and faraway subjects are brought into focus.



Adjust the aperture to suit your purpose, either to sharpen the specific area of image, or to focus on the entire image.

You can adjust the shutter speed manually. If you shoot a moving subject at a higher shutter speed, it appears as if frozen on the image. At a lower shutter speed, the subject appears as if it flowing.

Aperture value is automatically adjusted to attain correct exposure according to the brightness of the subject.









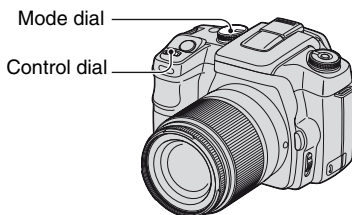



High shutter speed



Slow shutter speed



- ① Set the mode dial to S.
- ② Select a shutter speed using the control dial.

S	500	ISO 100
	-2+1+1+0+1+1+2+	
Standard	  	 FINE
   	<input type="checkbox"/>	
 AWB	0039	

- You can adjust the shutter speed between 30 and 1/4000 second. You can adjust it between 30 and 1/125 second (with the Super SteadyShot function activated) or 30 and 1/160 second (with the Super SteadyShot function deactivated) when using the flash.
- The shutter speed is adjusted in 1/3 Ev increments.
- If the proper exposure is not obtained after making the settings, the aperture value on the LCD monitor and in the viewfinder flashes when the shutter button is pressed halfway down. You can shoot at this point, but adjusting again is recommended.
- When the flash is pulled up, the flash fires regardless of the amount of ambient light (page 54).
- When using the flash, if you close the aperture (a larger F-number) by making the shutter speed slower, the flash light does not reach a distant subject. If you want to use the slower shutter speed, the Slow Sync shooting is recommended (page 69).
- When the shutter speed is one second or more, the noise reduction will be done after shooting (page 85).
- The  (Camera-shake warning) indicator does not appear in the shutter speed priority mode.

Shooting techniques



When shooting a moving person, car, or spindrift, etc., using the high shutter speed, you can express moment that is beyond what the human eye can see.



When shooting a subject such as the flow of a river at a slower shutter speed, you can create an image that captures the subject's flowing movement. In such cases, use of a tripod is recommended to prevent camera shake.

Shooting with manual exposure mode



Manual exposure

You can manually adjust the shutter speed and aperture values.

This mode is useful when you maintain the setting of the shutter speed and the aperture value or when you use an exposure meter.

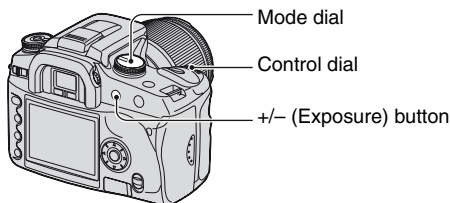



- ① Set the mode dial to M.
- ② Select a shutter speed using the control dial.

M	500	F5.6
M	-2 +1 +0 +1 +2 +	ISO 100
Standard	☺ □ AF-A □	FINE
AWB	0039	

• “BULB” (Bulb shooting) is indicated next to “30” (page 40).







- ③ Press and hold the +/- (Exposure) button and turn the control dial to select the aperture.

M	500	F4.5
M	-2 +1 +0 +1 +2 +	ISO 100
Standard	☺ □ AF-A □	FINE
AWB	0039	

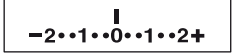
- In the manual exposure mode, even when [ISO] (page 44) is set to [AUTO], it is fixed to ISO 100.
- You can assign the function of the control dial with [Ctrl dial set] in the  Custom menu (page 94).
- The  (Camera-shake warning) indicator does not appear in the manual exposure mode.
- When the flash is pulled up, the flash fires regardless of the amount of ambient light (page 54).

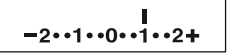
Ev scale

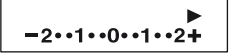
The Ev scale on the LCD monitor and in the viewfinder indicates the difference between the standard exposure (0.0Ev) determined by the camera meter and the set exposure determined by the shutter speed, and the aperture specified by the photographer. (Metered Manual)

Standard exposure	1.0Ev over exposure	2.0Ev or more over exposure
 	 	 
<p>The set exposure specified by the photographer is the same as the exposure determined by the meter.</p>	<p>The set exposure specified by the photographer is 1.0Ev more (+) than the standard exposure determined by the meter.</p>	<p>The  arrow appears at the end of the scale if the set exposure is over 2.0Ev more (+) or less (-) than the standard exposure. The arrow starts flashing if the difference becomes greater.</p>

 : stands for Metered Manual.

💡 How to use the AEL button in manual mode

While you press and hold the AEL (AE Lock) button, the exposure determined by the meter is locked as the standard exposure (0.0Ev). Changing the composition on the LCD monitor and in the viewfinder while holding the AEL button causes the exposure within the spot metering circle to continually shift to match the movements and the display indicates the difference between the standard exposure determined by the meter and the exposure within the spot metering circle.

The following illustrations show a case where the set exposure specified by the photographer is 1.0Ev more than the locked standard exposure determined by the meter. When the composition is changed in the viewfinder, the exposure within the spot metering circle is 0.7Ev more than the set exposure, thereby making it 1.7Ev more than the standard exposure determined by the meter.

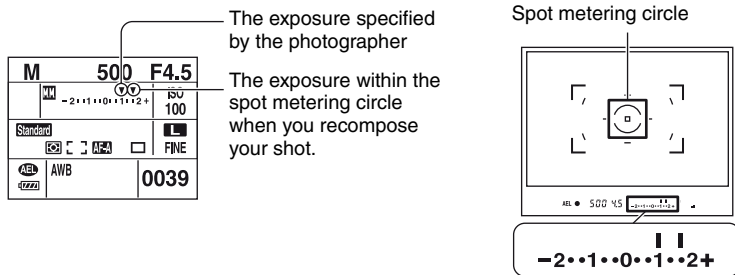

Manual shift

You can change the shutter speed and aperture value combination without changing the exposure in manual mode.

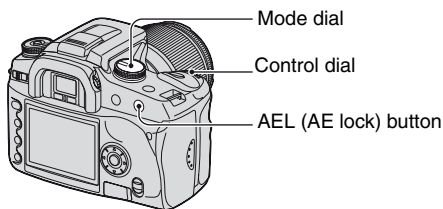

- ① Set the mode dial to M.
- ② Select a shutter speed and aperture value (page 37).
- ③ Press and hold the AEL (AE lock) button and turn the control dial to select the desired shutter speed and aperture value combination.

BULB (long exposure) shooting

As long as the shutter button is pressed, the shutter remains open. You can shoot trails of light, such as fireworks. Attach a tripod to the camera when using the bulb shooting function.

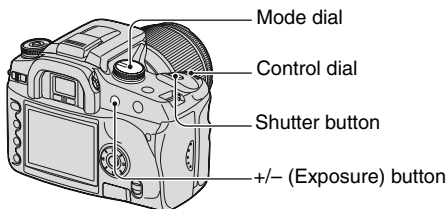

- ① Set the mode dial to M.
- ② Turn the control dial to the left until [BULB] is indicated.

M	BULB	F5.6
	-2+1+0+1+2+	ISO 100
Standard		FINE
		0039

- ③ Press and hold the +/- (Exposure) button and turn the control dial to select the aperture.
 - ④ Attach the eyepiece cover (page 41).
 - ⑤ Press and hold the shutter button for the duration of the shooting.
- You can shoot in bulb exposure mode up to about four hours using a fully charged battery pack.
 - After shooting, the noise reduction will be done for the same amount of time that the shutter was open. When the message “Processing...” appears, you cannot do any further shooting. To cancel this function, see page 85.
 - The Super SteadyShot function is automatically turned off.
 - The higher the ISO sensitivity, or the longer the exposure time, the more outstanding the noise on the monitor.
 - To reduce camera-shake, connecting the Remote Commander (not supplied) is recommended (page 144).

To attach the eyepiece cover

When the shutter is released without the use of the viewfinder, as in bulb exposure or shooting with the self-timer, attach the eyepiece cover to prevent light from entering through the viewfinder and affecting the exposure.

- ① Carefully slide the eyecup off by pushing on each side of the eyecup.

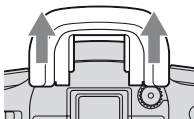

- ② Slide the eyepiece cover over the viewfinder. The cover is normally attached to the shoulder strap.

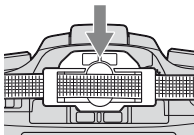

- When attaching the eyepiece cover, the eyepiece sensors located below the viewfinder may be activated depending on the situation, and the focus may be adjusted or the LCD monitor may continue to flash. Setting [Eye-Start AF] to [Off] prevents this problem (page 85).

Using the function dial

Set the function dial to the desired function. You can set the focus frame, AF mode, metering mode, flash compensation, color mode, etc.

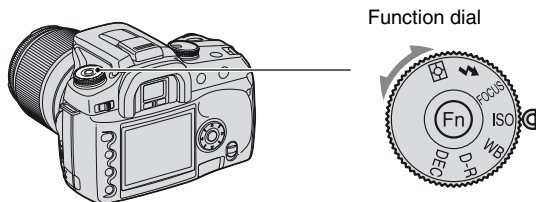

- ISO:** Setting ISO/Zone Matching (page 44)
- WB:** Adjusting the white balance (page 46)
- D-R:** D-Range Optimizer (page 49)
- DEC:** Selecting the color/DEC mode (page 49)
- FOCUS:** Focus mode (page 51)
- ⚡:** Flash (page 54)
- ☉:** Metering mode (page 58)

How to use the function dial

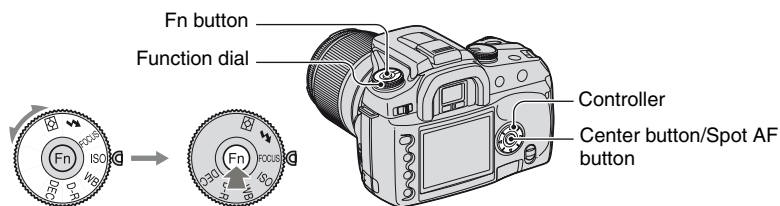

1 Set the function dial to the desired position.

2 Press the Fn button so that the function screen appears.

3 Select the desired setting or value with $\blacktriangle/\blacktriangledown/\blacktriangleleft/\blacktriangleright$ on the controller.

- You can substitute the control dial for $\blacktriangleleft/\blacktriangleright$ of the controller.
- For details on the setting method, see the corresponding explanation.

4 Press the center button of the controller to complete the operation.

The settings you select are set.





You can adjust the ISO sensitivity and switch the Zone Matching setup.

ISO

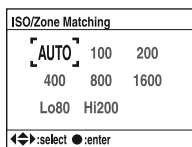
ISO is a unit of measurement of sensitivity to light. The larger the number, the higher the sensitivity.

- ① Display the ISO/Zone Matching screen with the function dial and the Fn button (page 43).



- ② Select the desired value with /// on the controller, then press the center of the controller.
- [Hi200] and [Lo80] options are used for Zone Matching (page 45).

(: The default setting)

	AUTO	Automatically adjusts the ISO sensitivity.
	100	Select a large number when shooting in dark locations or shooting a subject moving at high speed, or select a small number to obtain high image quality.
	200	
	400	
	800	
	1600	

- When [ISO] is set to [AUTO], the ISO sensitivity is automatically adjusted between ISO 100 and ISO 800, however, if the mode dial is set to M, it is fixed at ISO 100.
- The built-in flash range (the range within which the correct exposure is provided) depends on the aperture value and ISO sensitivity. Refer to the following table to determine the shooting distance.

Aperture	ISO setting				
	100	200	400 / AUTO	800	1600
F2.8	1 – 4.3 m (39 3/8 – 169 3/8 inches)	1 – 6 m (39 3/8 – 236 1/4 inches)	1.4 – 8.6 m (55 1/8 – 338 5/8 inches)	2 – 12 m (78 3/4 – 472 1/2 inches)	2.8 – 17 m (110 1/4 – 669 3/8 inches)
F4.0	1 – 3 m (39 3/8 – 118 1/8 inches)	1 – 4.3 m (39 3/8 – 169 3/8 inches)	1 – 6 m (39 3/8 – 236 1/4 inches)	1.4 – 8.6 m (55 1/8 – 338 5/8 inches)	2 – 12 m (78 3/4 – 472 1/2 inches)
F5.6	1 – 2.1 m (39 3/8 – 82 3/4 inches)	1 – 3 m (39 3/8 – 118 1/8 inches)	1 – 4.3 m (39 3/8 – 169 3/8 inches)	1 – 6 m (39 3/8 – 236 1/4 inches)	1.4 – 8.6 m (55 1/8 – 338 5/8 inches)

Zone Matching

You can keep the image from becoming overexposed or underexposed when shooting a high-keyed or low-keyed subject.

This function is also available for a RAW file.

- ① Display the ISO/Zone Matching screen with the function dial and the Fn button (page 43).

ISO/Zone Matching		
AUTO	100	200
400	800	1600
Lo80	[Hi200]	
◀▶:select ●:enter		

- ② Select [Lo80] or [Hi200] with ▲/▼/◀/▶ on the controller, then press the center of the controller.
- [AUTO], [100], [200], [400], [800] and [1600] options are used for ISO sensitivity (page 44).

Lo80	This keeps the image from becoming underexposed. Use in low-key (predominantly dark) scenes is recommended, as the image tends to become whitish.
Hi200	This keeps the image from becoming overexposed. Use in high-key (predominantly light) scenes is recommended, as the image tends to have heightened noise level.

- The ISO sensitivity is set to the equivalent of ISO 80 in [Lo80], and of ISO 200 in [Hi200].
- When zone matching is used, the contrast setting in the color mode is deactivated.
- Refer to the following table to determine the flash range.

Aperture	Zone Matching	
	Lo80	Hi200
F2.8	1 – 3.8 m (39 3/8 – 149 5/8 inches)	1 – 6 m (39 3/8 – 236 1/4 inches)
F4.0	1 – 2.7 m (39 3/8 – 106 3/8 inches)	1 – 4.3 m (39 3/8 – 169 3/8 inches)
F5.6	1 – 1.9 m (39 3/8 – 74 7/8 inches)	1 – 3 m (39 3/8 – 118 1/8 inches)

Adjusting the white balance

FOCUS ISO WB D-R DEC

Normally, the camera automatically adjusts the color tones. However, you can also adjust them according to the lighting conditions.

- ① Display the White-balance mode screen with the function dial and the Fn button (page 43).

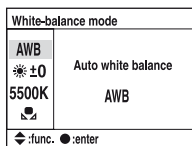

- ② Select the desired white balance mode with ▲/▼ on the controller.
- ③ To select [AWB], press the center of the controller.
To select anything other than [AWB], go to each procedure.

AWB (Auto white balance)	Adjusts the white balance automatically.
☀️ (Preset white balance)	Adjusts the white balance to a specific light source (see below).
K* (Color temperature)	Adjusts color temperature. The CC (Color Compensating) filter is also adjusted (page 47).
👤 (Custom white balance)	Memorizes the basic white color (page 48).

* K: stands for "Kelvin" (unit of color temperature)

Preset white balance

Select an option to suit a specific light source. Use this function if you cannot get your desired color in [AWB].

- ① Display the White-balance mode screen with the function dial and the Fn button (page 43).
- ② Display the Preset white balance screen with ▲/▼ on the controller, then press ▶.

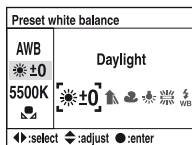

- ③ Select the desired light source with ◀/▶ on the controller or the control dial, then make fine adjustments with ▲/▼ on the controller, if necessary.
 - You can adjust the white balance between +3 and -3 (in Fluorescent, between +4 and -2).
 - Adjusting toward + increases the color temperature and the image turns reddish. Adjusting toward - decreases the color temperature and the image turns paler.
 - 1 step is equivalent to approximately 10 mired*.
- * Mired: a unit to indicate the color conversion quality in color temperature filters.

- ④ Press the center of the controller.

(✓): The default setting)

✓	☀ (Daylight)	Adjusts for outdoors, sunlit subjects.
	☷ (Shade)	Adjusts for shady conditions on a clear day.
	☁ (Cloudy)	Adjusts for a cloudy sky.
	☀ (Tungsten)	Adjusts for places where the lighting conditions change quickly, such as at a party hall, or under bright lighting, such as at photography studios.
	☾ (Fluorescent)	Adjusts for fluorescent lighting.
	⚡ (Flash)	Adjusts for flash condition.

- For details on the white balance → page 17
- If the ambient light consists of sodium-vapor lamps or mercury-vapor lamps alone, an accurate white balance cannot be acquired due to the properties of the light source. Use of the flash is recommended to overpower the ambient light.

Color temperature

You can set the white balance using a color temperature.

Based on using the set color temperature as the standard, the color can be compensated from G (Green) to M (Magenta) just like using a CC (Color Compensation) filter for photography.

- When setting the color temperature measured by the color meter, test shooting is recommended before the actual photo is taken.

- ① Display the White-balance mode screen with the function dial and the Fn button (page 43).
- ② Display the Color temperature screen with ▼ on the controller, then press ►.

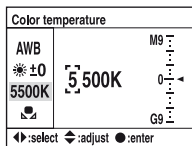

- ③ Set the color temperature with ▲/▼/◀/▶ on the controller.
 - Select the digit (thousand's or hundred's place) of the color temperature with ◀/▶, then set the value of the selected digit with ▲/▼.
 - The color temperature can be selected between 2500K and 9900K.
- ④ Select the setup area of the CC filter with ►, then set the CC filter with ▲/▼, if necessary.

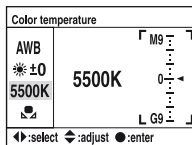

- Pressing ▲ compensates toward M (Magenta), and pressing ▼ toward G (Green). This compensation can adjust among nine steps in each direction.
 - The increment on the scale is equivalent to approximately 5CC.
- ⑤ Press the center of the controller.
 - If you change the color temperature after adjusting the CC filter, the actual CC filter value reflects the new color temperature.

Custom white balance

In a scene where the ambient light consists of multiple types of light source, use of custom white balance is recommended in order to accurately reproduce the whiteness.

- ① Display the White-balance mode screen with the function dial and the Fn button (page 43).
- ② Display the Custom white balance screen with ▲/▼ on the controller, then press ►.

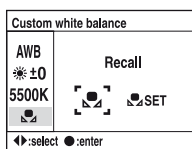

- ③ Select [SET] with ► on the controller, then press the center of the controller. The message “Use spot metering area. Press shutter to calibrate.” appears on the LCD monitor.
- ④ Hold the camera so that the white area fully covers the spot-metering circle and press the shutter button down. The shutter clicks and the calibrated values (Color temperature and CC) are displayed.
 - The focus does not have to be confirmed.
- ⑤ Press the center of the controller. The monitor returns to the recording information screen with the memorized custom white balance setting retained.

To call the custom white balance setting

In step ② above, select [SET] with ◀/▶, then press the center of the controller.

- The custom white balance setting registered in this operation is effective until a new setting is registered. (The setting is retained after the power is turned off.)
- If the flash is used when the shutter button is pressed, a custom white balance is registered with the flash light taken into account. Take pictures with the flash in later shootings.
- The message “Custom WB error.” indicates that the value is beyond the expected range. (When the flash is used on a subject in close proximity or a subject with a bright color is in the frame.) The value is registered and the SET indicator turns yellow on the recording information display on the LCD monitor. You can shoot at this point, but it is recommended that you set the white balance again to get a more correct white balance value.

D-Range Optimizer



The camera analyzes the shooting conditions and automatically corrects the image to improve the image quality.

- 1 Display the D-Range Optimizer screen with the function dial and the Fn button (page 43).

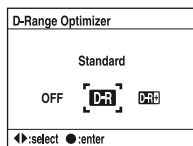

- 2 Select the desired mode with ◀▶ on the controller, then press the center of the controller.

(✔: The default setting)

	OFF (Off)	Does not correct brightness or contrast.
✔	D-R (Standard)	Adjusts the brightness and contrast of the whole screen.
	D-R (Advanced)	Optimizes the contrast and the color reproduction of the recorded image by area.

- There is no effect in the following cases.
 - Center weighted metering
 - Spot metering
 - The mode dial is set to M.
 - [Quality] is set to [RAW] or [RAW & JPEG].
- When using AE lock, the camera automatically corrects the locked image.
- When in Continuous advance mode, the correction is fixed onto the first image, the same correction is used for the second or later images.

Selecting the color/DEC mode



The color mode has combinations of color tone, white balance, contrast, saturation, and sharpness that are best for various shooting conditions and purposes. This function is useful if you want to use the effects of scene selection when the mode dial is set to P, A, S, or M. Within the color mode, the contrast, saturation, and sharpness can be further calibrated to your liking.

- 1 Display the Color/DEC screen with the function dial and the Fn button (page 43).

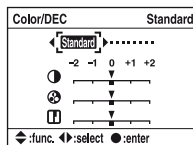

- 2 Select the desired color mode with ◀▶ on the controller.

- ③ When adjusting the contrast, saturation, or sharpness, move to the screen used for adjustments with **▼**, select the desired item with **▲/▼**, then adjust the value with **◀/▶**.
- ④ Press the center of the controller.

(✔: The default setting)

✔	Standard (Standard)*	Reproduces various scenes with rich gradation and beautiful color.
	VIVID (Vivid)*	Reproduces memorable scenery such as blue sky, sunsets, spring greenery, and autumn leaves with deep and vivid colors.
	Portrait (Portrait)*	Accentuates the subject and softly reproduces skin tones.
	Land (Landscape)*	Reproduces the scenery with vivid and sharp colors.
	Sun (Sunset)*	Beautifully reproduces the red of the sunset.
	Night (Night view)*	Reproduces the light area vividly and the dark area crisply.
	B/W (B&W)	For monochrome images.
	Adobe (Adobe RGB)	Uses the Adobe RGB color space. An ICC profile will not be embedded in the image.

* Uses the sRGB color space (see below).

(Contrast)	Adjusts the contrast in five steps, from -2 to +2. The higher the value, the stronger the contrast, resulting in a well-modulated, clear image. The lower the value, the weaker the contrast, resulting in fewer instances of white out or black out. <ul style="list-style-type: none"> • When setting the zone matching, only the contrast setting is temporarily reset to 0 and cannot be changed.
(Saturation)	Adjusts the color saturation in five steps, from -2 to +2. The higher the value, the stronger the saturation, resulting in a vivid, clear image. A lower value results in an understated image. <ul style="list-style-type: none"> • If the color mode is set to B/W (B&W), the saturation cannot be adjusted.
(Sharpness)	Adjusts the sharpness of the image in five steps, from -2 to +2. The higher the value, the sharper the outline, resulting in a vivid, clear image. The lower the value, the softer the outline.

- Selecting auto white balance (page 46) produces a more effective color tone. Use auto white balance especially in Sunset mode.

🔍 About sRGB color space and Adobe RGB color space

sRGB color space

This is the standard color space of the digital camera and suitable for almost all normal conditions. As it is the color space that accommodates the properties of the average monitor, sRGB is also suited for handling images for use in web pages.

Adobe RGB color space

Adobe RGB color space has a wide range of color reproduction, compared to sRGB. If the main purpose is to print out the image, especially when a large part of the subject is vivid green or red, Adobe RGB is more effective than other sRGB color modes.

- The file name of the image starts with “_DSC” (page 112).

🔧 About color matching in Adobe RGB

To display or print the image, use software that supports color management, such as “Picture Motion Browser” (supplied).

To display, edit, modify, or print an image captured in Adobe RGB mode, use an application such as “Picture Motion Browser”, that supports color management and DCF2.0 option color space. Software without color management functions, may not display or print Adobe RGB images with faithful colors. To print the image with faithful colors, the printer needs to be DCF2.0 option color space compliant.

Focus mode



You can set the AF area and the AF mode.

- When shooting in auto focus mode, be sure to set the focus mode switch to AF.

AF area

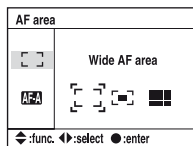

You can change the focus method. Change the method when it is difficult to get the proper focus.

- ① Display the focus mode screen with the function dial and the Fn button (page 43).
- ② Display the AF area screen with ▲ on the controller.



- ③ Select the desired mode with ◀▶ on the controller, then press the center of the controller.

(✔: The default setting)

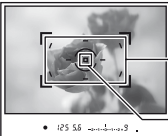
✔	[] (Wide AF area)	<p>The camera determines which of the nine local focus frames is used in focusing within the wide focus frame.</p>  <p>Wide focus frame</p> <ul style="list-style-type: none">• When you press the shutter button halfway down, the frame used in focusing is illuminated briefly.• You can switch to spot focus frame if the desired frame is not used in focusing. Press the spot AF button at the center of the controller to focus the center of the screen, and press the shutter button all the way down without releasing the spot AF button on the controller to take a picture.
	[] (Spot AF area)	<p>The camera uses the spot focus frame exclusively.</p>  <p>Spot focus frame</p> <ul style="list-style-type: none">• When you look into the viewfinder, the spot focus frame is illuminated briefly.
	[] (Focus area selection)	<p>Choose a local focus frame from the nine frames. Press the corresponding one of the controller, and the local focus frame in the specified direction is used in focusing. (Eight directions are available.) Press the spot AF button at the center to use the spot focus frame in focusing.</p>  <p>Local focus frame</p> <p>Spot focus frame</p> <ul style="list-style-type: none">• When you look into the viewfinder, the selected focus frame is illuminated briefly.• After shooting, frame selection is still available. Be sure not to press the controller unless it is necessary.

- While the controller or the spot AF button is held down, the focus stays locked. If the controller or the Spot AF button is kept down after shooting, you can continue shooting with the same focus.
- When multi-segment metering is used, the exposure is locked at the same time as the focus is locked.
- In wide AF area mode, you can press the controller to focus. To shoot with that focus, press the shutter button without releasing the controller. The direction of the controller you press does not affect the frame used in focusing.
- In spot AF area mode, you can focus by pressing either the controller or the spot AF button. If you press any direction key of the controller, the spot focus frame is always activated. To shoot with that focus, press the shutter button without releasing the controller or the spot AF button.
- The local focus frame may not be illuminated when continuous shooting is performed or when the shutter button is pressed all the way down without pause.

AF mode

Selects the auto focus operation mode.

- ① Display the focus mode screen with the function dial and the Fn button (page 43).
- ② Display the AF mode screen with ▼ on the controller.

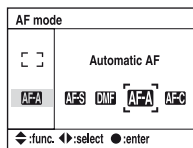

- ③ Select the desired mode with ◀▶ on the controller, then press the center of the controller.

(✔: The default setting)

AFS (Single-shot AF)	In this AF mode, the focus is locked when you press the shutter button halfway down. This mode is used when shooting a motionless subject.
DMF (Direct Manual Focus)	In this AF mode, you can manually fine-tune the focus after using the autofocus function. This mode is used when an unwanted subject comes into focus in macro recording, etc.
AFA (Automatic AF)	This AF mode automatically switches between single-shot AF and continuous AF, depending on the subject's motion. If the subject is in motion, the camera continues to focus while the shutter button is pressed and held halfway down. If the subject is motionless, the focus is locked when the shutter button is pressed and held halfway down. This is a general purpose AF mode suitable for portraits, group pictures, snapshots, landscapes, etc.

A-C (Continuous AF)	<p>In this AF mode, the camera continues to focus while the shutter button is pressed and held halfway down. This mode is used when the subject is in motion.</p> <ul style="list-style-type: none"> • If the wide AF area is selected, the focus frame switches to match the position of the subject. The frame in focus turns red and starts flashing. • The buzzer will not sound when the subject is in focus.
----------------------------	--

To make a fine adjustment in **DMF** (Direct Manual Focus)

- ① Select **DMF** (Direct Manual Focus) in AF mode.
- ② Press the shutter button halfway down to lock the focus.
- ③ Turn the focusing ring to fine-tune the focus while pressing the shutter button halfway down.

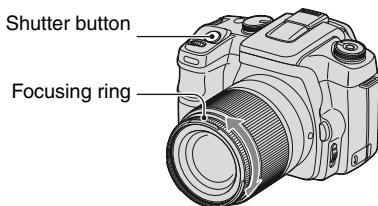

- ④ Press the shutter button fully down.
- Once you release your finger from the shutter button, the focus lock operation starts again from the beginning when you press the shutter button halfway down.

Flash	☐ ⚡ FOCUS ISO WB D-R DEC
--------------	--

Sets up the flash mode and the flash compensation.

Flash mode

If the built-in flash is pulled up, the flash automatically fires when the surroundings are dark (the default setting). You can intentionally change the flash mode.

- ① Display the flash mode screen with the function dial and the Fn button (page 43).

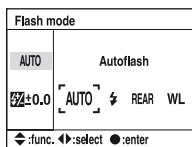

- ② Display the Flash mode screen with ▲ on the controller.
- ③ Select the desired mode with ◀▶ on the controller, then press the center of the controller.

- The flash indicator is displayed only when the flash is pulled up.

(✔: The default setting)

✔	AUTO (Autoflash)	Fires if it is dark or against light. • This is not selectable when the mode dial is set to A, S, or M.
	⚡ (Fill-flash)	Fires whenever the built-in flash is pulled up.
	REAR (Rear sync.)	Ordinarily, the flash is fired right after the shutter has been released, then objects illuminated by other light sources are captured. This causes certain subjects, such as trailing light, to appear unnatural when the slower shutter speed is used. In rear sync mode, the objects illuminated by other light sources are captured first, then the flash is fired. You can capture a flowing light or the trail of a moving subject in a more realistic way when shooting a moving subject using a slower shutter speed with the flash. 
	WL (Wireless)	Using the built-in flash or an external flash (not supplied) mounted on the camera may make certain pictures appear too flat. In such a case, an off-camera flash in a proper position can create more contrast, resulting in a more three-dimensional picture. Generally, this type of shooting requires the camera and an off-camera flash to be connected with a cable. This camera can do this without a cable because it uses the flash light instead of the cable to transmit the signal. This is called wireless flash shooting. The exposure is automatically adjusted to the optimal exposure. • Wireless flash shooting requires the flash HVL-F56AM or HVL-F36AM (not supplied).

To perform wireless flash shooting

- ① Attach the external flash to the camera (page 145) and turn on the camera and the external flash.
- ② Select **WL** (Wireless).
- ③ Remove the external flash from the camera and pull up the built-in flash on the camera. “WL” appears in the viewfinder and on the LCD monitor.
- ④ Determine the position of the camera and the external flash.
- ⑤ Make sure the built-in flash and the external flash are fully charged.
 - The built-in flash is fully charged when ⚡ appears in the viewfinder.
 - The external flash is fully charged when ⚡ appears on the back of the external flash and the red lamp flashes on the front of the flash.

- ⑥ Press the AEL (AE Lock) button on the camera to test fire the flash.
 - If the flash does not fire, change the camera, external flash, or subject position.
- ⑦ Check both flashes again to make sure they are fully charged. Press the shutter button to take a picture.
 - Turn off the wireless flash mode after wireless flash shooting. (You can either deactivate the camera and the external flash separately, or you can attach the external flash to the camera and select a different flash mode, as shown on page 54). If the built-in flash is used while the wireless flash mode is still active, inaccurate flash exposures will result.
 - You can select the wireless setting on the camera and the external flash separately. See page 54 to set the camera. To set the external flash, refer to the operating instructions supplied with it.

If the operation and the function of the AEL (AE Lock) button has been changed

When using the wireless flash, it is recommended that you set [AEL button] (page 93) to [AE hold] or [AE hold] in the  Custom menu.

If you select a setting that is retained after the button has been released ([AE toggle]/[AE toggle]) the camera is in slow sync recording mode while “AEL” appears in the viewfinder and on the LCD monitor. Every test fire will cause the slow sync recording mode to switch on and off.

About the position of the camera and the flash

This camera uses the flash light of its built-in flash to send a signal to the off-camera flash to fire. Take note of the following points to ensure proper transmission of the signal.

- Wireless flash shooting should be performed in a dark environment such as indoors, etc.
- Place the external flash in the grey area as illustrated below.

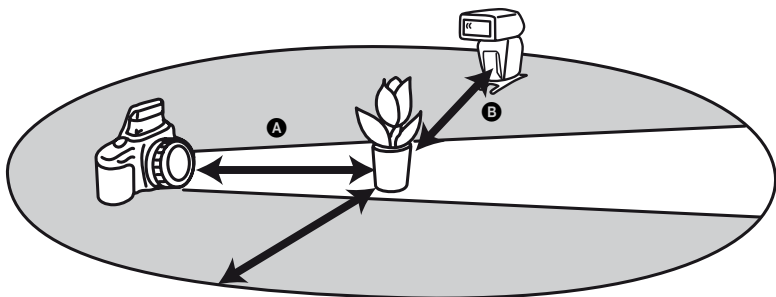

- A**: The distance between the camera and the subject
 - B**: The distance between the external flash and the subject
- Do not place the external flash directly behind the subject.

Specifications with wireless flashes at ISO 100

Shutter Speed Aperture	Camera-to-subject distance A	Flash-to-subject distance B HVL-F56AM			Flash-to-subject distance B HVL-F36AM		
	All shutter speeds	Up to sync speed	1/250	1/1000	Up to sync speed	1/250	1/1000
F2.8	1.4 – 5 m (55 1/8 – 196 7/8 inches)	1 – 5 m (39 3/8 – 196 7/8 inches)	1 – 5 m (39 3/8 – 196 7/8 inches)	1 – 2.5 m (39 3/8 – 98 1/2 inches)	1 – 5 m (39 3/8 – 196 7/8 inches)	1 – 4 m (39 3/8 – 157 1/2 inches)	1 – 2 m (39 3/8 – 78 3/4 inches)
F4.0	1 – 5 m (39 3/8 – 196 7/8 inches)	1 – 5 m (39 3/8 – 196 7/8 inches)	1 – 3.5 m (39 3/8 – 137 7/8 inches)	1 – 1.7 m (39 3/8 – 67 inches)	1 – 5 m (39 3/8 – 196 7/8 inches)	1 – 3 m (39 3/8 – 118 1/8 inches)	1 – 1.5 m (39 3/8 – 59 1/8 inches)
F5.6	1 – 5 m (39 3/8 – 196 7/8 inches)	1 – 5 m (39 3/8 – 196 7/8 inches)	1 – 2.5 m (39 3/8 – 98 1/2 inches)	1 – 1.2 m (39 3/8 – 47 1/4 inches)	1 – 5 m (39 3/8 – 196 7/8 inches)	1 – 2 m (39 3/8 – 78 3/4 inches)	–

- The camera's flash sync speed is 1/125 second with the Super SteadyShot function on and 1/160 second with the Super SteadyShot function off.
- Double the maximum distance when using the camera sensitivity at ISO 400. The maximum distance is 5 m (16.4 ft.).

🔦 About the wireless flash channels

As soon as the wireless flash is selected, the channel information of the external flash is transferred to the camera. Change the channel of the external flash when another photographer is using a wireless flash nearby and his/her built-in flash light triggers firing of your flash.

To change the channel of the external flash, refer to the operating instructions supplied with it.

Flash compensation

When shooting with the flash, you can adjust the amount of flash light alone, without changing the exposure compensation. You can change the exposure of a subject which is within the flash range, while leaving the exposure of the background, which is out of the flash range, as it is.

- ① Display the Flash mode screen with the function dial and the Fn button (page 43).
- ② Select the Flash compensation with ▼.

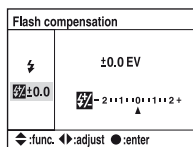

- ③ Select the desired value with ◀▶ on the controller, then press the center of the controller.

(✔: The default setting)

	to +2.0 EV	Toward +: Makes the flash level higher.
✔	0 EV	The amount of flash light that the camera adjusts automatically.
	to -2.0 EV	Toward -: Makes the flash level lower.

- You can set the degree of compensation in 1/3 increments.
- When the built-in flash is pulled up, the set flash compensation value is displayed below the Ev scale on the LCD monitor.
- When you press the shutter button halfway down,  appears in the viewfinder.
- When performing flash compensation with the built-in flash, the positive effect may not be visible due to the limited amount of flash light, if the subject is at or around the maximum distance for the flash. If the subject is very close, the negative effect may not be visible.

Exposure compensation and Flash compensation

Exposure compensation changes the shutter speed, aperture, and ISO sensitivity (when [AUTO] is selected) to perform the compensation. If the flash is used, the amount of flash light is also changed.

On the other hand, Flash compensation only changes the amount of flash light, thereby controlling the relative effect of the flash light on the whole picture. For instance, if you want to reduce the flash light, you can set the flash compensation on the slightly negative side and at the same time set the exposure compensation on the positive side to adjust the brightness of the entire picture.

- You can keep the amount of flash light from changing with the exposure compensation (page 95).



Metering mode



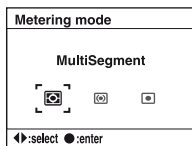

You can select a metering mode (a method whereby the camera measures the brightness of a subject) from the following three methods.

- ① Display the Metering mode screen with the function dial and the Fn button (page 43).



- ② Select the desired mode with   on the controller, then press the center of the controller.

(✔: The default setting)

✔	 (MultiSegment)	This divides the whole screen into 40 segments to measure light (40-segment honeycomb pattern metering).
	 (Center weighted)	While emphasizing the central area of the screen, this mode measures the average brightness of the entire screen. If you shoot directly into the sun light or the subject is not in the center of the image, you must use exposure compensation (page 65).

☐ (Spot)

This mode measures light only in the spot metering circle in the center of the frame. This is suitable for shooting a subject with strong contrast or measuring the light of a specific area of the screen. If the area to be measured is not in the center of the screen, use AE lock to take the picture (page 67).



Spot metering area
Position of the subject.

☐ Multi-segment metering (40-segment honeycomb pattern metering)

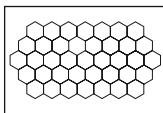

This camera divides the screen into 40 segments to measure light; 39 honeycomb shaped metering elements and one metering element that covers the surrounding area. These elements work in sync with autofocus, allowing the camera to accurately measure the position and brightness of the subject no matter where it is on the screen in order to determine the exposure. This metering method enables the camera to measure light in a way most similar to that of the human eye, which is ideal for general shooting, including shooting into direct sunlight.



- In multi-segment metering (40-segment honeycomb pattern metering), if the focus is locked by pressing and holding the shutter button halfway down, the exposure (the shutter speed and the aperture) is locked simultaneously (only when autofocus is used and the AF mode is set to either **AF-S** (Single-shot AF) or **AF-A** (Automatic AF)).



Using the / (Drive) button

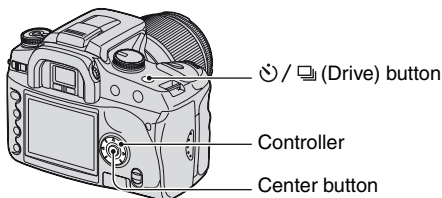

How to use the / (Drive) button

You can use continuous shooting, self-timer, bracket, white balance bracket with the  /  (Drive) button.





1 Press the  /  (Drive) button.

2 Select the desired mode with  /  on the controller.

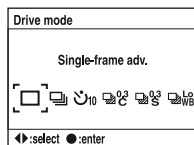
- You can substitute the control dial for  /  of the controller.





3 Select the desired mode with  /  on the controller.

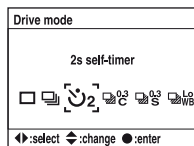





- This setup is not required in single-frame or continuous advance.



4 Press the center button of the controller to complete the operation.

- If you press the  /  button or press the shutter button halfway down, the setting is completed.

(✔: The default setting)

✔		Single-frame advance • Also used as the cancel button for other drive modes.
		Continuous advance (see below)
		Self-timer (page 62)
		Continuous bracket (page 62)
		Single bracket (page 63)
		White balance bracket (page 64)

Shooting continuously

When you press and hold the shutter button, the camera records the images continuously at a maximum of three images per second*.

* Our measurement conditions: [Image size] is set to [L:10M], [Quality] is set to [Fine], manual focus, and the shutter speed is 1/250 second or faster.

- The number of frames that can be shot continuously is indicated in the viewfinder, and when shooting continuously, this number decreases.
After the images have been recorded on the recording medium, the number returns to the original number, depending on the camera memory buffer.

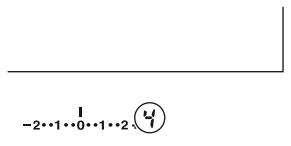

- When the built-in flash is fired, images are shot after the flash has been charged.
- When [AF mode] is set to **AF-C** (Continuous AF) or **AF-A** (Automatic AF), the focus is set separately on each image. When set to **AF-S** (Single-shot AF), the focus is fixed on the first image.
- The last image is displayed in instant playback.
- The number of continuous shooting images obtainable has an upper limit.

The maximum number of continuous shots

Fine/Standard	No limit* (Until the recording medium is full)
RAW & JPEG	3 images
RAW	6 images

* When [Image size] is set to [M:5.6M] or [S:2.5M], the shooting speed is slightly slower when shooting the fourth and following images.



- These numbers depend on the writing speed of a recording medium, the shooting condition, etc. So, use the table only as a guide.



Using the self-timer

After you press the shutter button, the shutter will be released either about ten seconds or two seconds later. The 10-second self-timer is convenient when the photographer appears in a photo and the 2-second self-timer is convenient to reduce the camera-shake because the mirror is pulled up beforehand.

Check that the focus is confirmed on the subject, then press the shutter button.

(: The default setting)

	 (10s self-timer)	After you press the shutter button, the shutter will be released about 10 seconds later.
	 (2s self-timer)	After you press the shutter button, the shutter will be released about 2 seconds later.

- When using the 10-second self-timer, the self-timer lamp located on the front side flashes and lights up right before the shutter is released. The self-timer indicator located on the LCD monitor is highlighted. The countdown sound also starts.
- To cancel the activated 10-second self-timer, press the  /  (Drive) button. The self-timer is canceled when the power is turned off. You can also cancel it when the shooting is completed. You cannot cancel the 2-second self-timer in the middle.
- When there is bright lighting, a reflector or something similar behind the camera, and you press the shutter button without looking into the viewfinder, use the eyepiece cover attached on the shoulder strap to prevent unnecessary lighting from seeping through the viewfinder and affecting the exposure (page 41).



Shooting three images with the exposure shifted – Exposure Bracket

An accurate exposure setting is required for some shooting. In such cases, a photographer continuously shoots some images with the exposure shifted, aside from the correct exposure image. The camera shoots three images with the exposure shifted automatically.





Continuous bracket

(: The default setting)

	 (Bracket:0.3Ev cont.)	Shoots images continuously with the exposure value shifted by plus or minus 0.3 step. Press and hold the shutter button until the recording stops.
	 (Bracket:0.7Ev cont.)	Shoots images continuously with the exposure value shifted by plus or minus 0.7 step. Press and hold the shutter button until the recording stops.

Single bracket

(✓: The default setting)





✓	 (Bracket:0.3Ev single)	Shoots images frame by frame with the exposure value shifted by plus or minus 0.3 step. Press the shutter button frame by frame.
	 (Bracket:0.7Ev single)	Shoots images frame by frame with the exposure value shifted by plus or minus 0.7 step. Press the shutter button frame by frame.

- When using the flash, press the shutter button frame by frame regardless of the setting.
- The image is shot in the order of 0 (correct), - (under), and + (over). The order can be changed in [Bracket order] in the  Recording menu (page 87).
- The base exposure is set at the first frame in the bracket. The base exposure moves if exposure compensation is used.
- Normally, the focal point changes in every shooting. The focal point is fixed only in continuous bracket shooting when AF mode is set to [Single-shot AF] or [Automatic AF] with a still subject.
- When the flash is not used, ambient bracket shooting is performed and the shutter speed and aperture are changed to accommodate bracket shooting. When the flash is used, flash bracket shooting is performed and the flash light is changed.
- In ambient bracket shooting, the shutter speed and aperture change in program auto mode, the shutter speed changes in aperture priority mode, and aperture changes in shutter speed priority mode. Normally, the shutter speed changes in manual mode. You can change the aperture by pressing and holding the AEL (AE Lock) button while taking a picture.

Ambient light: Any light other than the flash light that shines on the scene for an extended period of time, such as natural light, a light bulb, or a fluorescent light.

The Ev scale in bracket shooting

When bracket shooting is selected, the Ev scale is changed

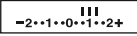
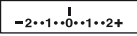
	Ambient bracket 0.3 steps Exposure compensation 0	Ambient bracket 0.3 steps Exposure compensation 1.0	Flash bracket 0.7 steps Flash compensation -1.0
LCD monitor			
	Shown in the top row.	Shown in the top row.	Shown in the bottom row.
Viewfinder			



- In ambient bracket shooting, the Ev scale appears in the viewfinder, too, but it does not appear in flash bracket shooting.
- When the bracket shooting starts, the indexes that indicate already recorded images start to disappear one by one.

- When Single bracket is selected, if the shutter button is pressed halfway down and released, “br 1” appears for the ambient light bracket and “Fbr 1” appears for the flash bracket in the viewfinder. When bracket shooting starts, it indicates what number the next frame is, for instance, “br 2”, “br 3”.

White balance bracket shooting

Based on the selected white balance, and color temperature/CC filter, three pictures are taken while automatically shifting the color temperature. One shot records three frames of an image in the order of “an image with normal white balance”, “- side (an image with paler colors)”, and “+ side (an image with reddish colors.)”

(: The default setting)

<input checked="" type="checkbox"/>	 (Bracket: WB (L))	Shifts the white balance by 10 mired* when taking a picture.
<input type="checkbox"/>	 (Bracket: WB (H))	Shifts the white balance by 20 mired* when taking a picture.

* Mired: a unit to indicate the color conversion quality in color temperature filters.

- Only the image recorded last is displayed in instant playback (page 84).

Adjusting the exposure

You can manually shift the exposure value determined by the camera. Use this mode when you do not get the proper exposure, for instance, the subject and its background have high contrast (light and dark).

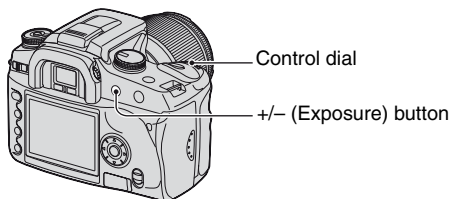

Press the +/- (Exposure) button and turn the control dial to adjust the exposure.



Toward -

Toward +

Toward +: Brightens an image.

0: The exposure is determined automatically by the camera.

Toward -: Darkens an image.

The compensation level is displayed in the Ev scale on the LCD monitor and in the viewfinder.

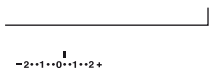
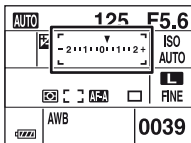

- For details on the exposure → page 16
- The exposure is compensated by 1/3 of a step between $\pm 2.0\text{EV}$.
- You can check the result of the exposure compensation using the histogram display (page 74).

💡 Shooting techniques

While shooting images, the camera automatically determines the exposure. When shooting a whitish overall image such as a backlit subject or a snowy scene, the camera judges that the subject is bright and may set a darker exposure for the image. In such cases, adjustment of the exposure in the + plus direction is effective.



Adjust in the + direction

When shooting a darker overall image, the camera judges that the subject is dark and may set a brighter exposure for the image. In such cases, adjustment of the exposure in the - minus direction is effective.



Adjust in the - direction

You can try to adjust the exposure to suit your taste.

Locking the exposure (AE lock)

You can fix the exposure before deciding on the composition when taking a picture. This is effective when the metering object and focusing object are different, or when you want to shoot continuously while keeping the same exposure value.

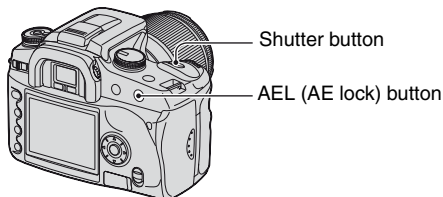

- ① Target the subject for which you want to meter the exposure.
 - Adjust the focus (you do not need to lock the focus.)
- ② Press the AEL (AE lock) button.
 - “AEL”* lights up in the viewfinder and on the LCD monitor to indicate that the exposure is locked.
 - * AEL: Stands for Auto Exposure Lock
- ③ While pressing the AEL (AE lock) button, recompose the image, if necessary, and press the shutter button to take the picture.
 - If the AEL (AE lock) button is kept down after a shot, you can continue to shoot with the same exposure value. The setting is canceled when the button is released.
 - When the flash is fired in a mode other than shutter speed priority mode or manual mode, slow sync control is activated and AE Lock is performed (page 69).
 - You can set the camera to keep the exposure value after releasing the AEL (AE lock) button (page 93).
 - Regardless of the type of metering mode selected, you can set the camera to temporarily fix the exposure using the spot metering (Spot AEL) by pressing the AEL (AE lock) button (page 93).

About the Ev scale when the AEL (AE lock) button is pressed

When you lock the exposure by pressing the AEL (AE lock) button, the locked exposure value is set as the standard (0). After recomposing, the Ev scale displays the metered light level within the spot metering circle. This tells you the difference in brightness among the segments of the screen.

- If the light level within the spot metering circle exceeds 2.0Ev more/less than the standard value, <D> appears at the end of the Ev scale. The <D> starts flashing if the difference becomes any greater.

Example: When the composition is determined in the scene below and the AEL (AE lock) button is pressed

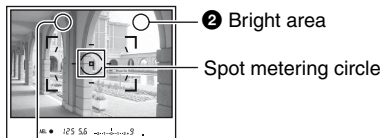



② Bright area

Spot metering circle

① Slightly darker area

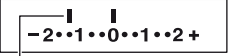
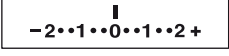
The indicator displays are as follows when the AEL (AE lock) button is pressed.

	AEL (AE lock) button is pressed	Recompose on ① while holding the AEL (AE lock) button down	Recompose on ② while holding the AEL (AE lock) button down
Multi-segment/Center metering	<p>The locked exposure</p>  <p>The light level within the spot metering circle is 0.3Ev less than the locked exposure (varies according to the recomposition of the shot)</p>	<p>Turn the camera on ① and the light level of ① is displayed. The locked exposure (0) stays the same.</p>  <p>The light level of ① is 1.3Ev less than the locked exposure (varies according to the recomposition of the shot)</p>	<p>Turn the camera on ② and the light level of ② is displayed. The arrow indicates ② will white out.</p>
Spot metering	 <p>The locked exposure is equal to the light level within the spot metering circle</p>	<p>Turn the camera on ① and the light level of ① is displayed. The locked exposure (0) stays the same.</p>  <p>The light level of ① is 1.0Ev less than the locked exposure (varies according to the recomposition of the shot)</p>	

Slow Sync (Shooting the dark background with flash)

When you shoot a portrait outdoors at night with a dark background, a normal use of flash will capture a clear image of the subject, but the background is out of flash range and will be too dark. In such a case, slow sync shooting (shooting with the flash and a slow shutter speed) allows you to capture a clear image of both the subject and the background.

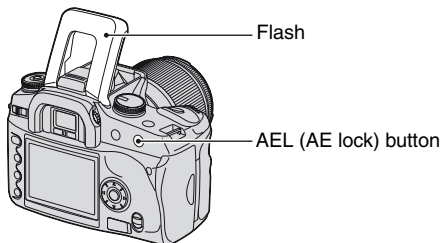

- ① Pull up the built-in flash.
 - ② Shoot with the AEL (AE lock) button pressed.
“AEL” in the viewfinder and on the LCD monitor lights up to indicate the exposure is locked.
- Use of a tripod is recommended because of the slower shutter speed.
 - When the flash is not used, you can fix the exposure by pressing the AEL (AE lock) button (page 67).
 - In shutter speed priority mode or manual mode, slow sync shooting is not available using the AEL (AE lock) button.
 - You can set the camera to keep the slow sync mode after the AEL (AE lock) button is released (page 93).

Depth-of-field preview

The viewfinder shows an image captured with the widest aperture. The change in aperture affects the sharpness of the subject image, creating a discrepancy between the sharpness seen in the viewfinder and in the actual picture. The preview function enables you to see the image with the aperture used in the actual shooting, allowing you to check the approximate sharpness of the subject image before the actual shooting.

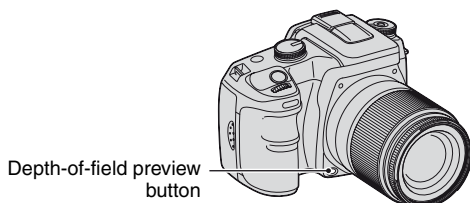

Press the depth-of-field preview button after the subject is in focus.

While the button is held down, the aperture is narrowed to match the aperture value displayed in the viewfinder.

- About aperture and blurred images, → aperture priority mode (page 34)
- The image in the viewfinder will be darker because the aperture is narrowed (aperture value is greater.)
- The aperture value can be changed during preview.
- When the focus is not fixed and the preview button is pressed, you cannot take a picture. To take a picture, press the depth-of-field preview button with ● lit in the viewfinder.
- With a lens equipped with a focus hold button, you can set the camera to perform the preview function using the focus hold button (page 93).

Focusing manually

When it is difficult to get the proper focus in auto focus mode, you can adjust the focus manually.

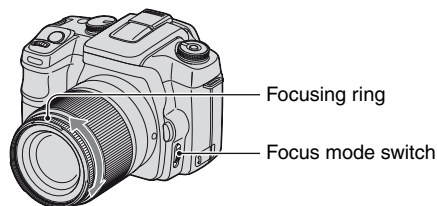

- ① Set the focus mode switch to MF*.
* MF: stands for Manual Focus.
 - ② Turn the focusing ring of the lens to achieve a sharp focus.
- In the case of a subject that can be focused in auto focus mode, the ● indicator lights up in the viewfinder when the focus is confirmed. When the wide focus frame is used, the center frame is used, and when the local focus frame is used, the frame that is selected with the controller is used.
 - To obtain steady exposure in manual focus mode, the camera uses the distance information to determine the exposure. To improve the precision of the distance information, the camera resets the focal length to ∞ (infinity) when the POWER switch is set to ON.

Switching the playback screen

During playback, each time you press the  (Display) button, the screen changes between the index screen and the single-image screen.

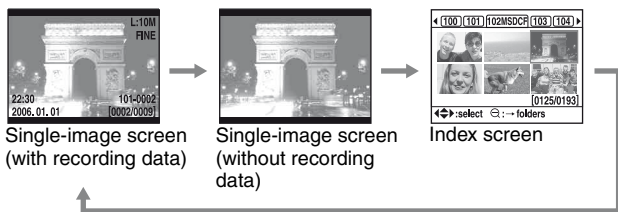
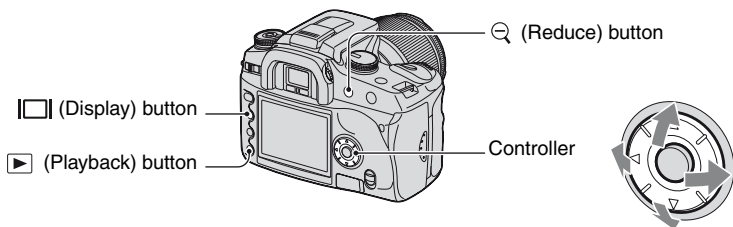

In index mode (File browser)

The folder containing the images now displayed

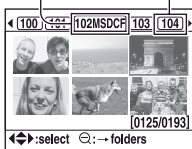

First three digits of the folder name (Folder number)



In each folder, six frames of image are displayed on the LCD monitor (File browser index). You can move frames around with /// on the controller. This is useful when you want to scan the images to find the one you want.



- You can display all the images other than by the folder. The images can be displayed four images at a time, nine images at a time, or 16 images at a time (page 90).

To select the folder

- ① Press  (Reduce) to highlight the folder name.
- ② Select the desired folder with / on the controller.
- ③ Press  (Reduce) to move to the images area and select the desired image with /// on the controller.

To delete all the images in the folder

You can delete all the images in the folder when the file browser index screen is displayed.

- ① Select the folder you want to delete with ◀▶ on the controller.
 - ② Press the  (Delete) button.
The message “Delete folder and its contents?” appears.
 - ③ Select “Yes” with ◀, then press the center of the controller.
The selected folder is deleted.
 - You can continue to delete folders.
 - You can set the confirmation screen to [Yes], as previously selected in the  Setup menu (page 103).
 - When you want to delete selected images, see page 88.
- It may take a long time to delete a lot of images. It is recommended that you delete images on a computer or format the recording medium using the camera.
 - Once you have deleted an image, you cannot restore it.
 - Protected images cannot be deleted.
 - If you delete the recording folder currently selected with [Select folder], select a recording folder again with [Select folder] in the  Setup menu (page 101).

Displaying the histogram

The histogram and recording data of the displayed image can be displayed.

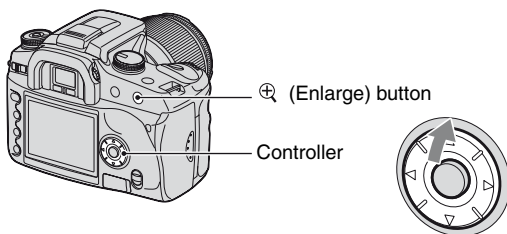

Press ▲ on the controller to display the histogram in single-image playback. Press ▲ on the controller again to return to single-image playback.

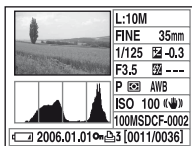

- You can select images with ◀▶.
- You can enlarge images with the (Enlarge) button.

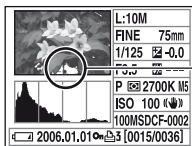

When the image has a high-key or low-key portion, that portion is illuminated on the histogram display (Luminance limit warning).

💡 About Histogram

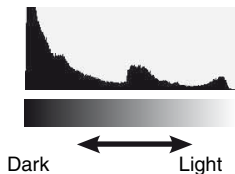

Number of pixels

A histogram is the luminance distribution that shows how many pixels of a particular brightness exist in the picture. The histogram display of this camera shows the brightness on the horizontal axis (left side is black, right side is white) and the number of pixels on the vertical axis. The exposure compensation will change the histogram accordingly. Below is an example.

For details on pixels → page 17.



Use the exposure compensation on the positive side.

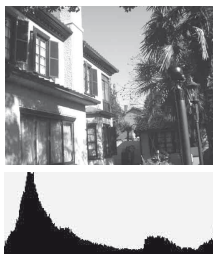

Shooting with the exposure compensation on the positive side brightens the whole picture, making the entire histogram shift to the bright side (right side). If the exposure compensation is used on the negative side, the histogram will shift to the other side.

Both ends of the histogram consist only of data of 100% black or white*. Therefore, when the data is transferred to a PC later in order to compensate it, it is impossible to restore the area that has been blacked/whitened out. Checking the histogram allows you to know the status of the image beforehand.

* To be exact, a color image is expressed with RGB. Thus, the white is equal to R255, G255, B255, and the black is equal to R0, G0, B0.

Rotating an image

You can rotate a playback image.

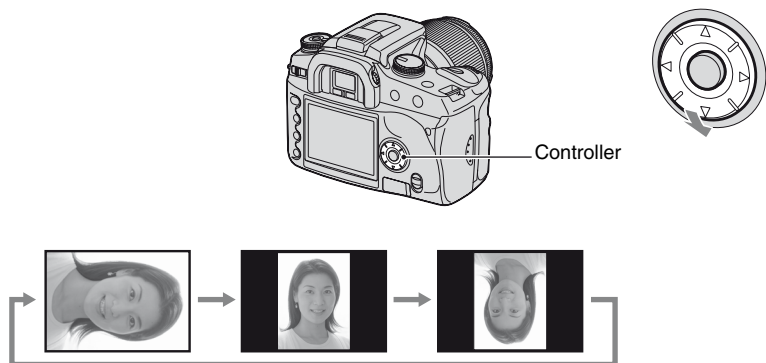

- ① Display the image you want to rotate in single-image playback.
 - ② Each time you press ▼ on the controller, the image is rotated as illustrated above.
- Once you rotate the image, the image rotation information is retained, even if you display other images or turn off the power. The image is played back in the rotated position next time.
 - When you copy rotated images to a computer, "Picture Motion Browser" (supplied) can display the rotated images correctly. However, the images may not be rotated depending on the software.
 - You can rotate an image when using a write-protected recording medium, however, the image will not be rotated on the next playback.

Enlarging images

An image can be enlarged for closer examination.

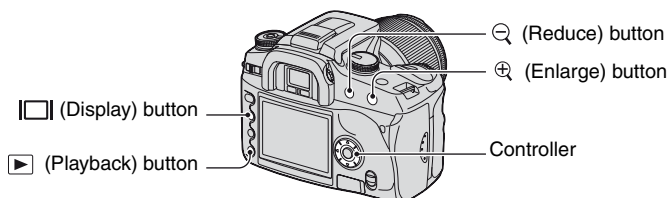

- 1 Press the (Enlarge) button in single-image (or index) playback mode. The center of the image is enlarged.

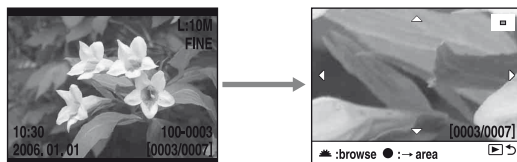

- You can scale up or down with the (Enlarge) button or the (Reduce) button.
- 2 Select the portion you want to enlarge with /// on the controller.
 - You can select the image with the control dial.
 - Each time you press the center of the controller, the screen changes between the enlarged screen and the whole screen.

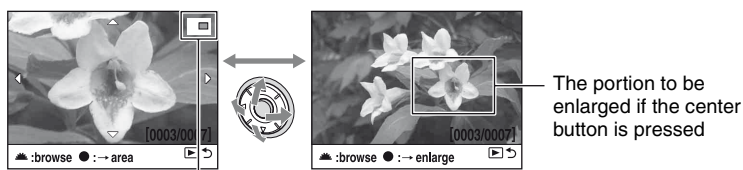

The map of the enlarged portion

- 3 Press the (Playback) button so that enlarged playback is canceled and the screen returns to single-image (or index) playback mode.

The scaling range is as follows. (The scale is not displayed)

Image size	Scaling range
L:10M	Approx. $\times 1.1 - \times 12$
M:5.6M	Approx. $\times 1.1 - \times 9$
S:2.5M	Approx. $\times 1.1 - \times 6$

- Pressing the (Display) button clears the indications on the screen during enlarged playback.

Viewing images on a TV screen

You can view images on a TV screen by connecting the camera to a TV.

Turn off both your camera and the TV before connecting the camera and the TV.

1 Connect the camera to the TV.

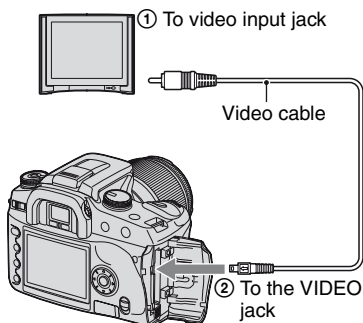



2 Turn on the TV and set the TV/ video input switch to “video.”

- For details, see the operating instructions supplied with the TV.

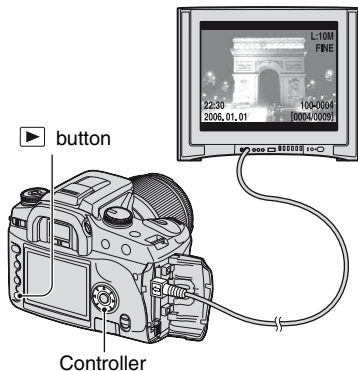
3 Turn on the camera, and press (Playback).



Images shot with the camera appear on the TV screen.

Press   on the controller to select the desired image.

- When using your camera abroad, it may be necessary to switch the video signal output to match that of your TV system (page 98).
- When you display the images recorded in Adobe RGB mode on the camera or sRGB devices, such as on TVs/LCD monitors that are not compatible with Adobe RGB (DCF2.0/Exif2.21), the images are displayed by lower intensity level.
- The LCD monitor on the rear of the camera does not turned on.
- The image quality displayed on a TV screen is a little deteriorated comparing to images displayed on a PC monitor.

On TV color systems

If you want to view images on a TV screen, you need a TV with a video input jack and the video cable. The color system of the TV must match that of your digital still camera. Check the following lists for the TV color system of the country or region where the camera is used.

NTSC system

Bahama Islands, Bolivia, Canada, Central America, Chile, Colombia, Ecuador, Jamaica, Japan, Korea, Mexico, Peru, Surinam, Taiwan, the Philippines, the U.S.A., Venezuela, etc.

PAL system

Australia, Austria, Belgium, China, Czech Republic, Denmark, Finland, Germany, Holland, Hong Kong, Hungary, Italy, Kuwait, Malaysia, New Zealand, Norway, Poland, Portugal, Singapore, Slovak Republic, Spain, Sweden, Switzerland, Thailand, United Kingdom, etc.

PAL-M system

Brazil

PAL-N system

Argentina, Paraguay, Uruguay

SECAM system

Bulgaria, France, Guiana, Iran, Iraq, Monaco, Russia, Ukraine, etc.

Using menu items

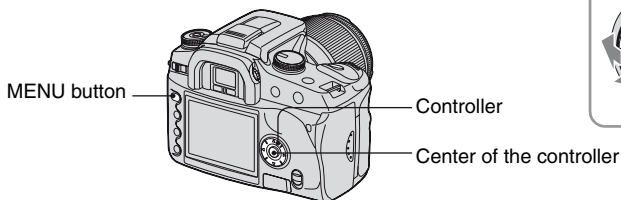

1 Turn on the power.

2 Press MENU to display the menu.

3 Select the desired menu with ◀/▶ on the controller, then press the center of the controller.

- 📷 Recording menu ⚙️ Custom menu
- ▶️ Playback menu ⚙️ Setup menu

- When the desired menu is already displayed (the menu icon is displayed on the extreme left), skip this step.

Menu now selected

Menus not selected

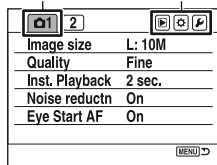

4 Select the page with ◀/▶ on the controller.

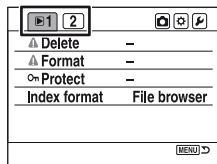

5 Select the desired item with ▲/▼ on the controller.

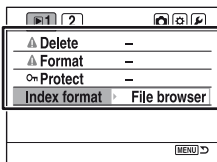

6 Display the options with ► on the controller.

- To return to the menu options, press ◀.

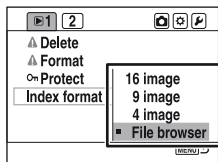

7 Select the desired option ▲/▼ on the controller, then press the center of the controller.

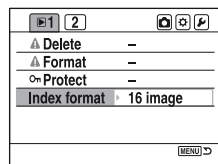



8 Press MENU to turn off the menu.





- The menu is also turned off if you press the shutter button halfway down.

- When setting the menu, you can substitute the control dial for ◀/► on the controller.
- During operation, if you press MENU, the setup is canceled and the camera returns to the recording (or playback) mode.
- When you display a menu, you can display the previously selected menu first (page 102).



Recording menu (pages 83 to 87)

 1	 2
Image size Quality Inst.Playback Noise reductn Eye-Start AF	Red eye Flash control Flash default Bracket order  Reset





Playback menu (pages 88 to 92)

 1	 2
Delete Format  Protect Index format	Slide show  DPOF set <ul style="list-style-type: none"> • Date imprint • Index print • Cancel print

Custom menu (pages 93 to 97)

 1	 2
Priority setup FocusHoldButt. AEL button Ctrl dial set Exp. comp. set AF illuminator	Shutter lock Shutter lock AF area setup Monitor Disp. Rec. display Play. display

Setup menu (pages 98 to 104)

 1	 2	 3
LCDbrightness Transfer mode Video output Audio signals  Language Date/Time set	File # memory <ul style="list-style-type: none"> • Reset Folder name Select folder <ul style="list-style-type: none"> • New folder 	LCD backlight Power save MenuSec.Memory Delete conf. Clean CCD Reset default



The default settings are marked with .

Image size

For details, see page 17.

	L:10M	3872 × 2592 pixels
	M:5.6M	2896 × 1936 pixels
	S:2.5M	1920 × 1280 pixels

- For details on the number of images that can be taken when the image size is changed, see page 27.
- When [Quality] is set to [RAW] or [RAW & JPEG], image size is fixed to [L:10M].

Quality

The image compression rate determines the image quality. As the file size (page 17) of the uncompressed image will be larger, it is common for a digital camera to compress the recorded image.

	RAW (RAW)	<p>File format: RAW (raw data)</p> <p>A RAW file is the raw material to be processed on the computer for professional purposes. The file can be opened with the “Image Data Converter SR” provided on the CD-ROM (supplied) (page 119).</p> <ul style="list-style-type: none"> • The image size is fixed to [L:10M]. The image size is not displayed on the LCD monitor.
	RAW & JPEG (RAW+)	<p>File format: RAW (raw data) + JPEG</p> <p>When the shutter button is pressed, a RAW image and a JPEG image are created at the same time. This is suitable when you need two image files, a JPEG for viewing, and a RAW for editing. The size of the JPEG image is fixed to [L:10M] and the image quality is fixed to [Fine].</p>
	Fine (FINE)	<p>File format: JPEG</p> <p>The image is compressed in the JPEG format when recorded. The higher the compression rate, the smaller the file size. This will allow more files to be recorded in one recording medium, but the image quality will be lower. Once the image quality is lowered, it cannot be restored on a computer afterwards. If you plan to process or edit the image file later, consider the image quality carefully when selecting the setting.</p>
	Standard (STD)	

- For details on the image quality → page 17
- For details on the number of images that can be taken when the image quality is changed, see page 27.

 About RAW files

The digital camera receives the image of the subject captured by the CCD (Charge-Coupled Device), which acts as the film for a normal camera. The RAW format file is the raw data recorded on the CCD yet to go through any kind of digital processing. A RAW file is different from a more common file format such as JPEG in that it is the raw material to be processed for professional purposes. You need the "Image Data Converter SR" software included on the CD-ROM (supplied) in order to open a RAW file recorded on this camera. With this software, a RAW file can be opened and converted to a common format, such as JPEG or TIFF, and its white balance, color saturation, contrast, etc., can be readjusted.



- Recording a RAW format image entails the following limitations.
 - The image size is fixed to the largest size (L:10M)
 - The RAW file cannot be printed using a DPOF (print) designated printer or a PictBridge compliant printer.
 - Unlike a JPEG image, a RAW image does not go through any basic image processing, so its colors cannot be accurately reproduced in playback mode or on an instant playback screen. If the data is correctly recorded, accurate colors can be reproduced on a computer.

Inst. Playback

After an image is recorded, you can display it on the LCD monitor for two, five, or 10 seconds. You can also delete it during instant playback.

	10 sec.	Displays the image on the LCD monitor for 10 seconds.
	5 sec.	Displays the image on the LCD monitor for five seconds.
✓	2 sec.	Displays the image on the LCD monitor for two seconds.
	Off	Does not display the image.

To delete the image during instant playback

Press  (Delete), then select [Yes] on the confirmation screen with  on the controller, then press the center of the controller.

- During instant playback, you can switch the recording information on and off (page 72), choose to display the histogram (page 74), or enlarge the image (page 77). If a local focus frame is selected when an image is enlarged, the image is enlarged centering around the selected frame.
- Instant playback of continuous shooting, continuous bracket, and white balance bracket shows only the image recorded last. If you delete the image following the process above, only the displayed image is deleted.
- In instant playback, the image will not be displayed in the vertical position even if you set [Play. display] to [Auto rotate] (page 97).

Noise reductn

Long exposure makes noise conspicuous. When the shutter speed is one second or slower, noise reduction is activated to reduce the grainy noise that is common in long exposures.

✓	On	When a long exposure of one second or longer takes place, the noise reduction process is performed for the duration that the shutter was open. While the noise reduction is being performed, the message “Processing...” appears on the LCD monitor. You cannot take the next picture until the process is over.
	Off	This mode does not perform noise reduction. This is suitable when timing of shooting takes precedence. However, this makes the noise more conspicuous. It is recommended that you activate the noise reduction if you use long exposure.

- Noise reduction is not performed on continuous shooting or continuous bracketing regardless of this setting.

Eye-Start AF

The focus is confirmed when you look into the viewfinder, and the shutter speed and aperture are adjusted automatically.

✓	On	Automatically adjusts the focus. • This mode uses up the battery charge faster than [Off].
	Off	Does not adjust the focus.

The default settings are marked with .

Red eye

Reduces the red-eye phenomenon by providing low-flash light a few times before shooting when using the flash.

	On	Reduces the red-eye phenomenon.
	Off	Does not use Red-Eye Reduction.

- Red-Eye reduction is available only with the built-in flash. (When using an external flash (not supplied), the red-eye phenomenon rarely occurs.)

Flash control

You can select the flash control mode to set the amount of flash light.

	ADI flash	A pre-flash is fired right before shooting, and the camera sets the amount of flash light by measuring the amount of reflected light from the pre-flash and the associated distance information.
	Pre-flash TTL	A pre-flash is fired right before shooting, and the camera sets the amount of flash light by measuring only the amount of reflected light from the pre-flash. The distance information is not used in the calculation.

ADI: stands for “Advanced Distance Integration”

P-TTL: stands for “Pre-flash, Through the lens”

- When the distance between the subject and the external flash (not supplied) cannot be determined, (wireless flash shooting using an external flash (not supplied), shooting with an off-camera flash using a cable, shooting with a macro twin flash or ring light, etc.) the camera automatically selects Pre-flash TTL mode.
- Select [Pre-flash TTL] in the following cases, as the camera cannot obtain accurate distance information with ADI flash.
 - A wide panel is attached to the HVL-F36AM flash.
 - A diffuser is attached to the surface of the flash.
 - A filter with an exposure factor, such as an ND filter, is used.
 - A close-up lens is used.
- ADI flash is only available in combination with the lens that is provided with a distance encoder. To determine the lens is equipped with a distance encoder, refer to the operating instructions supplied with the lens.

Flash default

When the mode dial is set to AUTO, P, or Scene Selection, the flash mode is set to autoflash (default setting) automatically. When the flash is pulled up, if you want to make sure the flash fires without fail, you can set it to Fill-flash. In either case, you can change the flash mode with the function dial and the Fn button.

✓	Autoflash	When the mode dial is set to AUTO, P, or Scene Selection, and the flash is pulled up, the flash fires automatically only when the flash is necessary.
	Fill-flash	When the mode dial is set to AUTO, P, or Scene Selection, and the flash is pulled up, the flash fires every time.

Bracket order

The order in bracket shooting (page 62) can be selected. The order is common to both ambient light bracket and flash light bracket.

- This does not apply to white balance bracket.

✓	0 → - → +	Use 0Ev in shooting the first picture which presents the best shooting opportunity. Example: 0Ev → -0.3Ev → +0.3Ev
	- → 0 → +	Ordered from low to high exposure. Example: -0.7Ev → 0Ev → +0.7Ev

Reset

You can reset the main functions of the recording mode.

- ① Select [Enter] in [ Reset].
The message “Reset recording mode?” appears on the LCD monitor.
 - ② Select [Yes] with ◀ on the controller, then press the center of the controller.
The main functions of the recording mode are reset.
- For details on the items to be reset, see “Reset default” (page 151).

The default settings are marked with .



Delete

You can delete unnecessary images.

	MarkedImages	Deletes only the selected images. Follow the procedure below.
	All images	Deletes all the images on the recording medium. Follow the procedure below.

- Once you have deleted an image, you cannot restore it.
- Protected images cannot be deleted.
- Use the  (Delete) button to quickly delete images frame by frame (→ step 6 in “Read This First”).
- You can delete all the images in the folder collectively (page 73).

To delete selected images

- ① Select [MarkedImages] in [Delete].
- ② Select the image you want to delete with /▶ on the controller, then press ▲.
A  mark appears on the selected image.



- To cancel a selection, press ▼.

- ③ To delete other images, repeat step ②.
- ④ Press the center of the controller.
The message “Delete marked images?” appears.
- ⑤ Select [Yes] with ◀ on the controller, then press the center of the controller.
The selected images are deleted, and the screen returns to the menu screen.

To delete all images

- ① Select [All images] in [Delete].
The message “Delete all images on card?” appears.
 - ② Select [Yes] with ◀ on the controller, then press the center of the controller.
All the images are deleted, and the screen returns to the menu screen.
- It may take a long time to delete a lot of images by selecting [All images]. It is recommended that you delete images on a computer or format the recording medium using the camera.

Format

Formats the recording medium.

- Note that formatting irrevocably erases all data on a recording medium, including protected images.

① Select [Enter] in [Format].

The message “All data will be deleted. Format?” appears.

② Select [Yes] with  on the controller, then press the center of the controller.

The format is completed.

- During the format, the access lamp lights up. Do not eject the recording medium while the lamp is lit.
- Formatting may take several minutes depending on the recording medium.
- Format the recording medium using the camera. If you format it on a computer, the recording medium may not be usable with the camera, depending on the format type used.



Protect

Protects images against accidental erasure.

	MarkedImages	Protects only the selected images. Follow the procedure below.
	All images	Protects all the images on the recording medium.
	Cancel all	Cancels the protection of all the images on the recording medium.

To protect selected images

① Select [MarkedImages] in [ Protect].

② Select the image you want to protect with /  on the controller, then press .

A  mark appears on the selected image.



- To cancel a selection, press .

③ To protect other images, repeat step ②.

④ Press the center of the controller.

The image is protected, and the screen returns to the menu screen.

Index format

You can select the index screen format from the following settings.

	16 image	Displays 16 images on the screen.
	9 image	Displays nine images on the screen.
	4 image	Displays four images on the screen.
✓	File browser	Displays six images on the screen from folder to folder.

16 images

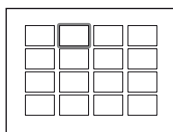

9 images

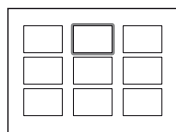

4 images

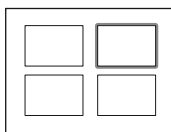

File browser

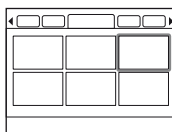

The default settings are marked with ✓.

Slide show

Plays back recorded images in order with a 5-second interval (Slide show).

Select [Enter] in [Slide show].

The slide show starts.

To end the slide show, press ▼ on the controller or MENU.

- During a slide show, you can display the previous/next image with ◀/▶.
- You can pause/play back the slide show with the center of the controller.
- You can switch the recording data on/off with the  (Display) button.



DPOF set

Using the camera, you can specify the images and the number of images to print before you print images at a shop or with your printer.



✓	MarkedImages	Prints only the selected images. Follow the procedure below.
	All on card	Prints all the images in the recording medium. Follow the procedure below.

- You cannot mark RAW data files.
- To print an image recorded in Adobe RGB with faithful color, the printer needs to be DCF2.0 option color space compliant.
- You can specify any number up to 9.







To mark selected images

- ① Select [MarkedImages] in [ DPOF set].
- ② Select the image you want to mark with ◀/▶ on the controller, then select the number of sheets with ▲/▼ (increases with ▲ and decreases with ▼).
A  (DPOF set) mark appears on the selected image, and the number of sheets is selected.



- To cancel a selection, press ▼ repeatedly to remove the  (DPOF set) mark.
- ③ To mark other images, repeat step ②.
 - ④ Press the center of the controller.
A  (DPOF set) mark appears on the selected image, and the screen returns to the menu screen.

To mark all the images

- ① Select [All on card] in [ DPOF set].
 - ② Select the number of sheets with / on the controller (increases with  and decreases with ). You cannot separately set the number of images.
 - ③ Press the center of the controller.
A  (DPOF set) mark appears on all the images, and the screen returns to the menu screen.
- When a DPOF-marked image is played back,  and its number are inserted onto the image.
 - If you insert a recording medium that contains DPOF-marked images specified with other cameras into this camera, then specify images to which to attach a DPOF-mark, the DPOF specifications made with other cameras are canceled.

Date imprint

You can impose the date onto images when printing images. The position of the date (inside or outside the image, character size, etc.) depends on your printer.

<input type="checkbox"/>	On	Imposes the date.
<input checked="" type="checkbox"/>	Off	Does not impose the date.

- Normally, only the date is inserted, however, imposed items may be different depending on the printer. This function may not be provided, depending on the printer.



Index print



You can create an index print of all the images in the folder (Index print). This camera can specify an index print, as well as frame by frame printing.

<input type="checkbox"/>	On	Specifies an index print.
<input checked="" type="checkbox"/>	Off	Does not specify an index print.

- The number of images to print on a sheet and the format depend on the printer. RAW images do not print in index print.
- The images you shot after setting the index print are not included in the index print. It is recommended that you create the index print just before printing it.

Cancel print

You can clear the  (DPOF) marks. When you do so, the index print is also canceled. Since the  (DPOF) marks are left on after printing, it is recommended that you just clear the marks.

- ① Select [Enter] in [Cancel print].
The message “Cancel all?” appears.
- ② Select [Yes] with  on the controller, then press the center of the controller.
The  (DPOF) marks of all the images are cleared.

The default settings are marked with ✓.

Priority setup

Select a setting for shutter release.

✓	AF	The shutter cannot be released when the focus is not confirmed.
	Release (RP*)	The shutter can be released even when the focus is not confirmed. Select this setting if the shooting opportunity takes precedence.

* RP: Stands for Release Priority.

- When [Release] is selected, “RP” appears on the recording information display. It is recommended that you shoot after confirming the focus in the viewfinder.

FocusHoldButt.

If you use a lens equipped with a focus hold button, you can change the function of the button to preview a shot.

✓	Focus hold	Use the button as the focus hold button.
	D.O.F.preview	Use the focus hold button as the depth-of-field preview button.

AEL button

The function and the mode of operation of the AEL (AE Lock) button can be changed. The AEL (AE Lock) button has two functions; an “AEL” function that locks the exposure value (shutter speed and aperture) in any metering mode, and a “ (Spot) AEL” function that temporarily performs spot metering and locks the acquired exposure value. The AEL button has two modes of operation; “hold” that functions only when the button is held down, and “toggle” that switches between activation and deactivation each time the button is pressed. Of these, the following combinations are available.

✓	AE hold	While the button is held down, the exposure value in the selected metering mode is locked. Press the shutter button to take a picture while keeping the AEL (AE Lock) button pressed down. This is suitable when the exposure needs to be maintained at the same level.
	AE toggle	Press the button once and release it, and the exposure value in the selected metering mode stays locked. Press the button again, and the lock is released. There is no need to hold the AEL (AE Lock) button down when the shutter button is pressed. This is suitable when the exposure needs to be maintained at the same level.

	<input type="checkbox"/> AE hold	While the button is held down, the camera temporarily performs spot metering regardless of the metering mode previously selected and locks the acquired exposure value. Press the shutter button to take a picture while keeping the AEL (AE Lock) button pressed down. This is suitable if you normally use multi-segment or center weighted metering but need to temporarily use spot metering because of the type of subject.
	<input type="checkbox"/> AE toggle	Press the button once and release it, and the camera temporarily performs spot metering regardless of the metering mode previously selected and locks the acquired exposure value. Press the button again, and the lock is released. There is no need to hold the AEL (AE Lock) button down when the shutter button is pressed. This is suitable if you normally use multi-segment or center weighted metering but need to temporarily use spot metering because of the type of subject.

- While the exposure value is locked, “AEL” appears on the LCD monitor and in the viewfinder. Be sure to remember to release the lock when “AE toggle” is selected.
- Except for the shutter speed priority mode and the manual mode, slow sync is selected and AE lock is performed when the flash is used (page 69).
- The “hold” and “toggle” settings affect the manual shift (page 39) in the manual mode.

Ctrl dial set

You can change the function of the control dial in manual and program shift mode.

<input checked="" type="checkbox"/>	Shutter speed	Manual Mode	Control dial: Shutter speed +/- (Exposure) button + Control dial: Aperture
		Program Shift	P _S shift (The control dial changes the shutter speed.)
	Aperture	Manual Mode	Control dial: Aperture +/- (Exposure) button + Control dial: Shutter speed
		Program Shift	P _A shift (The control dial changes the aperture.)

Exp. comp. set

In the default setting, if exposure compensation is selected when the flash is used, shutter speed, aperture, ISO sensitivity (only in AUTO mode), and amount of flash light all change in order to perform exposure compensation (page 65). By fixing the amount of flash light, you can limit the effect of exposure compensation to the background that is illuminated only by ambient light (light other than the flash.)

✓	Ambient&flash	Exposure compensation is performed on both the ambient light range (the background that the flash light does not reach) and the flash light range. <ul style="list-style-type: none"> • Values that change: shutter speed, aperture, ISO (only in AUTO mode), amount of flash light • Values that do not change: none
	Ambient only	The exposure compensation is limited to the ambient light range (the background), while the exposure of the flash light range is fixed. <ul style="list-style-type: none"> • Values that change: shutter speed, aperture, ISO (only in AUTO mode) • Values that do not change: amount of flash light

- With the flash compensation, you can limit the compensation to flash light range by fixing the exposure of ambient light range that the flash light does not reach (page 57).

Values that change: amount of flash light

Values that do not change: shutter speed, aperture, ISO

AF illuminator

When you press the shutter button halfway down using the flash under dark lighting, the flash light may be fired. This is AF fill light to help easily focus a subject in auto focus mode. You can set the AF illuminator to on or off.

✓	On	Fills the AF illuminator.
	Off	Does not fill the AF illuminator.

- When AF illuminator is set to [Off], the AF illuminator of an external flash (not supplied) is not triggered.

The default settings are marked with ✓.

Shutter lock

You can set the shutter lock to keep the shutter from releasing when no recording medium is inserted in the camera.

	On: no card	The shutter cannot be released when no recording medium is inserted in the camera.
✓	Off: no card	The shutter can be released when no recording medium is inserted in the camera.

Shutter lock

You can set the shutter lock to keep the shutter from releasing when no lens is mounted on the camera. When attaching the camera to an astronomical telescope, for example, select [Off: no lens] so the shutter can be released.

✓	On: no lens	The shutter cannot be released when no lens is mounted on the camera.
	Off: no lens	The shutter can be released when no lens is mounted on the camera.

AF area setup

When the shutter button is pressed halfway down, the local focus frame in focus is briefly illuminated in red. You can change the duration of illumination or turn off the illumination.

	0.6s. display	The local focus frame is illuminated for 0.6 seconds.
✓	0.3s. display	The local focus frame is illuminated for 0.3 seconds.
	Display off	No illumination.

- When [Display off] is selected, the local focus frame is illuminated only when the controller or the spot AF button is pressed.

Monitor Disp.

The eyepiece sensors located right below the viewfinder determines whether the photographer is looking into the viewfinder or not. The LCD monitor can be set to turn off automatically when you are looking into the viewfinder.

<input checked="" type="checkbox"/>	Automatic	The LCD monitor turns off automatically when you look into the viewfinder.
<input type="checkbox"/>	Manual	The LCD monitor stays on when you look into the viewfinder.

- Regardless of the setting in this menu, the recording information display automatically turns off after a set duration (five seconds in the default setting (page 102)).

Rec. display

You can set the recording information display to rotate automatically when the camera is in a vertical position.

<input checked="" type="checkbox"/>	Auto rotate	The display rotates automatically to a vertical position when the camera is in a vertical position.
<input type="checkbox"/>	Horizontal	The display does not rotate when the camera is in a vertical position.

Play. display

The image orientation can be recorded with the image which allows images recorded in a vertical position to be automatically displayed in the vertical position.

<input checked="" type="checkbox"/>	Auto rotate	The image orientation is recorded with the image.
<input type="checkbox"/>	Man. rotate	The image orientation is not recorded with the image.



- When [Auto rotate] is selected, an image loaded on a computer will be displayed in the vertical position with "Picture Motion Browser"/"Image Data Converter SR" (supplied). The image may not be displayed in a vertical position, depending on the software employed.
- To rotate the displayed image manually, see page 76.

The default settings are marked with .

LCDbrightness

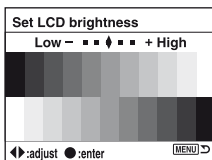
You can adjust the brightness of the LCD monitor.



- ① Select [Enter] in [LCDbrightness].
- ② Adjust the brightness with /  on the controller or with the control dial, then press the center of the controller.

Transfer mode

Selects the USB mode to be used when connecting the camera to a computer, etc., using a USB cable.

	Mass Storage	Used for copying images to the computer. The camera is recognized as a USB mass storage device.
	PTP	Prints the images with a PictBridge compliant printer or copies images to PTP (Picture Transfer Protocol) compliant devices. <ul style="list-style-type: none">• For details on printing with a PictBridge compliant printer, see page 123.

Video output

Sets the video signal output according to the TV color system of the connected video equipment. Different countries and regions use different TV color systems. If you want to view images on a TV screen, check page 79 for the TV color system of the country or region where the camera is used.

NTSC	Sets the video output signal to NTSC mode (e.g., for the USA, Japan).
PAL	Sets the video output signal to PAL mode (e.g., for Europe).

Audio signals

Selects the sound produced when the shutter is locked, during self-timer countdown, etc.

✓	On	Turns on the sound.
	Off	Turns off the sound.

 Language

Select the language to be used to display the menu items, warning, and messages.

- ① Select [ Language], then press ► on the controller.
- ② Select the desired language with ▲/▼ on the controller, then press the center of the controller.

Date/Time set

Sets the date and time.

Select [Enter] in [Date/Time set]. Then, perform the procedure explained in “Set the clock” (→ step 3 in “Read This First”).

The default settings are marked with .

File # memory

Selects the method used to assign file numbers to images.

<input checked="" type="checkbox"/>	On	Assigns numbers to files in sequence even if the recording folder or the recording medium is changed, or all of the images are deleted.
<input type="checkbox"/>	Off	Starts from 0001 each time the folder is changed or each time a recording date changes when using a date form folder. When the recording folder contains a file, a number one higher than the largest number is assigned.

Reset

Resets the file number. The number returns to “0001”. When the recording folder contains a file, a number one higher than the largest number is assigned.

Select [Enter] in [Reset].

Folder name



The default standard form folder (100MSDCF, etc.) can be changed to a date form folder to classify the folders by date for storage and playback.

<input checked="" type="checkbox"/>	Std. form	Selects the standard form folder.
<input type="checkbox"/>	Date form	Selects the date form folder. A new folder will be created automatically every time a recording date changes.

- The folders and images saved in the standard form folder will retain their names.
- If the [Date form] is selected, the folder name will be displayed as follows.

Example:

1	0	1	6	0	1	0	1
---	---	---	---	---	---	---	---

: Folder number

: Y (the last digit) / MM / DD

Select folder

When a standard form folder is selected and there are two or more folders, you can select the recording folder to be used to record images.

- ① Select [Select folder], then press ► on the controller.
 - ② Select the desired folder with ▲/▼ on the controller, then press the center of the controller.
- You cannot select the folder when you are setting [Date form].

New folder

Creates a folder in a recording medium for recording images.

A new folder is created with a number incremented one higher than the largest number currently used, and the folder becomes the current recording folder.

The default settings are marked with .

LCD backlight

During shooting, the recording information display appears on the LCD monitor. You can change the displayed time of the display.

	1 min.	Displays for one minute.
	30 sec.	Displays for 30 seconds.
	10 sec.	Displays for 10 seconds.
	5 sec.	Displays for five seconds.

- The display appears again if you press the shutter button halfway down or perform some other operation.



Power save



If you do not operate the camera for given period of time, the camera turns to power saving mode and almost completely shuts down (Power Save). → *step 3 in "Read This First"*
You can set the time to turn the camera to the power save mode.

	30 min.	The camera turns to power save mode after 30 minutes.
	10 min.	The camera turns to power save mode after 10 minutes.
	5 min.	The camera turns to power save mode after five minutes.
	3 min.	The camera turns to power save mode after three minutes.
	1 min.	The camera turns to power save mode after one minute.

- Pressing the shutter button returns the camera to the recording mode.

MenuSec.Memory

In the default setting, when you press the MENU button, the  1 or  1 menu screen is displayed first. You can change this setting to display the previously selected menu screen first.

	Off	Displays the  1 or  1 menu screen first.
	On	Displays the previously selected menu screen first.

Delete conf.

Before deleting images or folders, a confirmation screen, such as “Delete this image?”, appears. Normally, [No] is selected by default, but you can set this default option so that [Yes] is selected.

	“Yes”	[Yes] is selected by default.
✓	“No”	[No] is selected by default.

- This setting applies to both deleting images and folders.

Clean CCD

If dust or debris enters the camera and lands on the CCD (the part that acts as the film), it may appear on the photo image, depending on the shooting environment. If there is dust on the CCD, use a commercially available blower brush and clean the CCD following the steps below. You can easily brush the dust away using only the blower brush and the anti-dust function.

- **Cleaning can be performed only when the battery level is . Low battery power during cleaning can cause damage to the shutter. The cleaning should be completed quickly.**

- ① Confirm that the battery is fully charged.
 - The use of an AC Adaptor/charger (not supplied) is recommended.
- ② Select [Clean CCD], then select [Enter].
The message “After cleaning the CCD, turn camera off. Continue?” appears.
- ③ Select [Yes] with  on the controller, and press the center of the controller.
 - After the CCD vibrates for a short time, the mirror in front is lifted.
- ④ Detach the lens.
- ⑤ Use the blower brush to clean the CCD surface and the surrounding area.

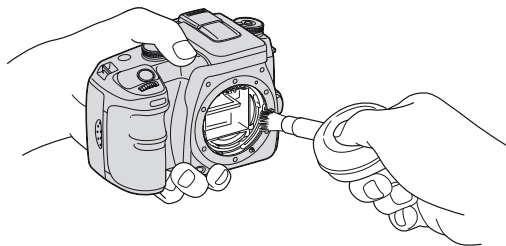

- Do not touch the CCD with the tip of the brush. Complete the cleaning quickly.
- Hold the camera's face downward to prevent the dust from resettling in the camera.
- Do not use a spray blower because it may scatter vapor inside the camera body.

- **When cleaning the CCD, do not put the tip of a blower brush into the cavity beyond the lens mount. You do not need to put the blower brush close to the CCD.**

⑥ Attach the lens and set the POWER switch to OFF.

- The camera starts beeping if the battery pack becomes low during cleaning. Stop the cleaning immediately and set the POWER switch to OFF.

 To keep dust from entering the camera

While it is impossible to completely shut out dust, the following reminders should help lower the possibility.

- Choose a location with little dust to change the lens, and complete the operation quickly.
- Do not leave the camera without a lens or the body cap.
- When attaching the body cap, remove all the dust from the cap before placing it on the camera.

Reset default

You can reset the main functions of the camera.

① Select [Enter] in [Reset default].

The message “Reset default?” appears.

② Select [Yes] with ◀ on the controller, then press the center of the controller.

The main functions are reset.

- For details on the items to be reset, see “Reset default” (page 151).

Enjoying your Windows computer

For details on using a Macintosh computer, refer to “Using your Macintosh computer” (page 120).

This section describes the English version screen contents.



Connecting the camera with your computer (page 107)

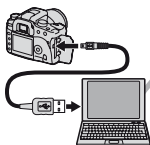

Preparing the camera and the computer, and connecting the camera and your computer

Copying images to your computer (page 108)



Viewing images on your computer

Enjoying images using the α 100 Application Software (page 114)



- Viewing images saved on your computer
- Viewing photos organized by date
- Editing images



Printing images

Recommended computer environment

The following environment is recommended for a computer connected to the camera.

Recommended environment for copying images

OS (pre-installed): Microsoft Windows 2000 Professional, Windows Millennium Edition, Windows XP Home Edition or Windows XP Professional

- Operation is not assured in an environment based on an upgrade of the operating systems described above or in a multi-boot environment.

USB jack: Provided as standard

Recommended environment for using “Picture Motion Browser”

OS (pre-installed): Microsoft Windows 2000 Professional, Windows Millennium Edition, Windows XP Home Edition or Windows XP Professional

CPU/Memory: Pentium III 500 MHz or faster, 128 MB of RAM or more (Recommended: Pentium III 800 MHz or faster and 256 MB of RAM or more)

Software: DirectX 9.0c or later

Hard Disk: Disk space required for installation—200 MB or more

Display:

800 × 600 dots or more, High Color (16-bit color) or more

- This software is compatible with DirectX technology. “DirectX” must be installed for use.

Recommended environment for using “Image Data Converter SR Ver.1.1”

OS (pre-installed): Microsoft Windows 2000 Professional, Windows XP Home Edition, or Windows XP Professional

CPU: MMX Pentium III 1 GHz or faster is recommended

Memory: 256 MB or more (512 MB or more is recommended.)

Virtual memory: 700 MB or more

Display: 1024 × 768 dots or more, High Color (16-bit color) or more

Notes on connecting your camera to a computer

- Operations are not guaranteed for all the recommended computer environments mentioned above.
- If you connect two or more USB devices to a single computer at the same time, some devices, including your camera, may not operate, depending on the types of USB devices you are using.
- Operations are not guaranteed when using a USB hub.
- Connecting your camera using a USB interface that is compatible with Hi-Speed USB (USB 2.0 compliant) allows advanced transfer (high speed transfer) as this camera is compatible with Hi-Speed USB (USB 2.0 compliant).
- Check that [Transfer mode] in the  Setup menu is set to [Mass Storage]. If it is set to [PTP], the camera is not recognized.
- When your computer resumes from a suspend or sleep mode, communication between your camera and your computer may not recover at the same time.

Copying images to your computer

This section describes the process using a Windows computer as an example. You can copy images from the camera to your computer as follows.

For directly inserting the recording medium in a computer

Remove the recording medium from the camera and insert it in the computer and copy the images.

For connecting the camera with the recording medium inserted to a computer using the USB connection

Follow Stages 1 through 4 on pages 107 to 111 to copy images.

- Check that [Transfer mode] in the  Setup menu is set to [Mass Storage] (page 98).

Stage 1: Preparing the camera and the computer

1 Insert a recording medium with recorded images into the camera.

2 Insert the sufficiently charged battery pack in the camera, or connect the camera to a wall outlet (wall socket) with the AC Adaptor/charger (not supplied).

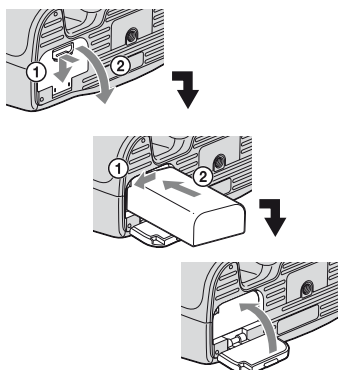

- When you copy images to your computer using insufficient battery pack, copying may fail or image data may become corrupted if the battery pack shut down too soon.

3 Turn on the camera and the computer.

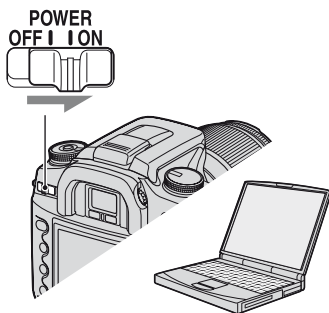

Stage 2: Connecting the camera and your computer

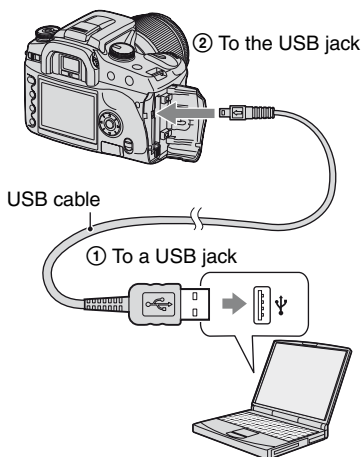

- With Windows XP, the AutoPlay wizard appears on the desktop.

Stage 3-A: Copying images to a computer

XP

- For Windows 2000/Me, follow the procedure explained in “Stage 3-B: Copying images to a Computer” on page 109.
- For Windows XP, when the wizard screen does not appear automatically, follow the procedure explained in “Stage 3-B: Copying images to a Computer” on page 109.

This section describes an example of copying images to a “My Documents” folder.

If the screen does not appear, press the shutter button on the camera halfway down.

- 1** After making a USB connection in Stage 2, click [Copy pictures to a folder on my computer using Microsoft Scanner and Camera Wizard] → [OK] as the wizard screen appears automatically on the desktop.

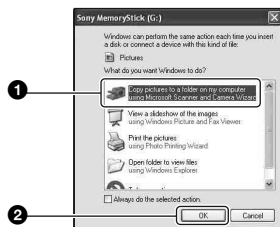

The “Scanner and Camera Wizard” screen appears.

- 2** Click [Next].

The images saved on the recording medium of the camera appear.

- When the software (supplied) has been installed, the [Import Images] screen may be displayed (page 115). In that case, you can also import images using “Picture Motion Browser”.

- 3** Click the check box of unwanted images to remove the checkmark so they are not copied, then click [Next].



The “Picture Name and Destination” screen appears.

- 4** Select a name and destination for the images, then click [Next].

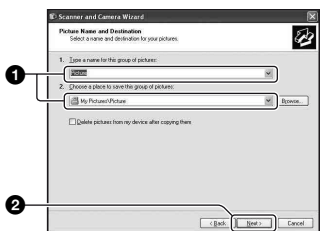
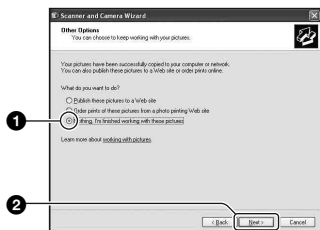

Image copying starts. When the copying is completed, the “Other Options” screen appears.

- This section describes an example of copying images to the “My Documents” folder.

- 5** Click the radio button next to [Nothing. I'm finished working with these pictures] to select it, then click [Next].



The “Completing the Scanner and Camera Wizard” screen appears.

- 6** Click [Finish].

The wizard screen closes.

- To continue copying other images, disconnect the USB cable (page 111). Then follow the procedure explained in “Stage 2: Connecting the camera and your computer” on page 108.

- RAW images cannot be displayed by this method. Select [Open folder to view files] in step 1, then open the [DCIM] folder following the process described in Stage 3-B, below and copy the images.

Stage 3-B: Copying images to a Computer

2000 Me

- For Windows XP, follow the procedure explained in “Stage 3-A: Copying images to a computer” on page 108.

This section describes an example of copying images to the “My Documents” folder.

If the screen does not appear, press the shutter button on the camera halfway down.

- 1 Double-click [My Computer] → [Removable Disk] → [DCIM].

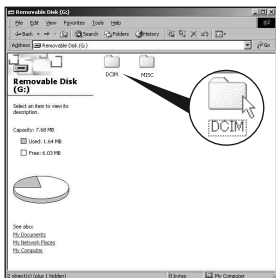

- 2 Double-click the folder where the image files you want to copy are stored.

Then, right-click an image file to display the menu and click [Copy].

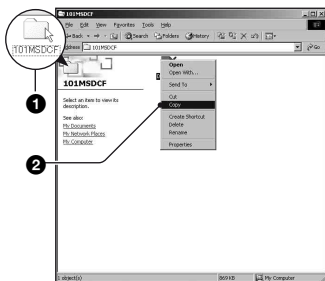

- On the storage destination of the image files, see page 112.

- 3 Double-click the [My Documents] folder. Then, right-click on the "My Documents" window to display the menu and click [Paste].

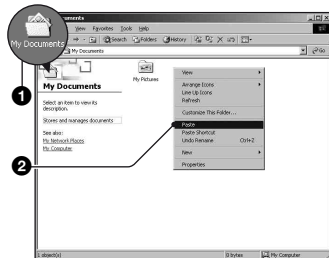

The image files are copied to the "My Documents" folder.

- When an image with the same file name exists in the copy destination folder, the overwrite confirmation message appears. When you overwrite an existing image with a new one, the original file data is deleted. To copy an image file to the computer without overwriting, change the file name to a different name and then copy the image file. However, note that if you change the file name (page 113), you may not be able to play back that image with your camera.

Stage 4: Viewing images on your computer

This section describes the procedure for viewing copied images in the “My Documents” folder.

1 Click [Start] → [My Documents].

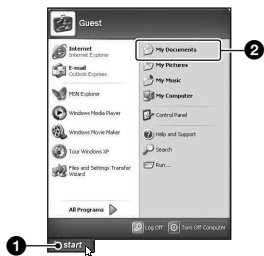

The contents of the “My Documents” folder are displayed.

- If you are not using Windows XP, double-click [My Documents] on the desktop.

2 Double-click the desired image file.

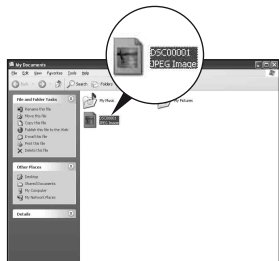

The image is displayed.

To delete the USB connection

Perform the procedures listed below beforehand when:

- Disconnecting the USB cable
- Removing a recording medium
- Turning off the camera

■ For Windows 2000/Me/XP

- ① Double-click  on the tasktray.



Double-click here

- ② Click  (USB Mass Storage Device) → [Stop].
 - ③ Confirm the device on the confirmation window, then click [OK].
 - ④ Click [OK].
The device is disconnected.
- Step 4 is unnecessary for Windows XP.

Image file storage destinations and file names

The image files recorded with your camera are grouped as folders on the recording medium.

Example: viewing folders on Windows XP

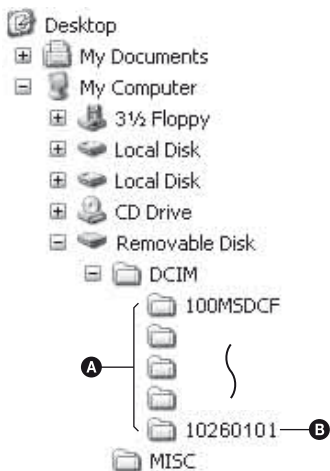

- A** Folders containing image data recorded using this camera. (The first three digits show the folder number.)
- B** You can create a folder by date form (page 100).

- You cannot record/play back any images to the “MISC” folder.
- If you delete folder except the latest folder in file browser index screen, the folder number becomes an unused number.
- Image files are named as follows. □□□□ (file number) stands for any number within the range from 0001 to 9999. The numerical portions of the name of a RAW data file and its corresponding JPEG image file are the same.
 - JPEG files: DSC0□□□□.JPG
 - JPEG files (Adobe RGB):
_DSC□□□□.JPG
 - RAW data file (other than Adobe RGB):
DSC0□□□□.ARW

– RAW data file (Adobe RGB):
_DSC□□□□.ARW

- The extension may not be displayed depending on the computer.
- For more information about folders, see pages 100, 101.

Viewing image files stored on a computer with your camera

This section describes the process using a Windows computer as an example.

When an image file copied to a computer no longer remains on a recording medium, you can view that image again on the camera by copying the image file on the computer to a recording medium.

- Step 1 is not necessary if the file name set with your camera has not been changed.
- You may be unable to play back some images depending on the image size.
- When an image file has been processed by a computer or when the image file was recorded using a model other than that of your camera, playback on your camera is not guaranteed.
- When there is no folder, first create a folder with your camera (page 101) and then copy the image file.

1 Right-click the image file, then click [Rename]. Change the file name to "DSC0□□□□."

Enter a number from 0001 to 9999 for □□□□.

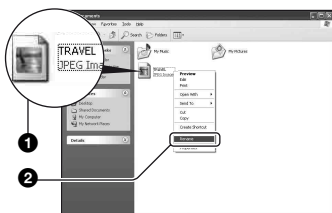

- If the overwrite confirmation message appears, enter a different number.
- An extension may be displayed depending on the computer settings. The extension for images is JPG. Do not change the extension.

2 Copy the image file to the recording medium folder in the following order.

- ① Right-click the image file, then click [Copy].
- ② Double-click [Removable Disk] or [Sony MemoryStick] in [My Computer].
- ③ Right-click the [□□□MSDCF] folder in the [DCIM] folder, then click [Paste].
 - □□□ stands for any number within the range from 100 to 999.

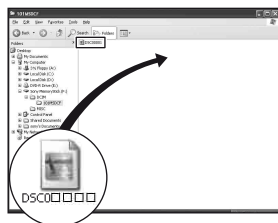

Installing the software (supplied)



You can install the software (supplied) using the following procedure.

- In Windows 2000/XP, log on as Administrator.
- “Picture Motion Browser” and “Image Data Converter SR Ver. 1.1” are installed at the same time.

1 Turn on your computer, and insert the CD-ROM (supplied) into the CD-ROM drive.

The installation menu screen appears.



- If it does not appear, double-click  (My Computer) →  (SONYPICUTIL).

2 Click [Install].

The “Choose Setup Language” screen appears.

3 Select the desired language, then click [Next].

The “License Agreement” screen appears.

Read the agreement carefully. If you accept the terms of the agreement, click the radio button next to [I accept the terms of the license agreement] and then click [Next].

4 Follow the instructions on the screen to complete the installation.

“Image Data Converter SR Ver.1.1” is also installed.

- When the restarting confirmation message appears, restart the computer following the instructions on the screen.
- DirectX is also installed depending on your computer environment.
- In Windows Me, “Image Data Converter SR Ver. 1.1” is not installed.

5 Remove the CD-ROM after the installation is complete.

After you install the software, a shortcut icon for the customers registration website is created on the desktop.

Once you register on the website, you can get secure and useful customer support.
<http://www.sony.net/registration/di/>

Using the software (supplied)

You can use images from the camera more than ever by taking advantage of the software.

This section summarizes the “Picture Motion Browser” and “Image Data Converter SR Ver. 1.1” and gives basic instructions.

“Picture Motion Browser” overview

With the “Picture Motion Browser” you can:

- Import images shot with the camera and display them on the monitor.
- Organize images on the computer on a calendar by shooting date to view them.
- Retouch, print, and send images as e-mail attachments, change the shooting date, and more.
- For details, refer to the Help.

To access the Help, click [Start] → [All Programs] (in Windows 2000/Me, [Programs]) → [Sony Picture Utility] → [Help] → [Picture Motion Browser].

Starting and exiting the “Picture Motion Browser”

Starting the “Picture Motion Browser”

Double-click the  (Picture Motion Browser) icon on the desktop.

Or, from the Start menu: Click [Start] → [All Programs] (in Windows 2000/Me, [Programs]) → [Sony Picture Utility] → [Picture Motion Browser].

Exiting the “Picture Motion Browser”

Click  button in the top right corner of the screen.

Basic instructions

Follow these steps to import and view images from the camera.

Importing images

1 Make sure “Media Check Tool”* is running.

* “Media Check Tool” is a program that automatically detects and imports images when a recording medium is inserted or when the camera is connected.

Look for a  (Media Check Tool) icon in the taskbar.

- If there is no  icon: Click [Start] → [All Programs] (in Windows 2000/Me, [Programs]) → [Sony Picture Utility] → [Tools] → [Media Check Tool].

2 Connect the camera to your computer with the USB cable.

After the camera is automatically detected, the [Import Images] screen is displayed.

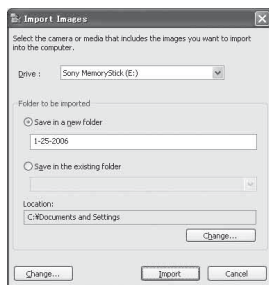

- If you will insert a recording medium directly into a computer, first refer to page 107.
- In Windows XP, if the AutoPlay Wizard appears, close it.

3 Import the images.

To start importing images, click the [Import] button.

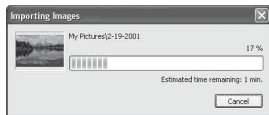

By default, images are imported into a folder created in “My Pictures” that is named with the date of importing.

- For instructions on changing the “Folder to be imported”, refer to page 118.

Viewing images

1 Checking imported images

When importing is complete, the “Picture Motion Browser” starts. Thumbnails of the imported images are displayed.

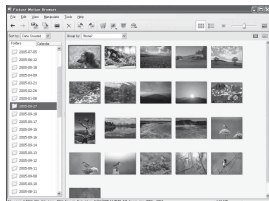

- The “My Pictures” folder is set as the default folder in “Viewed folders”.
- You can double-click a thumbnail to display the image by itself.

2 Viewing images in “Viewed folders” arranged by shooting date on a calendar

- ① Click the [Calendar] tab.
Years when images were shot are listed.
- ② Click the year.
Images shot that year are displayed, arranged on the calendar by shooting date.
- ③ To display images by month, click the desired month.
Thumbnails of images shot that month are displayed.
- ④ To display images by time, click the desired date.
Thumbnails of images shot that day are displayed, arranged by hour.

Year display screen

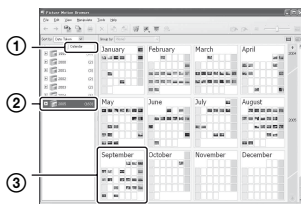

Month display screen

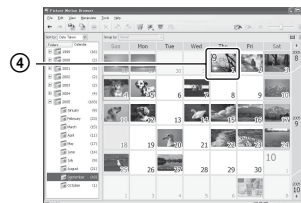

Hour display screen

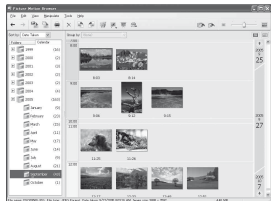

- To list images from a particular year or month, click that period on the left of the screen.

3 Displaying individual images

On the hour display screen, double-click a thumbnail to display the image by itself in a separate window.





- You can edit displayed images by clicking the  toolbar button.

Displaying images in full-screen mode

To display a slide show of current images in full-screen mode, click the  button.



- To play or pause the slide show, click the  button on the lower left of the screen.
 - To stop the slide show, click the  button on the lower left of the screen.
-

Other functions

Preparing images stored on the computer for viewing

To view them, register the folder that contains the images as one of the “Viewed folders”.

- 1 Click  on the main screen, or choose [Register Folders to View] from the [File] menu.

The settings screen for “Viewed folders” registration is displayed.

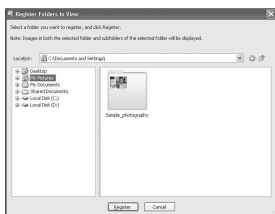

- 2 Specify the folder with images for importing to register the folder as one of the “Viewed folders”.

- 3 Click [OK].

The image information is registered in the database.

- Images in any subfolders of “Viewed folders” are also registered.

Changing the “Folder to be imported”

To change the “Folder to be imported”, access the “Import Settings” screen.

- 1 Choose [Import Settings] → [Location for Imported Images] from the [File] menu.

The “Location for Imported Images” screen is displayed.



- 2 Choose the “Folder to be imported”.

- You can specify the “Folder to be imported” from folders registered as “Viewed folders.”

Updating image registration information

To update image information, choose [Update Database] from the [Tools] menu.

- Updating the database may take a while.
- If you rename image files or folders in “Viewed folders”, they cannot be displayed with this software. In this case, update the database.

To uninstall the “Picture Motion Browser”

- ① Click [Start] → [Control Panel] (For Windows 2000/Me: [Start] → [Settings] → [Control Panel]), then double-click [Add/Remove Programs].
- ② Select [Sony Picture Utility], then click [Remove] (For Windows 2000/Me: [Change/Remove]) to execute the uninstallation.

Overview of “Image Data Converter SR Ver. 1.1”

Using “Image Data Converter SR Ver. 1.1” stored on the CD-ROM (supplied), you can edit images recorded in RAW mode with various corrections, such as tone curve, and sharpness. Also, you can save the images in a general-purpose file format.

- If you save the ARW format data as the RAW format, the data is converted to the SR2 format.
- For details, refer to the Help.

Starting up or exiting “Image Data Converter SR Ver. 1.1”

To start up

Click the shortcut of “Image Data Converter SR Ver. 1.1” on the desktop.
When starting up from the Start menu, click [Start] → [All Programs] (For Windows 2000: [Program]) → [Sony Picture Utility] → [Image Data Converter SR].

To exit

Click the  button on the upper-right of the screen.

Technical Support

Additional information on this product and answers to frequently asked questions can be found at the Sony Customer Support Website.
<http://www.sony.net/>

Using your Macintosh computer

You can copy images to your computer or edit a RAW data file using “Image Data Converter SR Ver.1.1”.

- “Picture Motion Browser” is not compatible with Macintosh computers.

Recommended computer environment

The following environment is recommended for a computer connected to the camera.

Recommended environment for copying images

OS (pre-installed): Mac OS X (v10.1.3 or later)

USB jack: Provided as standard

Recommended environment for using “Image Data Converter SR Ver.1.1”

OS (pre-installed): Mac OS X (v10.3-10.4)

CPU: iMac, eMac, iBook, PowerBook, Power Mac G4/G5 series, Mac mini

Memory: 256 MB or more (512 MB or more is recommended.)

Display: 1024 × 768 dots or more, 32,000 colors or more

Notes on connecting your camera to a computer

- Operations are not guaranteed for all the recommended computer environments mentioned above.
- If you connect two or more USB devices to a single computer at the same time, some devices, including your camera, may not operate depending on the types of USB devices you are using.
- Operations are not guaranteed when using a USB hub.
- Connecting your camera using a USB interface that is compatible with Hi-Speed USB (USB 2.0 compliant) allows advanced transfer (high speed transfer) as this camera is compatible with Hi-Speed USB (USB 2.0 compliant).

- Check that [Transfer mode] in the  Setup menu is set to [Mass Storage]. If it is set to [PTP], the camera is not recognized.
- When your computer resumes from the suspend or sleep mode, communication between your camera and your computer may not recover at the same time.

Copying and viewing images on a computer

1 Prepare the camera and a Macintosh computer.

Perform the same procedure as that described in “Stage 1: Preparing the camera and the computer” on page 107.

2 Connect the USB cable.

Perform the same procedure as that described in “Stage 2: Connecting the camera and your computer” on page 108.

3 Copy image files to the Macintosh computer.

- ① Double-click the newly recognized icon → [DCIM] → the folder where the images you want to copy are stored.
 - ② Drag and drop the image files to the hard disk icon.
The image files are copied to the hard disk.
- For details on the storage location of the images and file names, see page 112.

4 View images on the computer.

Double-click the hard disk icon → the desired image file in the folder containing the copied files to open that image file.

To delete the USB connection

Perform the procedures listed below beforehand when:

- Disconnecting the USB cable
- Removing a recording medium
- Turning off the camera

Drag and drop the drive icon or the icon of the recording medium to the “Trash” icon.

The camera is disconnected from the computer.

Installing “Image Data Converter SR Ver.1.1”

You can edit images recorded in RAW mode with various corrections, such as tone curve, sharpness. Also, you can save the images as a general-purpose file format.

- Log on as Administrator for installation.
- ① Turn on your Macintosh computer, and insert the CD-ROM (supplied) into the CD-ROM drive.
 - ② Double-click the CD-ROM icon.
 - ③ Copy the [IDCSR_INST.pkg] file in the [MAC] folder to the hard disk icon.
 - ④ Double-click the [IDCSR_INST.pkg] file in the copy-to folder.
Follow the instructions on the screen to complete the installation.
 - When the restarting confirmation message appears, restart the computer following the instructions on the screen.
- If you save the ARW format data as the RAW format, the data is converted to the SR2 format.

Starting up “Image Data Converter SR Ver.1.1”

Double-click [Image Data Converter SR] in the [Application] folder.

Technical Support

Additional information on this product and answers to frequently asked questions can be found at the Sony Customer Support Website.
<http://www.sony.net/>

How to print images

Printing directly using a PictBridge compliant printer (page 123)



You can print images by connecting the camera directly to a PictBridge compliant printer.

Printing directly using a “Memory Stick Duo”/CF card/Microdrive compliant printer



You can print images with a “Memory Stick Duo”/CF card/Microdrive compliant printer.
For details, see the operating instructions supplied with the printer.

Printing using a computer



You can copy images to a computer using the supplied “Picture Motion Browser” software and print the images.

Printing at a shop

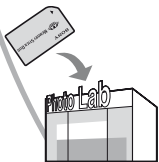

You can take a recording medium containing images shot with your camera to a photo printing service shop. You can make a  (DPOF set) mark on images that you want to print out in advance.

Printing images directly using a PictBridge compliant printer

Even if you do not have a computer, you can print images shot using your camera by connecting the camera directly to a PictBridge compliant printer.

PictBridge

- “PictBridge” is based on the CIPA standard. (CIPA: Camera & Imaging Products Association)

In single-image mode

You can print a single image on a printing sheet.



In index mode

You can print several images at a reduced size on a printing sheet.



- An index print function may not be provided depending on the printer.
- The quantity of images that can be printed as an index image differ depending on the printer.
- You cannot print RAW data files.

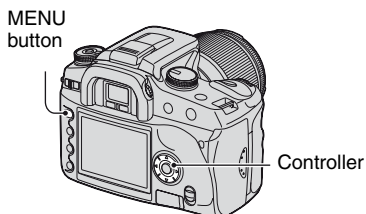

Stage 1: Preparing the camera

Prepare the camera to connect it to the printer with the USB cable.



- It is recommended to use the AC Adaptor/charger (not supplied) to prevent the power from turning off partway through printing.

1 Press **MENU** to display the menu.

2 Select [] (Setup) with  on the controller, then press the center of the controller (page 80).

3 Select [Transfer mode] with , then press .

4 Select [PTP] with , then press the center of the controller.

The USB mode is set to [PTP].

5 Turn the camera off and insert the recording medium that the images have been recorded.

Stage 2: Connecting the camera to the printer

1 Connect the camera to the printer.

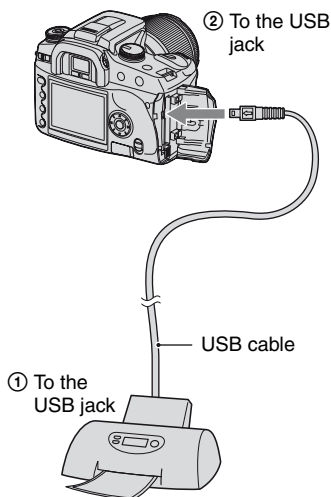

2 Turn on your camera and the printer.

The following screen appears.

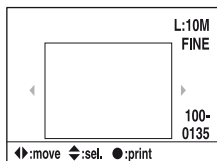

- If the screen does not appear, press the shutter button on the camera halfway down.

Stage 3: Printing

1 Select the image to print with ◀/▶ on the controller.

- When you want to print only one image, go to step 4.

2 Select the number of sheets with ▲/▼ on the controller.

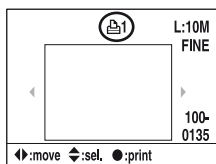

- The number increases up to 20 with ▲ and decreases with ▼.
- You can select the number of sheets for all the images at the same time (page 125).

3 Repeat steps 1 and 2 if you want to print other images.

- If you display other images, the total number of sheets is indicated in the "Total" field.

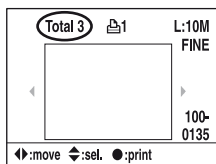

- You can switch between the single-image display and the index display with the (Display) button.
- You can enlarge the image with the ⊕ (Enlarge) button.

4 Press the center of the controller.

The print confirmation screen appears.

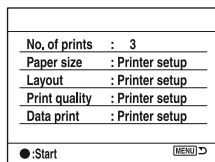

5 Press the center of the controller again.

The image is printed.

6 After the message “Printing finished.” appears, press the center of the controller.



To cancel the print

During printing, pressing the center of the controller cancels the print. Remove the USB cable or turn off the camera. When you want to print again, follow the procedure above.

To set up using the print menu

After you connect the camera to a printer, pressing the MENU button opens the following print menu. To operate the print menu, see page 80.

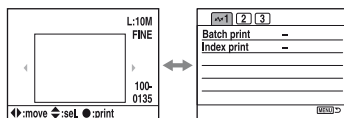

1 (Page 1)

[Batch print]

All images	Prints all the images in the recording medium in equal quantities.
Reset	Clears all the print settings.

- You can specify the number of prints up to 20.

[Index print]

Start	Prints all the images in the recording medium as an index print. The print confirmation screen appears. Pressing the center of the controller starts the printing operation.
-------	--

- For an index print, the number of images on one sheet, or the print format used depends on your printer.

2 (Page 2)**[Paper size]**

<input checked="" type="checkbox"/>	Printer setup
	9×13cm/3.5"×5"
	Hagaki card
	13×18cm/5"×7"
	A4/8.5"×11"
	2"×3" card
	10×15cm
	4"×6"
	8"×10"
	Letter

[Layout]

<input checked="" type="checkbox"/>	Printer setup
	Borderless
	1 image/sheet
	2 image/sheet
	4 image/sheet

[Print quality]

<input checked="" type="checkbox"/>	Printer setup
	Fine

[Data print]

<input checked="" type="checkbox"/>	Printer setup
	Off
	Date
	File name
	Date & name

3 (Page 3)**[DPOF Print]**

Start	Prints the DPOF-marked images that were specified in the  Playback menu, regardless of the image currently displayed. The print confirmation screen appears. Pressing the center of the controller starts the printing operation.
-------	--

Troubleshooting

If you experience trouble with your camera, try the following solutions. Check the items on pages 127 to 136. Consult your Sony dealer or local authorized Sony service facility.

Battery pack and power

The battery pack cannot be installed.

- As you insert the battery pack, use the tip of the battery pack to push the lock lever (→ *step 1 in "Read This First"*).
- Install the battery pack correctly (→ *step 1 in "Read This First"*).

The battery remaining indicator is incorrect, or sufficient battery remaining indicator is displayed but the power runs out too quickly.

- This phenomenon occurs when you use the camera in an extremely hot or cold location (page 142).
- The battery pack is discharged. Install the charged battery pack (→ *step 1 in "Read This First"*).
- The battery pack is dead (page 142). Replace it with new one.

The battery pack runs down too quickly.

- Charge it sufficiently (→ *step 1 in "Read This First"*).
- You are using the camera in an extremely cold location (page 142).
- The battery terminal is dirty. Clean the battery terminal with a cotton swab, etc., and charge the battery pack.
- The battery pack is dead (page 142). Replace it with new one.

Cannot turn on the camera.

- Install the battery pack correctly (→ *step 1 in "Read This First"*).
- The battery pack is discharged. Install charged battery pack (→ *step 1 in "Read This First"*).
- The battery pack is dead (page 142). Replace it with new one.

The power turns off suddenly.

- If you do not operate the camera for given period of time, the camera turns to power saving mode and nearly shuts down. To cancel the power save, operate the camera, such as pressing the shutter button halfway down (→ *step 3 in "Read This First"*).
- The battery pack is discharged. Install charged battery pack (→ *step 1 in "Read This First"*).

Shooting images

Nothing is displayed on the LCD monitor when the power is turned on.

- In the default setting, the LCD monitor will turn off if no operation is registered for more than five seconds to minimize the battery consumption. You can change the time setting (page 102).
- The LCD monitor is set to off. Press the  (Display) button to turn the LCD monitor on (page 26).
- Something, such as a hand, has activated the eyepiece sensors when it passed near the sensors. If the sensors below the viewfinder are activated, the camera turns off the LCD monitor assuming the photographer is using the viewfinder. You can deactivate this function (page 97).
- An exposure longer than one second, such as a bulb exposure, is being performed. Nothing is displayed on the LCD monitor during the exposure.

The image is not clear in the viewfinder.

- Adjust the diopter scale properly using the diopter-adjustment dial (→ *step 5 in “Read This First”*).

Your camera cannot record images.

- Check the free capacity of the recording medium (page 27). If it is full, do one of the following:
 - Delete unnecessary images (→ *step 6 in “Read This First”*).
 - Change the recording medium.
- You are using the “Memory Stick Duo” with the write-protect switch, and the switch is set to the LOCK position. Set the switch to the recording position (page 139).
- You cannot record images while charging the built-in flash.

The shutter does not release.

- The shutter cannot be released when the subject is out of focus. (The shutter lock can be deactivated (page 93).)
- The shutter cannot be released when the camera is attached to another device, such as an astronomical telescope, etc. (The shutter lock can be deactivated in this situation (page 96).)
- The shutter cannot be released with “----” flashing at the lower-right corner on the LCD monitor and “E” flashing in the viewfinder. This indication means a recording medium is not inserted in the camera. Insert a recording medium to take a picture (→ *step 4 in “Read This First”*).
- The shutter cannot be released with “--” lit at the upper-right corner on the LCD monitor. This indication means the lens is not attached properly. Attach the lens properly (→ *step 2 in “Read This First”*).

Recording takes a long time.

- The noise reduction function is activated (page 85). This is not a malfunction.
- You are shooting in RAW mode (page 83). Since the RAW data file is large, the RAW mode shooting may take time.

The image is out of focus.

- The subject is too close. Check the minimum focal distance of the lens.
- You are shooting in manual focus mode, set the focus mode switch to AF (page 71).
- You try to shoot a subject that may require special focusing (page 15). Use the focus-lock or manual focus function (page 71).

The flash does not work.

- The built-in flash is closed. Pull it up.
- The flash mode is set to [Autoflash]. If you want to make sure the flash fires without fail, set the flash mode to [Fill-flash] (page 54).

Fuzzy specks appear in images shot using the flash.

- Dust in the air reflected the flash light and appeared in the image. This is not a malfunction.

A picture taken with the flash is too dark.

- If the subject is beyond the flash range (the distance that the flash can reach), the pictures will be dark because the flash light does not reach the subject. If the ISO is changed, the flash range also changes with it (page 44).

The bottom of a picture taken with the flash is too dark.

- The picture was taken with the lens hood on. Remove the lens hood when the built-in flash is used. With some lenses, the bottom of the picture may become dark even without the lens hood (→ *step 5 in "Read This First"*).

The flash takes too long to recharge.

- The flash has been fired in succession in a short period. When the flash has been fired in succession, the recharging process may take longer than usual to avoid overheating of the camera.

The date and time are recorded incorrectly.

- Set the correct date and time (page 99, → *step 3 in "Read This First"*).

The aperture value and/or shutter speed flash when you press the shutter button halfway down.

- Since the subject is too bright or too dark, it is beyond the available range. Adjust the setting again.

The image is too dark.

- You are shooting a subject with a light source behind the subject. Select the metering mode (page 58) or adjust the exposure (pages 37, 65).
- The brightness of the screen is too low. Adjust the brightness of the LCD monitor (page 98).

The image is too bright.

- You are shooting a spotlighted subject in a dark location such as on a stage. Adjust the exposure (pages 37, 65).
- The brightness of the screen is too bright. Adjust the brightness of the LCD monitor (page 98).

Excessive light appears in the image.

- The picture was taken under a strong light source, and excessive light has entered the lens. Attach a lens hood.

The corners of the picture are too dark.

- If any filter or hood is used, take it off and try shooting again. Depending on the thickness of the filter and improper attachment of the hood, the filter or the hood may partially appear in the image. The optical properties of some lenses may cause the periphery of the image to appear too dark (insufficient light).

The eyes of the subject come out red.

- Activate the red eye reduction function (page 86).
- Get close to the subject, and shoot the subject within the flash range using the flash (→ *step 5 in "Read This First"*).
- Light the room and shoot the subject.

Dots appear and remain on the screen.

- This is not a malfunction. These dots are not recorded (page 8).

The image is blurred.

- The picture was taken in a dark location without the flash, resulting in camera-shake. The use of the Super SteadyShot function or a tripod is recommended. The flash can be used in this situation (page 14, → *step 5 in "Read This First"*).
- The picture of the subject was taken at a very short distance, such as in macro shooting. The Super SteadyShot function may not be fully effective when the subject is very near. In such a case, turn off the Super SteadyShot function and consider using a tripod (page 14, → *step 5 in "Read This First"*).
- The subject was moving quickly. Select a higher shutter speed or a higher ISO sensitivity (the higher the ISO sensitivity, the noisier the image).

The Ev scale ◀ ▶ is flashing in the viewfinder.

- The subject is too bright or too dark for the metering range of the camera.

An error is displayed when setting the custom white balance.

- The custom white balance was performed at too short a distance using the flash. Or the custom white balance was set with a vivid-colored subject. Be sure to put some distance between the camera and the subject when firing the flash. Choose a white subject when setting the custom white balance (page 48).

Viewing images

Refer to “Computers” (page 132) in conjunction with the following items.

Your camera cannot play back images.

- Press the  (Playback) button to turn to playback mode (→ *step 6 in “Read This First”*).
- The folder/file name has been changed on your computer (page 113).
- When an image file has been processed by a computer or when the image file was recorded using a model other than that of your camera, playback on your camera is not guaranteed.
- The camera is in USB mode. Delete the USB connection (page 111).

The image does not appear on the TV screen.

- Check [Video output] to see if the video output signal of your camera is set to the color system of your TV (page 98).
- Check whether the connection is correct (page 78).
- If a USB cable is connected to the camera, disconnect the USB cable (page 111).

Deleting/Editing images

Your camera cannot delete an image.

- Cancel the protection (page 89).
- You are using the “Memory Stick Duo” with the write-protect switch, and the switch is set to the LOCK position. Set the switch to the recording position (page 139).

You have deleted an image by mistake.

- Once you have deleted an image, you cannot restore it. We recommend that you protect images (page 89), or use the “Memory Stick Duo” with the write-protect switch and set the switch to the LOCK position (page 139) to prevent accidental erasure.

You cannot display a  (DPOF set) mark.

- You cannot display  (DPOF set) marks on RAW data files.

You cannot delete the folder in file browser index screen.

- Once the folder in the recording medium was displayed on a Windows computer, you may not be able to delete the folder. Delete the folder on a computer.

Computers

You do not know if the OS of your computer is compatible with the camera.

- Check “Recommended computer environment” on page 106 for Windows, and page 120 for Macintosh.

Your computer does not recognize your camera.

- Turn on the camera (→ *step 3 in “Read This First”*).
- When the battery level is low, install the charged battery pack (→ *step 1 in “Read This First”*), or use the AC Adaptor/charger (not supplied) (page 144).
- Use the USB cable (supplied) (page 108).
- Disconnect the USB cable, and connect it again firmly.
- Set [Transfer mode] to [Mass Storage] (page 98).
- Disconnect all equipment other than the camera, the keyboard and the mouse from the USB jacks of your computer.
- Connect the camera directly to your computer without passing through a USB hub or other device (page 108).

You cannot copy images.

- Make the USB connection by properly connecting the camera with your computer (page 108).
- Follow the designated copy procedure for your OS (pages 108, 120).
- When you shoot images with a recording medium formatted by a computer, you may not be able to copy the images to a computer. Shoot using a recording medium formatted by your camera (page 89).

After making a USB connection, “Picture Motion Browser” does not start automatically.

- Start “Media Check Tool” (page 115).
- Make the USB connection after the computer is turned on (page 107).

The image cannot be played back on a computer.

- If you are using “Picture Motion Browser”, refer to the Help.
- Consult the computer or software manufacturer.

You cannot print an image.

- Check the printer settings.

Images once copied to a computer cannot be viewed on the camera.

- Copy them to a folder recognized by the camera, such as “100MSDCF” (page 112).
- Operate correctly (page 113).

Picture Motion Browser

Images are not displayed correctly.

- Make sure the folder of the images is registered in “Viewed folders”. If the images are not displayed even if the folder is registered in “Viewed folders”, update the database (page 118).

You cannot find images imported.

- Look in the “My Pictures” folder.
- If you have changed the default settings, refer to “Changing the “Folder to be imported”” on page 118 and check what folder is used for importing.

You want to change the “Folder to be imported”.

- Access the “Import Settings” screen to change “Folder to be imported”. You can specify a different folder after using “Picture Motion Browser” to register it in “Viewed folders” (page 118).

All imported images are displayed on the calendar with the date January 1.

- The date has not been set on the camera. Set the date on the camera (page 99, → *step 3 in “Read This First”*).

“Memory Stick Duo”

Cannot insert a “Memory Stick Duo”.

- Use the Memory Stick Duo Adaptor for CF slot, then insert it (→ *step 4 in “Read This First”*).

Cannot record on a “Memory Stick Duo”.

- You are using the “Memory Stick Duo” with the write-protect switch, and the switch is set to the LOCK position. Set the switch to the recording position (page 139).
- The “Memory Stick Duo” is full. Delete unnecessary images (page 88, → *step 6 in “Read This First”*).

Cannot format a “Memory Stick Duo”.

- You are using the “Memory Stick Duo” with the write-protect switch, and the switch is set to the LOCK position. Set the switch to the recording position (page 139).

You have formatted a “Memory Stick Duo” by mistake.

- All the data on the “Memory Stick Duo” is deleted by formatting. You cannot restore it. We recommend that you set the write-protect switch on the “Memory Stick Duo” to the LOCK position to prevent accidental erasure (page 139).

“Memory Stick PRO Duo” is not recognized by a computer with a “Memory Stick” slot.

- If “Memory Stick PRO Duo” is not supported, connect the camera to the computer (pages 107 to 108). The computer recognizes the “Memory Stick PRO Duo”.

CF card/Microdrive

Cannot insert a CF card/Microdrive.

- Insert it in the correct direction (→ *step 4 in “Read This First”*).

Cannot record on a CF card/Microdrive.

- The CF card/Microdrive is full. Delete unnecessary images (page 88, → *step 6 in “Read This First”*).
- An unusable CF card is inserted (→ *step 4 in “Read This First”*).
- You are using the recording medium with the write-protect switch, and the switch is set to the LOCK position. Set the switch to the recording position.

The Microdrive is heated.

- You are using the Microdrive for a long time. This is not a malfunction.

You have formatted a CF card/Microdrive by mistake.

- All the data on the CF card/Microdrive is deleted by formatting. You cannot restore it.

Printing

Also see “PictBridge compliant printer” (as follows) in conjunction with the following items.

The color of the image is strange.

- When you print the images recorded in Adobe RGB mode using sRGB printers that are not compatible with Adobe RGB (DCF2.0/Exif2.21), the images are printed at a lower intensity level (page 50).

PictBridge compliant printer

A connection cannot be established.

- The camera cannot be connected directly to a printer that is not compliant with the PictBridge standard. Consult the printer manufacturer as to whether the printer is compliant with PictBridge or not.
- Check that the printer is turned on and can be connected to the camera.
- When a recording medium, such as a “Memory Stick Duo”, CF card, is not inserted to the camera the camera cannot connect to the printer. After you insert a recording medium, connect the printer again.
- Set [Transfer mode] to [PTP] (page 98).

- Disconnect and connect the USB cable again. If an error message is indicated on the printer, refer to the operating instructions supplied with the printer.

Cannot print images.

- Check that the camera and the printer are properly connected using the USB cable.
- Turn on the printer. For further information, refer to the operating instructions supplied with the printer.
- RAW data files cannot be printed.
- Images shot using cameras other than this camera or images modified with a computer may not be printed.

Cannot insert the date or print images in the index mode.

- The printer does not provide these functions. Consult the printer manufacturer as to whether the printer provides these functions or not.
- The date may not be inserted in the index mode depending on the printer. Consult the printer manufacturer.

“---- -- --” is printed on the date-inserted part of the image.

- Images that do not have the recording data cannot be printed with the date inserted. Set [Data print] to [Off] and print the image again (page 126).

Cannot select the print size.

- Consult the printer manufacturer as to whether the printer can provide the desired size.

Cannot print the image at the size selected.

- Disconnect the USB cable and reconnect it whenever you change the paper size after the printer has been connected to the camera.
- The print setting of the camera differs from that of the printer. Change the setting of either the camera (page 126) or the printer.

Cannot operate the camera after canceling printing.

- Wait for a while as the printer is carrying out the cancellation. It may take some time depending on the printer.

Others

Your camera does not work.

- Use the type of battery pack you can use with this camera (page 142).
- The battery level is low (The  indicator appears). Charge the battery pack (→ *step 1 in "Read This First"*).

The lens gets fogged.

- Moisture condensation has occurred. Turn off the camera and leave it for about an hour before using it (page 147).

The message "Set date and time?" appears when you turn on the camera.

- The camera has been left unused for sometime with a low battery or no battery pack. Change the battery pack and set the date again (→ *step 3 in "Read This First"*). If the date setting is lost every time the battery pack is changed, consult your Sony dealer or local authorized Sony service facility.

The number of recordable images does not decrease or decreases two at a time.

- This is because the compression rate and the image size after compression change depending on the image when you shoot with a JPEG image (page 83).

The setting is reset without the resetting operation.

- The battery pack was removed when the POWER switch was set to ON. When removing the battery pack, make sure the POWER switch is set to OFF and the access lamp is not illuminated (→ *step 1 in "Read This First"*).

The camera does not work properly.

- Turn off the camera. Remove the battery pack and insert it again. If an AC Adaptor/charger (not supplied) is used, disconnect the power cord. If the camera is hot, allow it to cool down before trying this corrective procedure.

The five bars of the Super SteadyShot scale flash.

- The Super SteadyShot function does not work. You can continue to shoot but the Super SteadyShot function will not work. Turn the camera off and on. If the Super SteadyShot scale continues to flash, consult your Sony dealer or local authorized Sony service facility.

"--E-" is indicated on the lower-right corner of the LCD monitor.

- Remove the recording medium, and insert it again. If this procedure does not turn off the indication, format the recording medium.

Warning messages

If the following messages appear, follow the instructions.

Incompatible battery. Use correct model.

- An incompatible battery pack is being used.

Battery exhausted.

- The battery pack is discharged. Charge the battery pack.

Set date and time?

- Set the date and time. If the message appears frequently, the internal backup battery is used up. Replace the battery (pages 136, 148).

Unable to use card. Format?

- The recording medium was formatted on a computer and the file format was modified, or the recording medium was formatted on another device. Select [Yes], then format the recording medium. You can use the recording medium again, however, all previous data in the recording medium is erased. It may take a some time to complete the format. If the message still appears, change the recording medium.

Card locked.

- The write-protect switch of the recording medium, such as a “Memory Stick Duo” is set to the LOCK position.

Card error.

- An incompatible recording medium is inserted.

Processing...

- When the shutter speed is one second or higher, or the camera is in bulb shooting mode, noise reduction will be done for the same amount of time that the shutter was open. You cannot do any further shooting during this reduction. You can also deactivate noise reduction.

No card.Custom shutter lock on.

- [Shutter lock] is set to [On: no card]. Set it to [Off: no card] or insert a recording medium.

No lens attached.

- [Shutter lock] is set to [On: no lens]. Set it to [Off: no lens] or attach a lens. When attaching the camera to an astronomical telescope or something similar, set it to [Off: no lens] in the  Custom menu.

Power insufficient. Operation canceled.

- You tried to perform [Clean CCD] when the battery level is insufficient. Charge the battery pack or use the AC Adaptor/charger (not supplied).

Unable to display.

- Images recorded with other cameras or images modified with a computer may not be able to be displayed.

No images.

- There is no image in the recording media.

No images selected.

- You tried to delete images without specifying which images you want to delete.

Image protected.

- You tried to delete protected images. Release the protection.

Unable to print.

- You tried to mark RAW images with a DPOF set mark.

**Initializing
USB connection.**

- A USB connection has been established. Do not disconnect the USB cable.

USB connection error

- A USB connection cannot be established. Disconnect the USB cable and connect it again.

Error. Check printer.

- There is a problem with the printer, such as a paper out condition.

Printing canceled.

- The print job was canceled. Disconnect the USB cable or turn the camera off.

**Camera overheating.
Allow it to cool.**

- The camera has become hot because you have been shooting continuously. Turn the power off. Cool the camera and wait until the camera is ready to shoot again.

**System error.
CAMERA ERROR CODE=□□□□ (□
is a number or letter of the alphabet)**

- Turn the power off, remove the battery pack, then re-insert it. If the message appears frequently, consult your Sony dealer or local authorized Sony service facility.

On the “Memory Stick”

A “Memory Stick” is a compact, portable IC recording medium. The types of “Memory Stick” that can be used with this camera are listed in the table below. However, proper operation cannot be guaranteed for all “Memory Stick” functions.

“Memory Stick” type	Recording/Playback
Memory Stick (without MagicGate)	—
Memory Stick (with MagicGate)	—
Memory Stick Duo (without MagicGate)	○
Memory Stick Duo (with MagicGate)	○*1*2
MagicGate Memory Stick	—
MagicGate Memory Stick Duo	○*1
Memory Stick PRO	—
Memory Stick PRO Duo	○*1*2

*1 “Memory Stick Duo”, “MagicGate Memory Stick Duo” and “Memory Stick PRO Duo” are equipped with MagicGate functions. MagicGate is copyright protection technology that uses encryption technology. Data recording/playback that requires MagicGate functions cannot be performed with this camera.

*2 Supports high-speed data transfer using a parallel interface.

- A “Memory Stick Duo” formatted with a computer is not guaranteed to operate with this camera.
- Data read/write speeds differ depending on the combination of the “Memory Stick Duo” and the equipment used.

Notes on using a “Memory Stick Duo” (not supplied)

- You cannot record, edit or delete images if you slide the write-protect switch to LOCK with a fine-tipped object.

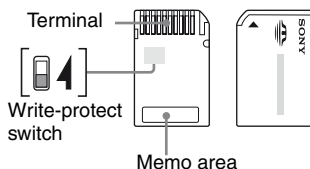

Some “Memory Stick Duo” cards do not have a write-protect switch. On “Memory Stick Duo” with this switch, the position and shape may vary depending on the “Memory Stick Duo”.

- Do not remove the “Memory Stick Duo” while reading or writing data.
- Data may be corrupted in the following cases:
 - When the “Memory Stick Duo” is removed or the camera is turned off during a read or write operation
 - When the “Memory Stick Duo” is used in locations subject to static electricity or electrical noise
- We recommend backing up important data.
- Do not press down hard when you write down on the memo area.
- Do not attach a label on the “Memory Stick Duo” itself nor on a Memory Stick Duo Adaptor.
- When you carry or store the “Memory Stick Duo”, put it in the case supplied with it.
- Do not touch the terminal section of the “Memory Stick Duo” with your hand or a metal object.
- Do not strike, bend or drop the “Memory Stick Duo”.
- Do not disassemble or modify the “Memory Stick Duo”.
- Do not expose the “Memory Stick Duo” to water.
- Do not leave the “Memory Stick Duo” within the reach of small children. They might accidentally swallow it.

- Do not use or store the “Memory Stick Duo” under the following conditions:
 - High temperature locations such as the hot interior of a car parked in direct sunlight
 - Locations exposed to direct sunlight
 - Humid locations or locations with corrosive substances present

Notes on using the Memory Stick Duo Adaptor for CF slot (supplied)

- When inserting a “Memory Stick Duo” into a Memory Stick Duo Adaptor for CF slot, make sure the “Memory Stick Duo” is inserted facing in the correct direction, then insert it all the way in. Incorrect insertion may result in a malfunction.
- When using a “Memory Stick Duo” inserted into a Memory Stick Duo Adaptor for CF slot with a compliant device, make sure that the Memory Stick Duo Adaptor for CF slot is inserted facing the correct direction. Note that improper use may damage the equipment.
- Do not insert a Memory Stick Duo Adaptor for CF slot into a compliant device without a “Memory Stick Duo” attached. Doing so may result in malfunction of the unit.
- When you insert a Memory Stick Duo Adaptor for CF slot into a CompactFlash - PC card adaptor and connect it to a PC card slot of a computer, proper operation is not guaranteed.
- The supplied Memory Stick Duo Adaptor for CF slot is only for use with this camera. You can use it with other devices, however, proper operation is not guaranteed.
- When removing a “Memory Stick Duo” from the Memory Stick Duo Adaptor for CF slot, push the “Memory Stick Duo” once. If you yank the “Memory Stick Duo” out without pushing in first, a malfunction may be caused.

Note on using “Memory Stick PRO Duo” (not supplied)

“Memory Stick PRO Duo” with a capacity up to 4 GB have been confirmed to operate properly with this camera.

On the CF card/Microdrive

- Be sure to format the recording medium using this camera when you use it for the first time.
- Data may be damaged in the following cases:
 - Removing the recording medium while reading or writing data.
 - If you store the recording medium near strongly-magnetized material.
- The recording medium may be hot just after it has been used. Be careful when you handle it.
- Do not remove the label or attach a new label over the label.
- When you carry or store the recording medium, put it in the case supplied with it.
- Do not expose the recording medium to water.
- Do not press on the label strongly.
- Do not touch the terminal section of the recording medium with your hand or a metal object.

Notes on use of the Microdrive

A Microdrive is a compact and lightweight hard disk drive that complies with CompactFlash Type II.

- The Microdrive is a compact hard disk drive. Since the Microdrive is a rotating disk, the Microdrive is not strong enough to resist vibration and shock compared to a “Memory Stick,” which uses flash memory. Be sure not to transmit vibration or shock to the Microdrive during playback or shooting.
- Note that the use of the Microdrive under 5°C (41°F) may bring performance degradation. Operating temperature range when using the Microdrive: 5 to 40°C (41 to 104°F)
- Note that the Microdrive cannot be used under low atmospheric pressure (above 3 000 meters above sea-level).
- Do not write on the label.

On the battery pack

Use only an NP-FM55H battery pack. Note that the NP-FM50 and NP-FM30 cannot be used.

- The battery life varies according to how it is stored and the operating conditions and environment in which each battery pack is used.

On charging the battery pack

We recommend charging the battery pack in an ambient temperature of between 10 to 30°C (50 to 86°F). You may not be able to efficiently charge the battery pack outside of this temperature range.

Effective use of the battery pack

- Battery performance decreases in low temperature surroundings. So, the time that the battery pack can be used is shorter in cold places. We recommend the following to ensure longer battery pack use:
 - Put the battery pack in a pocket close to your body to warm it up, and insert it in your camera immediately before you start shooting.
- The battery pack will run out quickly if you use the flash frequently.
- We recommend having spare battery packs handy, and making trial shots before taking the actual shots.
- Do not expose the battery pack to water. The battery pack is not water-resistant.
- Do not leave the battery pack in extremely hot places, such as in a car or under direct sunlight.

On the remaining battery indicator

When using the camera with the battery pack, the remaining time in minutes is not indicated.

How to store the battery pack

If the battery pack is not to be used for a long time, fully charge it and then fully use it up once a year on your camera before storing the battery pack in a dry, cool place. Repeat this charging and using up once a year to maintain the battery pack's function.

On battery life

- The battery life is limited. Battery capacity decreases little by little as you use it more and more, and as time passes. If the battery operating time seems shortened considerably, a probable cause is that the battery pack has reached the end of its life. Buy a new battery pack.

On the battery charger

■ On the battery charger

- Do not charge any battery pack other than the NP-FM series battery pack in the battery charger (supplied) with your camera. Batteries other than the specified kind may leak, overheat, or explode if you attempt to charge them, posing a risk of injury from electrocution and burns.
- Remove the charged battery pack from the battery charger. If you leave the charged battery pack in the charger, battery life may be decreased.
- When the CHARGE lamp flashes, this may indicate a battery error or that a battery pack other than the specified type have been inserted. Check that the battery pack is the specified type. If the battery pack is the specified type, remove the battery pack, replace it with new one or another one and check if the battery charger operates correctly. If the battery charger operates correctly, a battery error may have occurred.
- If the battery charger is dirty, charging may not be performed successfully. Clean the battery charger with dry cloth, etc.

Optional accessories

This section introduces how to connect and operate popular accessories for this camera. For details, refer to the operating instructions of each of the accessories.

AC-VQ900AM AC Adaptor/charger

When a household power outlet (AC power) is available, using an AC Adaptor/charger eliminates the possibility of running out of battery.

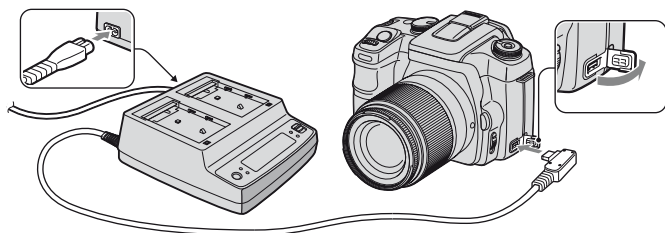

To connect the adaptor, set the POWER switch of the camera to OFF, flip open the cover, and insert the plug of the AC Adaptor/charger into the DC-IN terminal.

- When disconnecting the AC Adaptor/charger from the camera, turn the power off beforehand.
- You cannot use any AC adaptor other than the AC-VQ900AM.

RM-S1AM Remote Commander

This Remote Commander allows you to release the shutter without touching the camera. This keeps the camera from shaking. In addition, you can keep the shutter button down during bulb exposure (page 40).

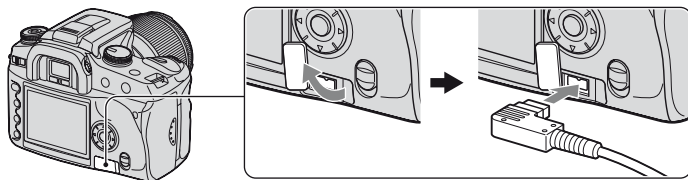

To attach the Remote Commander, flip open the cover of the REMOTE (remote-control) jack and insert the plug of the Remote Commander.

- As shown in the illustration above, flip the cover open from the right side and turn it counterclockwise. After use, turn it clockwise to replace the cover.

With the Remote Commander clip attached to the shoulder strap, you can catch the cord to secure it.

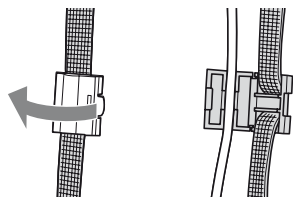

HVL-F56AM/HVL-F36AM Flash

A powerful flash can cover a longer distance than the built-in flash can, enabling flash shooting that produces beautiful images.

Flash HVL-F56AM

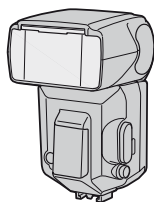

When using the flash (not supplied), remove the accessory shoe cap and slide the flash onto the camera. The removed cap can be placed on the eyepiece cover.



High Speed Sync (HSS) Shooting

You can perform high speed sync shooting with a HVL-F56AM or a HVL-F36AM.

With a flash HVL-F56AM or HVL-F36AM mounted on the camera and “HSS” appearing on the LCD window of the flash, the limitation on the flash sync speed* is canceled, enabling you to perform flash shooting across every shutter speed available with this camera (30 ~ 1/4000 second). This means you have a wider option of aperture values. Even with the flash,

you can widen the aperture to blur the background and accentuate the subject, producing a perfect portrait picture.

In addition, when using the flash with the aperture open in aperture priority mode or manual exposure mode, you can attain a proper exposure using the high speed flash even on a scene with a very bright background, which would normally cause overexposure.

* This camera's flash sync speed is 1/125 second with the Super SteadyShot on and 1/160 second with the Super SteadyShot off. The shutter speed will not be faster in other flash shooting than high speed sync.

- In high speed sync mode (when the shutter speed is faster than the flash sync speed noted above), "H" appears in the viewfinder and on the LCD monitor.
- In high speed sync mode, the flash range is shorter than in normal flash shooting. Before taking a picture, make sure the subject is within the range of distance displayed on the flash window.
- High speed sync mode is not available when the two-second self-timer or [Rear sync.] is selected.
- If a flash meter or a color meter is used, high speed sync mode is not available because the proper exposure cannot be attained. Either deactivate the high speed sync mode ("HSS" does not appear on the LCD window of the flash) or select a shutter speed slower than the flash sync speed.

FDA-A1AM Angle Finder/FDA-M1AM Magnifier

When using the Angle Finder or Magnifier, remove the eyecup.

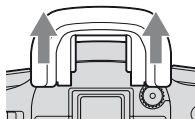

- The eyepiece sensors located below the viewfinder may be activated. Setting [Eye-Start AF] to [Off] is recommended (page 85).

Precautions

■ Do not use/store the camera in the following places

- In an extremely hot, dry or humid place
In places such as in a car parked in the sun, the camera body may become deformed and this may cause a malfunction.
- Under direct sunlight or near a heater
The camera body may become discolored or deformed, and this may cause a malfunction.
- In a location subject to rocking vibration
- Near strong magnetic place
- In sandy or dusty places
Be careful not to let sand or dust get into the camera. This may cause the camera to malfunction, and in some cases this malfunction cannot be repaired.

■ On carrying

Be sure to attach the lens cap or body cap when not using the camera. When attaching the body cap, remove all the dust from the cap before placing it on the camera.

■ On cleaning

Cleaning the LCD monitor

Wipe the screen surface with an LCD cleaning kit (not supplied) to remove fingerprints, dust, etc.

Cleaning the lens

- When cleaning the lens surface, remove dust using a blower brush. In case of dust that sticks to the surface, wipe it off with a soft cloth or tissue paper slightly moistened with lens cleaning solution. Wipe in a spiral pattern from the center to the outside. Do not spray lens cleaning solution directly onto the lens surface.
- Do not touch the inside of the camera, such as the shutter curtain, lens contacts, or the mirror. Since dust on the mirror or around the mirror may affect the auto focus system, blow away dust using a blower. If dust lands on the CCD, it may appear on the photo image. Turn the camera to the cleaning mode (page 103), then clean it using a blower. Do not use a spray blower to clean the inside of the camera. Using this may cause a malfunction.
- Do not use a cleaning solution containing organic solvents, such as thinner, or benzene.

Cleaning the camera surface

Clean the camera surface with a soft cloth slightly moistened with water, then wipe the surface with a dry cloth. Do not use the following as they may damage the finish or the casing.

- Chemical products such as thinner, benzene, alcohol, disposable cloths, insect repellent, sunscreen or insecticide, etc.
- Do not touch the camera with the above on your hand.
- Do not leave the camera in contact with rubber or vinyl for a long time.

■ On operating temperatures

Your camera is designed for use under the temperatures between 0 and 40°C (32 and 104°F) (When using a Microdrive: 5 and 40°C (41 and 104°F)). Shooting in extremely cold or hot places that exceed this range is not recommended.

■ On moisture condensation

If the camera is brought directly from a cold to a warm location, moisture may condense inside or outside the camera. This moisture condensation may cause a malfunction of the camera.

Moisture condensation occurs easily when:

- The camera is brought from a cold location such as a ski slope into a warmly heated room.
- The camera is taken from an air-conditioned room or car interior to the hot outdoors, etc.

How to prevent moisture condensation

When bringing the camera from a cold place to a warm place, seal the camera in a plastic bag and allow it to adapt to conditions at the new location over about an hour.

If moisture condensation occurs

Turn off the camera and wait about an hour for the moisture to evaporate. Note that if you attempt to shoot with moisture remaining inside the lens, you will be unable to record clear images.

■ On the internal rechargeable battery

This camera has an internal rechargeable battery for maintaining the date and time and other settings regardless of whether the power is on or off.

This rechargeable battery is continually charged as long as you are using the camera. However, if you use the camera for only short periods, it discharges gradually, and if you do not use the camera at all for about 8 months it becomes completely discharged. In this case, be sure to charge this rechargeable battery before using the camera.

However, even if this rechargeable battery is not charged, you can still use the camera as long as you do not record the date and time.

Charging method of the internal rechargeable battery

Insert a charged battery pack in the camera, or connect the camera to a wall outlet (wall socket) using the AC Adaptor/charger (not supplied), and leave the camera for 24 hours or more with the power off.

Charging method of the NP-FM55H battery pack

→ *step 1 in "Read This First"*

Specifications

Camera

[System]

Camera Type Digital Single Lens Reflex
Camera with built-in flash and interchangeable lenses

Lens All of Sony Lens

[CCD]

Total pixel number of camera
Approx. 10 800 000 pixels

Effective pixel number of camera
Approx. 10 200 000 pixels

Image sensor 23.6×15.8 mm (APS-C format)
Interlace scan Primary Color

[Super SteadyShot]

System CCD-Shift mechanism

Super SteadyShot Compensation capability
Approximately 2 EV to 3.5 EV
decrease in shutter speed
(varies according to shooting
conditions and lens used)

[Anti-Dust]

System Charge protection coating on
Low-Pass Filter and CCD-Shift
mechanism

[Viewfinder]

Type Fixed eye-level system with
roof mirror type pentaprism

Focusing Screen Spherical Acute Matte

Field of View 0.95

Magnification 0.83 × with 50 mm lens at
infinity, -1 m^{-1}

Eye Relief Approximately 20 mm from the
eyepiece, 16 mm from the
eyepiece frame at -1 diopter
(-1 m^{-1})

Dioptr Adjustment
 -2.5 to $+1.0 \text{ m}^{-1}$

[Auto Focus System]

System TTL phase-detection system,
CCD line sensors (9 points, 8
lines with center cross-hair
sensor)

Sensitivity Range
0 EV to 18 EV (at ISO 100
equivalent)

[Exposure]

Metering Cell 40-segment honeycomb-pattern
SPC

Metering Range +1 EV to +20 EV (+4 EV to
+20 EV with Spot metering),
(at ISO 100 with F1.4 lens)

[Shutter]

Type Electronically-controlled,
vertical-traverse, focal-plane
type

Speed range 1/4000 second to 30 seconds,
bulb

Flash Sync Speed
1/160 second (with Super
SteadyShot off),
1/125 second (with Super
SteadyShot on)

[Built-In-Flash]

Flash G.No. GN 12 (in meters at ISO 100)

Recycling Time Approx. 3 seconds

[Recording media]

CompactFlash card(TypeI,II),
Microdrive, "Memory Stick
Duo" (with Memory Stick Duo
Adaptor for CF Slot)

[LCD monitor]

LCD panel 6.2 cm (2.5 type) TFT drive

Total number of dots
230 000 (960×240) dots

[Power, general]

Used battery pack
Rechargeable battery pack
NP-FM55H

[Others]

PictBridge Compatible

Exif Print Compatible

PRINT Image Matching III
Compatible

Dimensions 133.1 × 94.7 × 71.3 mm
(5 1/4 × 3 3/4 × 2 7/8 inches)
(W/H/D, excluding protrusions)

Mass Approx. 545 g (1 lb 3.2 oz)
(without batteries, recording
medium and body accessories)

Operating temperature
0 to +40°C (+32 to +104°F)
(When using the Microdrive:
+5 to +40°C (41 to +104°F))

Exif Exif Ver. 2.21

USB communication
Hi-Speed USB (USB 2.0
compliant)

BC-VM10 Battery charger

Input rating 100 V to 240 V AC, 50/60 Hz

Output rating 8.4 V DC, 750 mA

Operating temperature range
0 to +40°C (32 to +104°F)

Storage temperature range
-20 to +60°C (-4 to +140°F)

Maximum dimensions
Approx. 70 × 25 × 95 mm
(2 7/8 × 1 × 3 3/4 inches) (W/H/
D)

Mass Approx. 90 g (3.2 oz)

Rechargeable battery pack NP-FM55H

Used battery Lithium-ion battery

Maximum voltage
DC 8.4 V

Nominal voltage DC 7.2 V

Capacity 11.5 Wh (1 600 mAh)

Maximum dimensions
Approx. 38.2 × 20.5 × 55.6 mm
(1 9/16 × 13/16 × 2 1/4 inches)
(W/H/D)

Mass Approx. 78 g (2.8 oz)

Design and specifications are subject to change
without notice.

Reset default

●: reset

○: not reset

* → Pages on the “Read This First”

Using the dial or button

Items	Reset to	A	B	C	D	Page
Super SteadyShot	—	○	○	○	○	14*
Adjusting the diopter	—	○	○	○	○	17*
Recording display	Detailed display	○	○	○	●	26
Exposure mode	—	—	—	○	○	33
ISO/Zone Matching	AUTO	●	●	●	●	44
White balance	AWB (Auto white balance)	●	●	●	●	46
Preset white balance	Daylight ±0	—	—	●	●	46
Color temperature/CC filter	5500K, CC filter ±0	—	—	●	●	47
Custom white balance	Daylight ±0	—	—	○	●	48
D-Range Optimizer	Standard	●	●	●	●	49
Color mode/Contrast/ Saturation/Sharpness	Standard/±0/±0/±0	● ³⁾	● ³⁾	●	●	49
AF area	Wide AF area	●	○	●	●	51
AF mode (AF-S/DMF/AF-A/AF-C)	AF-A	●	● ²⁾	●	●	53
Flash mode	Autoflash	● ⁴⁾	● ⁴⁾	● ⁴⁾	● ⁴⁾	54
Flash compensation	±0.0	●	●	●	●	57
Metering mode	Multi segment (40-segment honeycomb pattern metering)	●	●	●	●	58
Drive mode	Single-image advance	●	● ¹⁾	●	●	60
Exposure compensation	±0.0	●	●	●	●	65
Focus mode (MF/AF)	—	○	○	○	○	71
Playback display	Single-image screen (with recording data)	○	○	○	●	72

A: AUTO shooting (page 31)

B: Scene Selection (page 32)

C: Reset of recording function (page 87)

D: Reset default (page 104)

1) “Continuous” when in Sports action mode.

2) “AF-C” when in Sports action mode, “AF-S” when in Macro mode.

3) “A setting that the camera recommends” when in AUTO or Scene Selection.

4) “Autoflash” or “Fill-flash”. (“Rear sync.” or “Wireless” is canceled.)

Recording menu

Items	Reset to	A	B	C	D	Page
Image size	L:10M	○	○	○	●	83
Quality	Fine	○	○	○	●	83
Inst.Playback	2 sec.	○	○	○	●	84
Noise reductn	On	○	○	○	●	85
Eye-Start AF	On	○	○	○	●	85
Red eye	Off	○	○	○	●	86
Flash control	ADI flash	●	○	○	●	86
Flash default	Autoflash	○	○	○	●	86
Bracket order	0 → - - → +	○	○	○	●	87

A: AUTO shooting (page 31)

B: Scene Selection (page 32)

C: Reset of recording function (page 87)

D: Reset default (page 104)

Playback menu

Items	Reset to	A	B	C	D	Page
Index format	File browser	○	○	○	●	90
DPOF set	—	○	○	○	○	91
Date imprint	Off	○	○	○	●	92
Index print	—	—	—	—	—	92

A: AUTO shooting (page 31)

B: Scene Selection (page 32)

C: Reset of recording function (page 87)

D: Reset default (page 104)

Custom menu

Items	Reset to	A	B	C	D	Page
Priority setup	AF	●	●	○	●	93
FocusHoldButt.	Focus hold	○	○	○	●	93
AEL button	AE hold	○	○	○	●	93
Ctrl dial set	Shutter speed	○	○	○	●	94
Exp. comp. set	Ambient&flash	○	○	○	●	95
AF illuminator	On	○	○	○	●	95
Shutter lock	Off: no card	○	○	○	●	96
Shutter lock	On: no lens	○	○	○	●	96
AF area setup	0.3s. display	○	○	○	●	96
Monitor Disp.	Automatic	○	○	○	●	97
Rec. display	Auto rotate	○	○	○	●	97
Play. display	Auto rotate	○	○	○	●	97

A: AUTO shooting (page 31)

B: Scene Selection (page 32)

C: Reset of recording function (page 87)

D: Reset default (page 104)

Setup menu

Items	Reset to	A	B	C	D	Page
LCD brightness	Standard	○	○	○	●	98
Transfer mode	Mass Storage	○	○	○	●	98
Video output	—	○	○	○	○	98
Audio signals	On	○	○	○	●	99
Date/Time set	—	○	○	○	○	99
File # memory	On	○	○	○	●	100
Folder name	Std. form	○	○	○	●	100
Select folder	—	○	○	○	○	101
LCD backlight	5 sec.	○	○	○	●	102
Power save	3 min.	○	○	○	●	102
MenuSec.Memory	Off	○	○	○	●	102
Delete conf.	“No”	○	○	○	●	103

A: AUTO shooting (page 31)

B: Scene Selection (page 32)

C: Reset of recording function (page 87)

D: Reset default (page 104)

Index

Numerics

40-segment honeycomb pattern
metering59

A

AC Adaptor/charger.....144

Access lamp
→ *step 4 in "Read This
First"*

Accessory shoe cap.....145

ADI flash86

Adjusting exposure65

Adjusting the diopter
→ *step 5 in "Read This
First"*

Adobe RGB50

AE lock67

AEL button93

AF area.....51

AF area setup.....96

AF illuminator95

AF lock
→ *step 5 in "Read This
First"*

AF mode53

Ambient bracket.....63

Aperture16

Aperture priority34

Attaching a lens
→ *step 2 in "Read This
First"*

Audio signals99

Auto adjustment mode
→ *step 5 in "Read This
First"*

Auto Focus.....13

Autoflash55

Automatic AF53

B

B&W.....50

Battery charger
→ *step 1 in "Read This
First"*

Battery pack
Charging
→ *step 1 in "Read This
First"*

Insert/Remove
→ *step 1 in "Read This
First"*

Remaining indicator
→ *step 1 in "Read This
First"*

Blur.....14

Bracket order87

BULB shooting40

C

Camera-shake warning
→ *step 5 in "Read This
First"*

CC filter.....47

CD-ROM.....115, 121

Center weighted58

Charging battery pack
→ *step 1 in "Read This
First"*

Clean CCD103

Cleaning147

Cloudy47

Color.....17

Color temperature47

Color/DEC49

Compression ratio18, 83

Computer.....105

Copying images .. 107, 120

Macintosh.....120

Recommended
environment106, 120

Software114, 115

Viewing image files stored
on a computer with your
camera113

Windows105

Connecting

Computer.....108

Printer.....124

TV78

Continuous AF.....54

Continuous bracket.....62

Continuous shooting.....61

Contrast.....50

Copying images to your
computer.....107, 120

Ctrl dial set94

Custom menu 193

Custom menu 2.....96

Custom white balance.....48

D

Date imprint.....92

Date/Time set.....99

→ *step 3 in "Read This
First"*

Daylight47

DC-IN terminal.....144

Delete.....88

→ *step 6 in "Read This
First"*

Delete conf.....103

Depth-of-field preview70

Direct Manual Focus53

DirectX106

DPOF set91

D-Range Optimizer49

Drive mode60

E

Effective pixels149

Enlarge.....77

Ev scale.....38, 63, 67

Exposure16

Exposure Bracket.....62

Extension112, 113

External flash.....55, 145

Eye-cup 41
Eyepiece cover 41
Eye-Start AF 85

F

File # memory 100
File browser 72
File name 112
File storage destination 112
Fill-flash 55
Fine 83
Flash 47
Flash compensation 57
Flash control 86
Flash mode 54, 86
 → *step 5 in "Read This First"*

Flash range 44, 57
Fluorescent 47
F-number 34
Focus 13
Focus mode 51
FocusHoldButt 93
Focus-lock 14
Folder name 100
Format 89

H

Hi200 45
High Speed Sync shooting 145
Histogram display 74
Holding the camera
 → *step 5 in "Read This First"*

I

Identifying parts 19
Image Data Converter SR
 119, 121
Image file storage destinations
 and file names 112

Image quality 17, 83
Image size 17
Index format 90
Index print 92, 123
Index screen 72
Indicator see "Screen"
Inst.Playback 84
Install 114, 121
Internal rechargeable battery
 148
ISO 44

J

JPEG 83
JPG 112

L

Landscape (Color/DEC) 50
Landscape (Scene Selection)
 32
Language 99
 → *step 3 in "Read This First"*
LCDbrightness 98
Lo80 45
Local focus frame 52
Locking exposure 67
Long exposure shooting 40
Luminance limit warning 74

M

Macintosh computer 120
 Recommended
 environment 120
Macro 32
Manual exposure 37
Manual focus 71
Manual shift 39
Mass Storage 98
"Memory Stick Duo" 139

Menu 80
 Custom menu 1 93
 Custom menu 2 96
 Playback menu 1 88
 Playback menu 2 91
 Recording menu 1 83
 Recording menu 2 86
 Setup menu 1 98
 Setup menu 2 100
 Setup menu 3 102
MenuSec.Memory 102
Metering mode 58
Moisture condensation 147
Monitor Disp. 97
MultiSegment 58

N

New folder 101
Night portrait 33
Night view (Color/DEC) 50
Night view (Scene Selection)
 33
Noise reduction 85
Number of images 27

O

OS 106, 120
Overexposure 16

P

PC see "Computer"
PictBridge 123
Picture Motion Browser 114
Pixel 17
Play. display 97
Playback menu 1 88
Playback menu 2 91
Portrait (Color/DEC) 50
Portrait (Scene Selection) 32

Power cord	
→ step 1 in “Read This First”	
Power save	102
→ step 3 in “Read This First”	
Precautions.....	147
Pre-flash TTL.....	86
Preset white balance	46
Pressing halfway down	13
→ step 5 in “Read This First”	
Print	122
Index mode	123
Single-image mode.....	123
Printing directly	123
Priority setup.....	93
Program auto shooting.....	31
Program Shift.....	33
Protect.....	89

R

RAW	84
Rear sync.	55
Recording information display	22, 26, 97
Recording medium	
Insert/Remove	
→ step 4 in “Read This First”	
Number of images	27
Recording menu 1.....	83
Recording menu 2.....	86
Red eye	86
Release.....	93
Remote Commander	144
Reset	87
Reset default	104
Rotate.....	76

S

Saturation.....	50
-----------------	----

Scene Selection	32
Screen	
Changing the display	26
Indicator	22
Select folder	101
Self-timer	62
Set the clock	
→ step 3 in “Read This First”	
Setup menu 1.....	98
Setup menu 2.....	100
Setup menu 3.....	102
Shade.....	47
Sharpness	50
Shooting image	
→ step 5 in “Read This First”	
Shoulder strap	21
Shutter lock	96
Shutter speed	16
Shutter speed priority	36
Single bracket.....	63
Single-image mode printing	123
Single-shot AF	53
Slide show	91
Slow Sync.....	69
Software	114, 115
Specifications	149
Sports action.....	32
Spot	59
Spot focus frame	52
sRGB.....	50
Standard (Color/DEC).....	50
Standard (Image quality).....	83
Sunset (Color/DEC)	50
Sunset (Scene Selection).....	32
Super SteadyShot scale	
→ step 5 in “Read This First”	

T

Transfer mode.....	98
Troubleshooting.....	127
Tungsten	47
TV.....	78

U

Underexposure.....	16
USB cable.....	108, 124
Using your camera abroad	
→ step 1 in “Read This First”	

V

Video output	98
Viewing image.....	72
→ step 6 in “Read This First”	
Vivid	50



W

Warning messages	137
White balance	46
White balance bracket	64
Wide focus frame.....	52
Windows computer	105
Recommended environment.....	106
Wireless flash.....	55
Write-protect switch	139

Z

Zone Matching.....	45
Zoom	
→ step 5 in “Read This First”	

Trademarks

- α is a trademark of Sony Corporation.
- “Memory Stick”, , “Memory Stick PRO”, **MEMORY STICK PRO**, “Memory Stick Duo”, **MEMORY STICK DUO**, “Memory Stick PRO Duo”, **MEMORY STICK PRO DUO**, “MagicGate”, and **MAGIC GATE** are trademarks of Sony Corporation.
- Microsoft, Windows, and DirectX are either registered trademarks or trademarks of Microsoft Corporation in the United States and/or other countries.
- Macintosh, Mac OS, iMac, iBook, PowerBook, Power Mac, and eMac are trademarks or registered trademarks of Apple Computer, Inc.
- Intel, MMX, and Pentium are trademarks or registered trademarks of Intel Corporation.
- CompactFlash is a trademark of SanDisk Corporation.
- Microdrive is a registered trademark of Hitachi Global Storage Technologies in the United States and/or other countries.
- Adobe is a registered trademark or a trademark of Adobe Systems Incorporated in the United States and/or other countries.
- D-Range Optimizer Advanced uses technology provided by  Apical Limited.
- In addition, system and product names used in this manual are, in general, trademarks or registered trademarks of their respective developers or manufacturers. However, the TM or ® marks are not used in all cases in this manual.

